



# Sontec Instruments®

A TRADITION OF FINE SURGICAL INSTRUMENTS

PLASTIC ENT CATALOG

Dear Customer,

Sontec Instruments, Inc. is a family owned & operated medical company, providing personalized service featuring the finest in surgical instrumentation for over half a century.

Our surgical instruments encompass the entire human anatomy including specialty products specific to small and large animal surgery.

Owner of Sontec Instruments, Dennis Russell Scanlan III and his sons, Johann, Stefan and Angus Scanlan bring with them a lifetime of experience creating the highest quality products made by the world's leading manufacturing facilities featuring, cutting edge robotic technology, handmade workmanship combined with an understanding how to make exactly what our valued customers have come to expect.

Dennis R. Scanlan, III President & CEO and his wife Caron C. Scanlan thank you, for the opportunity to present our specialty Plastic ENT catalog.

Sincerely,



Dennis Russell Scanlan III

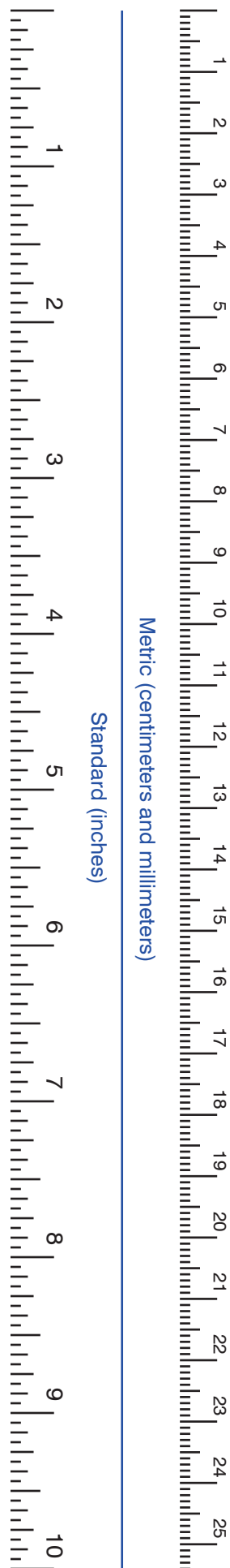

- |         |             |
|---------|-------------|
| • 1 mm  | • 2 french  |
| ○ 2 mm  | ○ 4 french  |
| ○ 3 mm  | ○ 6 french  |
| ○ 4 mm  | ○ 8 french  |
| ○ 5 mm  | ○ 10 french |
| ○ 6 mm  | ○ 12 french |
| ○ 7 mm  | ○ 14 french |
| ○ 8 mm  | ○ 16 french |
| ○ 9 mm  | ○ 18 french |
| ○ 10 mm | ○ 20 french |
|         | ○ 22 french |

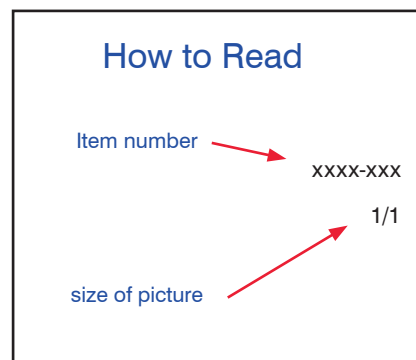

## Table of Contents

KNIFE & BLADE Handles .....	7
Scissors .....	11
Needle Holders.....	61
Forceps .....	91
ENT CURETTES .....	149
GOUGES .....	157
ENT Plastic OSTEOTOMES .....	165
ENT Plastic ELEVATORS .....	177
ENT Plastic SUCTION ELEVATORS.....	195
ENT SPECULUMS .....	199
ENT Plastic HOOKS .....	213
ENT Plastic DISSECTORS .....	233
Plastic Liposuction Cannulas .....	237
ENT Plastic RETRACTORS.....	243
Plastic Endoscopic Face Lifting .....	285
ENT RONGEURS .....	289
ENT KNIVES .....	299
CALIPERS & RULERS.....	307
RASPS .....	315
Plastic SPECIALTY .....	329
Ligature Carriers .....	347
SUCTION Selection .....	353
ENT SAWS .....	373
Eye OCULAR PLASTIC.....	377
Orthopedic MALLETS.....	405
Orthopedic SINGLE ACTION RONGEURS .....	409
Index .....	436

## Important Information

### Guarantee & Repairs Policy

Sontec® surgical instruments are guaranteed to be free of defects in materials and workmanship. Any Sontec® instrument that is defective will be repaired or replaced at our discretion. Instruments not properly cared for, used for unintended purposes, or beyond their designed capacity will not be covered under this guarantee. Our liability under this guarantee is limited to the repair or replacement of the defective merchandise.

Sontec® has its own repair department where most mechanically functional instruments can be returned to like-new condition.

Sontec® performs a variety of repairs, such as replacing worn TC jaws or sharpening scissors. In addition, we complete a comprehensive evaluation of your instruments to determine if further service is required.

For repair service, please send the following directly to the address below:

- Instruments clean, sterilized, securely wrapped and carefully packaged.
- Purchase and/or repair order
- A note with contact and shipping information
- Sending multiple items eliminates \$50 minimum charge

### Return Policy

The return of new, unused instruments in their original packaging is accepted within 30 days of purchase with an authorized "Return Merchandise Authorization". Please contact Sontec directly by phone or email with your invoice or proof of purchase in order to obtain your RMA slip and instructions. Restocking fee applies and credit will not be issued for shipping charges or handling fees. Proper credit is not guaranteed without an RMA. Custom, Special Order or Modified items are non-returnable.

Sontec Instruments, Inc.  
Toll free: 800.821.7496  
Local: 303.790.9411  
returns@sontecinstruments.com

### Remember

Sontec® offers other catalogs for a variety of surgical instrumentation, including:

- Alligator, Grasping, & Biopsy Forceps
- Avian & Exotic
- Bandage Scissors
- Cardiovascular & Thoracoscopic
- Caspar & Cloward Retractor Systems
- Colon & Rectal
- Cranial Cruciate Ligament Lateral Suture

#### System

- Equine (Arthroscopic)
- Eye
- Neurology & Orthopedic
- Orthopedic & Arthroscopic
- Urology
- Veterinary Dental
- Veterinary Eye
- General Veterinary Instrumentation

Also, if you do not find what you are looking for, please contact us.

### Instrument Care

Designed and crafted to exacting specifications, surgical instruments will perform for a number of years, provided they are maintained correctly and used for their intended purpose. A strict maintenance schedule will help reduce the need for premature replacements, thus cutting costs. For proper safeguarding of surgical instruments, please read and share the following information.

- Never substitute sterilization for cleanliness
- Wash brand new instruments prior to the first sterilization
- Remove saline solution, bleach, blood and tissue from instruments quickly and thoroughly
- Always use distilled water for cleaning instruments
- Never use saline solution for cleaning instruments
- Prevent cross-corrosion by separating corroded instruments from other instruments
- Never autoclave econo-grade stainless with superior-grade stainless.
- Always autoclave instruments with box lock open to alleviate pressure at the joint and to prevent fracture
- Lubricate joint and box lock after cleaning with an anti-microbial, water soluble lubricant
- Protect the tips of delicate instruments with protective covers (see page a.)
- Never use an instrument for anything other than its intended use

### Additional Safeguarding Guidelines

#### Scissors and Other Blades

- Perform routine inspections for sharpness, as a blade becomes duller with each stroke (all operating and Mayo scissors should be able to cut through four layers of gauze)
- When blades no longer cut without an excessive amount of force, please return them to Sontec® for sharpening
- The more often a blade is sharpened, the longer it tends to last

#### Needle Holders

- Repair is necessary when needle holder no longer securely holds needle when locked on the second ratchet tooth, and needle turns easily by hand

### Please Note

- We are not responsible for typographical errors in this catalog
- Instruments pictured in this catalog may or may not be to size
- Variations and changes in instrument design are possible
- Pricing is subject to change without notice
- Delivery schedules may vary from original estimates
- Some items are for veterinary use

### Contact Info

Sontec Instruments, Inc.  
7248 South Tucson Way  
Centennial, Colorado 80112, USA  
Toll free: 800.821.7496  
Local: 303.790.9411  
service@sontecinstruments.com  
www.sontecinstruments.com

## Troubleshooting Guide

Problem	Cause	Solution
Rust	Worn chrome plating on brass instruments	Be aware of plating condition and remove from service when wear is visible.
	Cross-corrosion from carbon instruments to stainless steel	Keep carbon steel and stainless steel instruments separated during cleaning and sterilization.
	Low grade instruments may not have been passivated	Remove from service.
	Autoclave not operating properly	Clean and thoroughly flush water lines in sterilizer according to manufacturer's instructions. Only use distilled water, never tap water, to generate steam.
	Organic matter left on instrument after surgery	Remove all blood and tissue before drying. Use distilled water and a nylon brush to clean hard to reach areas.
Pitting	Prolonged exposure to corrosive chemicals and/or organic substances	Only use approved cleaning and sterilization solutions. Thoroughly rinse and dry instruments.
Orange / Brown Stains	Contaminated sterilizer, high alkaline detergent, cold disinfectants	Clean sterilizer. Use neutral pH solutions. Thoroughly clean, rinse, and dry instruments.
Bluish Black Stains	Mixing dissimilar metals during cleaning and sterilization	Separate carbon steel, aluminum, and stainless steel instruments.
Rainbow - colored Stains	Chromium oxide stain-result of excessive heat	Send in for polishing and hardness check.
Cracked Box Lock	Excessive force, sterilized in the closed position	Replace the instrument.
Cracked Jaw on Pin Cutter	Cutting pin at tip of jaws	Replace the instrument. Cut pin in center of jaws.



 Sontec Instruments®

KNIFE & BLADE Handles

**Knife Handle #3**

Fits surgical blades 10-15 / with calibrated scale

\* surgical blade not included

1100-740 5" (12.5 cm)



Round handle

1100-741 6" (15 cm)

1100-740



1100-741

Round knurl handle / double / 1 mm / 6 1/4"

1100-7411



1100-7411

**Wide Barrel Grip Knife Handle #3**

Round knurled / straight / 5" (12.7 cm)

117-577



117-577

**Universal Adjustable Angle Knife Handle #3**

Adjustable tip & lock / straight / horizontal adjusting / 10 mm locking increments of 7 positions / 6 1/2" (16.5 cm)

117-578

117-5781



117-578



117-5781

**Staley Round Knurled Knife Handle**

Aluminum / 6" (15.2 cm)

1100-745



1100-745

**Sontec Knife Handle #3XXL**

16" (40.6 cm)

1100-8681



**Beaver® Blade Chuck Handle #3K**

Fits Beaver® style blades

117-560

T117-560 titanium



117-560



T117-560

**Blake Blade Holder**

Fits size blades #10, 11, 12, 12D, 15, 15C

1100-7413



1100-7413

**Siegel Knife Handle**

Fits surgical blades 10-15 / round handle

117-588



117-588

**Gubish Surgical Pen Holder Set**

5 1/4" (13 cm)

117-593



chuck

117-593



 Sontec Instruments®

Scissors

**Sontec® Scissors are simply unmatched in design, function, quality and variety. Sontec Scissors are offered in any model blade, shape or size in all of our model options listed below:**

**Classic Model**

- Combining extremely high quality with unmatched value
- Satin or high gloss finish

**Tungsten Carbide - TC inserts**

**Gold Rings**

- diamond-ground tungsten-carbide inserts
- extremely sharp
- Blade hardness greatly increases scissor life
- available with or without serrations

**Powercut blades® - PC gold**

**Gold Rings with Stripes on Shanks**

- sharpest cutting edge available
- serrated unless otherwise requested
- Finished in Sontec's Trademarked PC Gold design
- All the attributes of Sontec PC Black scissors

**Powercut blades® - PC black**

**Black Rings**

- All the attributes of Sontec PC Gold
- Beautifully ornamented in black chrome

**Tungsten Carbide / Power Cut - TC/PC:**

**Gold Ring / Black Ring**

- Serrated unless otherwise requested
- a combination of the best options
- HANDLE: one gold ring, one black ring
- This premier line encompasses TC long life, PC power, and Sontec Quality

**Ceramic Coated Scissors:**

**Black Ring**

- offered to protect your investment even further by putting the instrument into an extremely hard coating which adds more life to your Sontec Scissors
- Offered in either PC or TC/PC models



**Operating Classic, Tungsten Carbide, Power Cut Gold, Power Cut Black®, TC/PC Power Cut® Scissors**

**Blunt-blunt / straight / 5 1/2" (14 cm)**

- 1100-212 classic
- 1100-260 TC
- 1200-212 PC gold
- 1200-712 PC black



**Blunt-blunt / curved / 5 1/2" (14 cm)**

- 1100-224 classic
- 1100-262 TC
- 1200-224 PC gold
- 1200-713 PC black



**Sharp-blunt / straight / 5 1/2" (14 cm)**

- 1100-214 classic
- 1100-214L classic left
- 1100-265 TC
- 1200-214 PC gold
- 1200-229 TC/PC
- 1200-714 PC black



**Sharp-blunt / curved / 5 1/2" (14 cm)**

- 1100-226 classic
- 1100-264 TC
- 1200-226 PC gold
- 1200-715 PC black





**Operating Classic, Tungsten Carbide, Power Cut Gold, Power Cut Black®, TC/PC Power Cut® Scissors**

**Sharp-sharp / straight / 5 1/2" (14 cm)**

- 1100-216 classic
- 1100-268 TC
- 1200-216 PC gold
- 1200-231 TC/PC
- 1200-716 PC black



blunt-blunt

sharp-blunt

**Sharp-sharp / curved / 5 1/2" (14 cm)**

- 1100-228 classic
- 1100-270 TC
- 1200-228 PC gold
- 1200-717 PC black



1100-268



1200-716

**Reynolds Tenotomy Classic, Power Cut Gold, Power Cut Black®, TC/PC Power Cut® Scissors**

**Classic / 5 3/4" (14.5 cm)**

- 2405-324S straight
- 2405-324 curved



2405-324S

**PC gold / 5 3/4" (14.5 cm)**

- 2400-324S straight
- 2400-324 curved

**PC black / 5 1/4" (13.3 cm)**

- 2400-823S straight
- 2400-823 curved

**PC black / 5 3/4" (14.5 cm)**

- 2400-824S straight
- 2400-824 curved

**TC/PC / 5 3/4" (14.5 cm)**

- 2405-824S straight
- 2405-824 curved

**Classic / 6 1/4" (16 cm)**

- 2405-326 straight
- 2405-327 curved



2400-327

**PC gold / 6 1/4" (16 cm)**

- 2400-326 straight
- 2400-327 curved
- 1200-348 curved spread handle

**PC black / 6 1/4" (16 cm)**

- 2400-826 straight
- 2400-827 curved
- 2400-827S curved spread handle

**TC/PC / spread handle / 6 1/4" (16 cm)**

- 2405-826 straight
- 2405-827 curved



2400-827S

**Freeman-Kaye Ergonomic Spread Handle Saberback Scissors**

Ergonomic / spread handle / double beveled blades / spatulated tip / curved / TC/PC

475-188 7 1/4" (18.5 cm)  
475-187 9" (23 cm)

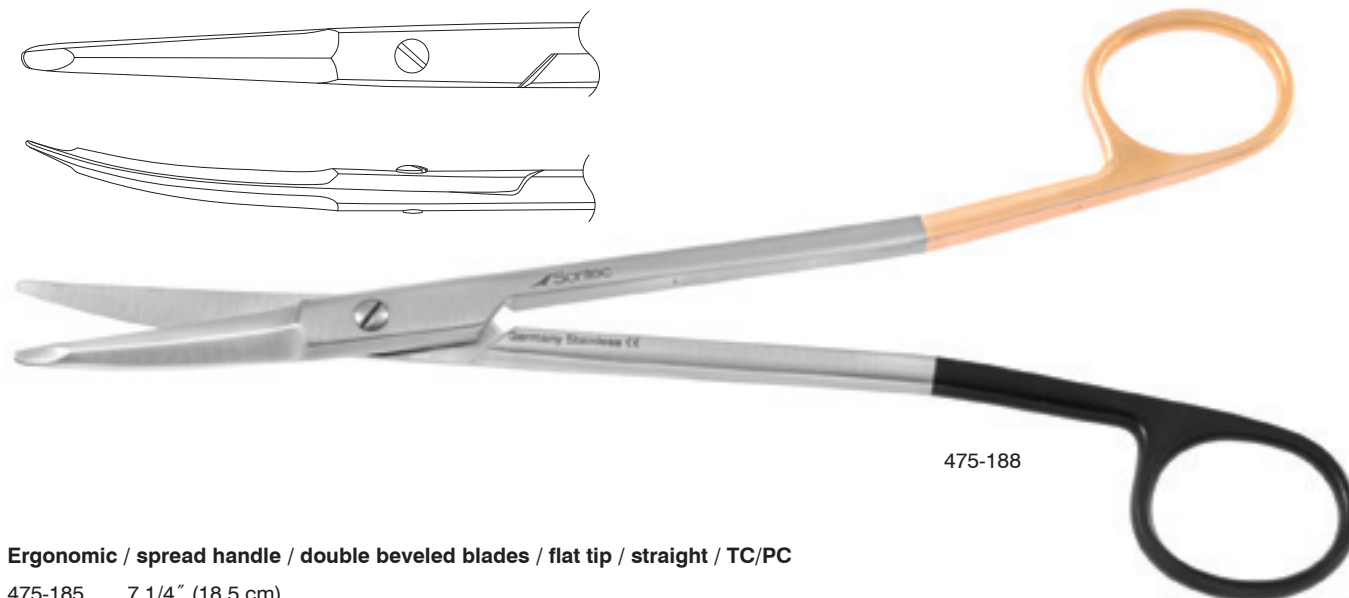

Ergonomic / spread handle / double beveled blades / flat tip / straight / TC/PC

475-185 7 1/4" (18.5 cm)  
475-186 9" (23 cm)



**Freeman-Kaye Ergonomic Spread Handle Saberback Scissors**

Ergonomic / spread handle / double beveled blades / flat tip / curved / PC black / delicate

475-182 7 3/4" (20 cm) fino  
475-184 9" (23 cm)

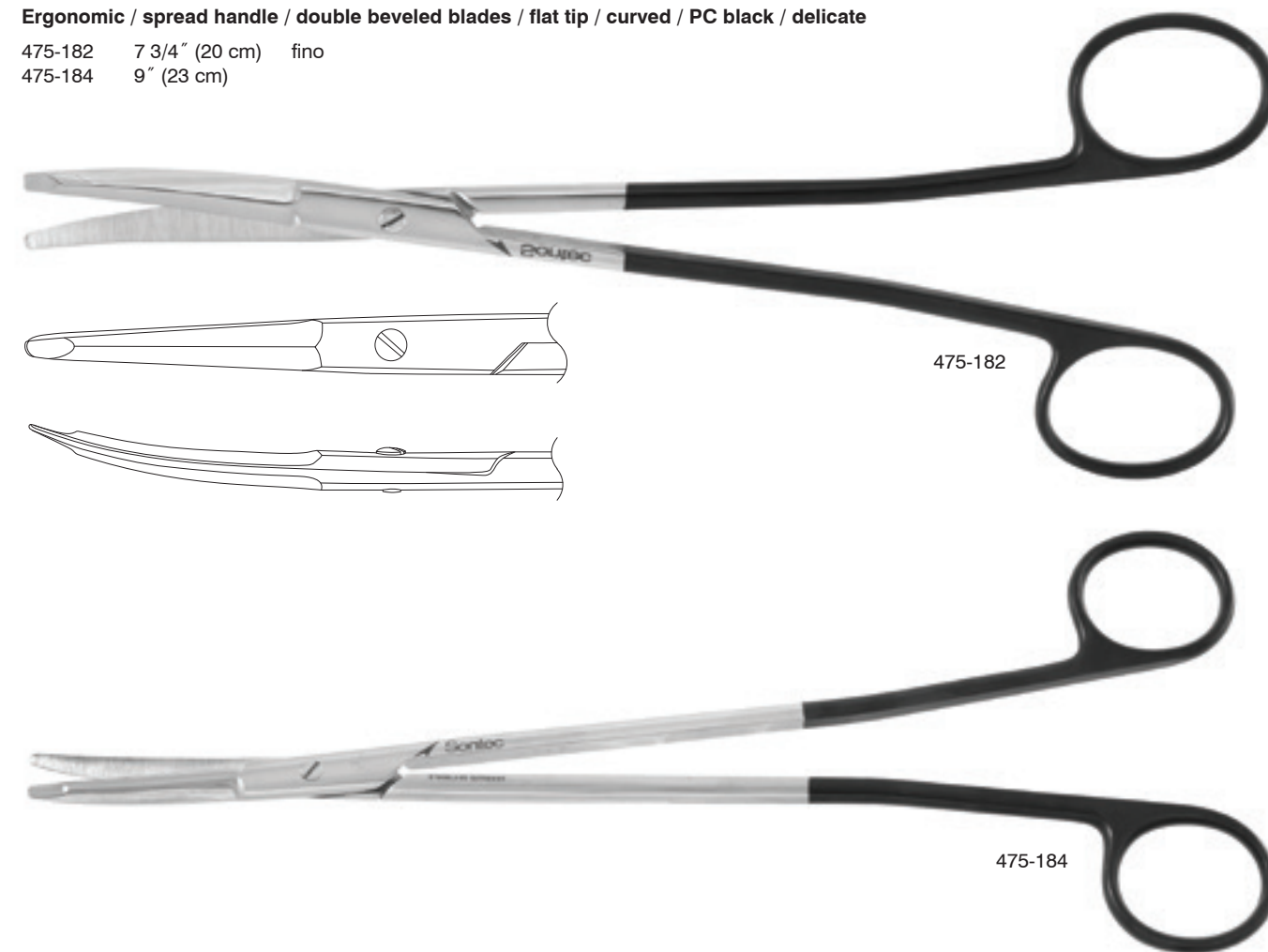

**Freeman-Kaye Ceramitec Ergonomic Spread Handle Saberback Scissors**

Ergonomic / spread handle / double beveled blades / spatulated tip / curved / TC/PC / black ceramic / gold handles

475-188B 7" (17.8 cm)



**Wilkinson Rhytidectomy Scissors**

TC/PC / curved / angled shaft / 7 1/2" (19 cm)  
475-250



475-250

**Black Kaye Scissors**

Saberback / PC black / curved / 5 3/4" (14.5 cm)  
1200-851



1200-851

**Kahn-Fomon Scissors**

Saberback / PC gold / spread handle / curved / 5 1/2" (14 cm)  
1200-392



1200-392

**Gorney-Kahn Scissors**

Saberback spatulated tips / TC / 5 3/4" (14.5 cm)

475-203 straight  
475-204 curved

TC / 8" (20 cm)

475-207 straight  
475-208 curved



475-204

**Aufricht Saberback Power Cut Black® Scissors**

PC black / 5 3/4" (14.6 cm)

1200-848 straight  
1200-849 curved

PC gold / 6 3/4" (17 cm)

475-220 straight  
475-225 curved



1200-848

**Kahn Face-Lift Scissors**

**Saberback / PC gold / 5 3/4" (14.5 cm)**

- 475-174 straight
- 475-175 curved



475-174

**PC black / 5 3/4" (14.5 cm)**

- 1200-830 straight
- 1200-831 curved



curved

**PC gold / 7" (18 cm)**

- 475-190 straight
- 475-191 curved

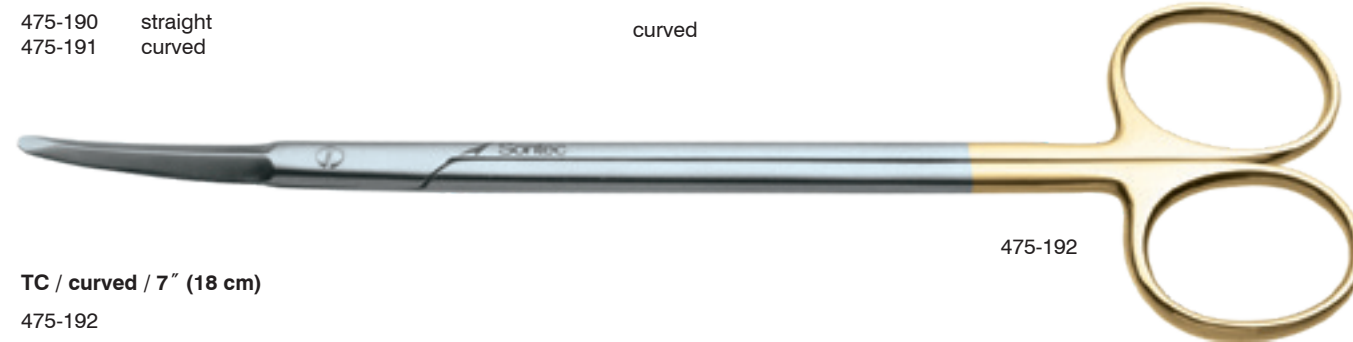

475-192

**TC / curved / 7" (18 cm)**

- 475-192

**TC/PC / 7" (18 cm)**

- 475-194 straight
- 475-195 curved

**PC two-tone silver / 7 1/2" (19 cm)**

- 475-196 straight
- 475-197 curved

**Trepsat Face-Lift Scissors**

**Black ceramitec / 6 3/4" (17 cm)**

- 1200-925 PC straight



**Plastic Surgery Scissors**

**Sharp/sharp / classic / 4 3/4" (12 cm)**

- 2400-045 straight
- 2400-047 curved

**Sharp/sharp / PC gold / 4 3/4" (12 cm)**

- 2400-053 straight
- 2400-055 curved

**Blunt/blunt / classic / 4 3/4" (12 cm)**

- 2400-049 straight
- 2400-051 curved

**Blunt/blunt / PC gold / 4 3/4" (12 cm)**

- 2400-057 straight
- 2400-059 curved

**Sharp/blunt / classic / 4 3/4" (12 cm)**

- 2400-043 straight
- 2400-044 curved

**Sharp/blunt / PC gold / 4 3/4" (12 cm)**

- 2400-061 straight
- 2400-063 curved



2400-053



sharp-sharp



blunt-blunt



sharp-blunt

**Littler Suture Carrying Scissors**

Fenestrated blade tips / curved / 4 3/4" (12 cm)  
475-164



**Giunta Tungsten Carbide Serrated Scissors**

TC / Angled up / bayonet  
475-148 straight blades 4 1/4" (11 cm)  
475-150 5" (12.5 cm)



**Biro Naevus Scissors**

Angled-up / sharp / 4" (10 cm)  
199-500  
199-501 PC gold  
199-501B PC Black

Angled-up / sharp / spread  
handle / 4" (10 cm)  
199-502 PC gold



**Swedish Gradle Scissors**

PC gold / ergonomic spread handle / sharp / 3 3/4" (9 cm)

199-550



199-550

**Chadwick Scissors**

PC gold / sharp / curved / 4 3/4" (12 cm)

1200-407



1200-407

open

side view

**Taylor Dura Scissors**

Beaded tip / PC Gold / 5 1/2" (14 cm)

\*Can also be used as a bandage scissors

1200-195



1200-195

**Jabaley Scissors**

PC black / 4 3/4" (11 cm)

2400-753 straight

2400-755 curved

Ergonomic spread handle / PC black / 5" (12.7 cm)

2400-756 curved

2400-757 straight

Black ceramic with gold screw / ergonomic spread handle / PC / 5" (12.7 cm)

1200-940 curved



2400-756



1200-940

**Par Scissors**

TC / 4 1/2" (11.5 cm)

112-580 straight

112-585 curved

TC / 5 3/4" (14.5 cm)

112-581 straight

112-582 curved

PC gold / curved / 5 3/4" (14.5 cm)

1200-402



1200-402

**Cooley Power Cut Gold® Scissors**

PC gold / 7 1/2" (19 cm)

- 2400-396 straight
- 2400-397 curved



2400-397

**Joseph Sharp Sharp Classic Power Cut Gold® Power Cut Black® Scissors**

PC Black / 5 1/2" (14 cm)

- 2400-728 straight
- 2400-729 curved



2400-728

PC Gold / 5 1/2" (14 cm)

- 2400-428 straight
- 2400-435 curved

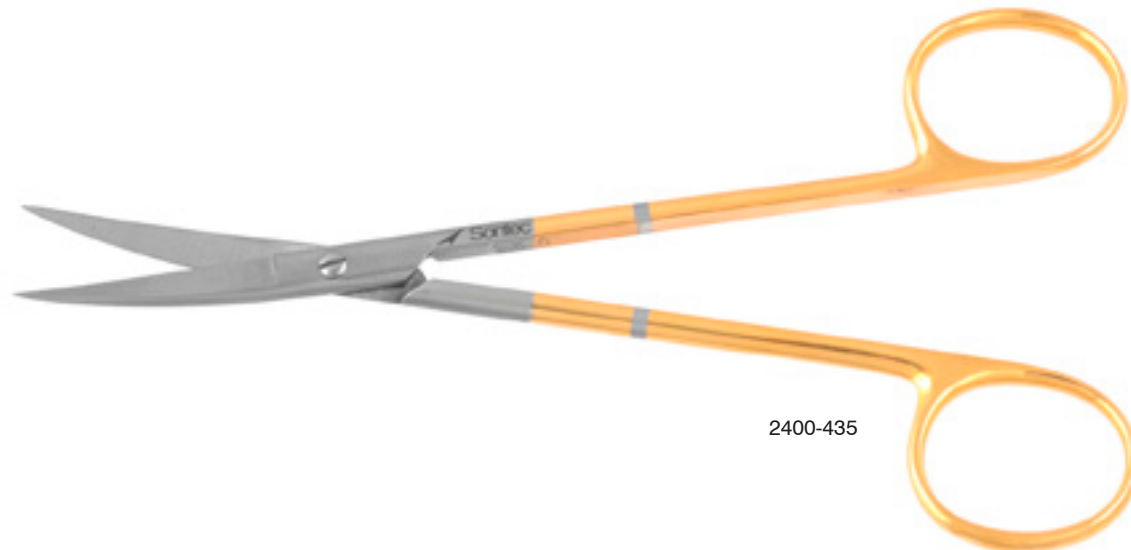

2400-435

5 3/4" (14.5 cm)

- 110-312 straight
- 110-313 curved

**Joseph-Peck Saberback Classic Power Cut Gold® Power Cut Black® TC/PC Power Cut Scissors**

Saberback / curved / 4 1/2" (15 cm)

- 2400-438 PC Gold

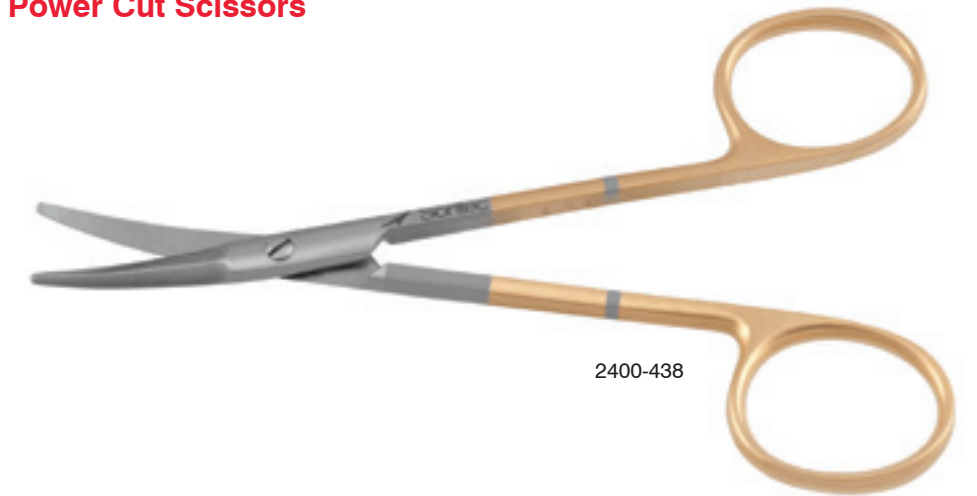

2400-438

Saberback / curved / 6" (15 cm)

- 2400-440 classic
- 2400-439 PC Gold
- 2400-442 TC/PC
- 2400-739 PC Black curved
- 2400-733 PC Black straight

Straight / 6" (15 cm)

- 2400-433 PC Gold

Ceramic coated / saberback / TC/PC curved blades / black with gold screw and gold shiny rings / 6" (15 cm)

- 1200-945



2400-442



1200-945

**Kelly Power Cut Gold® Power Cut Black® Fistula Scissors**

**PC Black / 6 1/4" (16 cm)**

- 508-636 straight
- 508-637 curved



508-637

**PC Gold / 6 1/4" (16 cm)**

- 508-638 straight
- 508-639 curved



508-639

**Classic / 6 1/4" (16 cm)**

- 508-632 straight
- 508-633 curved



508-632

**Classic / serrated / 6 1/4" (16 cm)**

- 508-634 straight
- 508-635 curved

**Ragnell Undermining Power Cut Gold® Scissors**

**PC gold / spatulated tips / curved**

- 2400-374 4 1/2" (11.5 cm)
- 2400-375 5" (12.5 cm)
- 2400-376 5 1/2" (14 cm)
- 2400-377 6" (15 cm)
- 2400-379 7" (18 cm)
- 2400-381 8" (20 cm)
- 2400-383 9" (23 cm)
- 2400-383S 9" (23 cm) strong curved
- 2400-385 10 3/4" (26.5 cm)



strong curved  
2400-383S



2400-374



2400-375



2400-377



**Kaye Blepharoplasty Scissors**

Curved / spread handle / 4 3/4" (12 cm)

- 1200-076 PC Gold
- 1200-076B PC Black



**Brown Scissors**

PC gold / 5 3/4" (14.5 cm)

- 475-168 straight
- 475-170 curved



PC Black / 5 3/4" (14.5 cm)

- 475-168B straight
- 475-170B curved



**Kaye Blepharoplasty Scissors**

TC / 4 1/2" (11.5 cm)

- 112-602 straight
- 112-603 curved

Serrated / ribbon handle / 4 1/4" (10.8 cm)

- 1200-070 PC gold straight
- 1200-072 PC gold curved
- 13-6800 PC silver straight
- 13-6810 PC silver curved
- 13-6815 PC Black curved

Curved / spread handle / 4 3/4" (12 cm)

- 1200-076 PC Gold
- 1200-076B PC Black

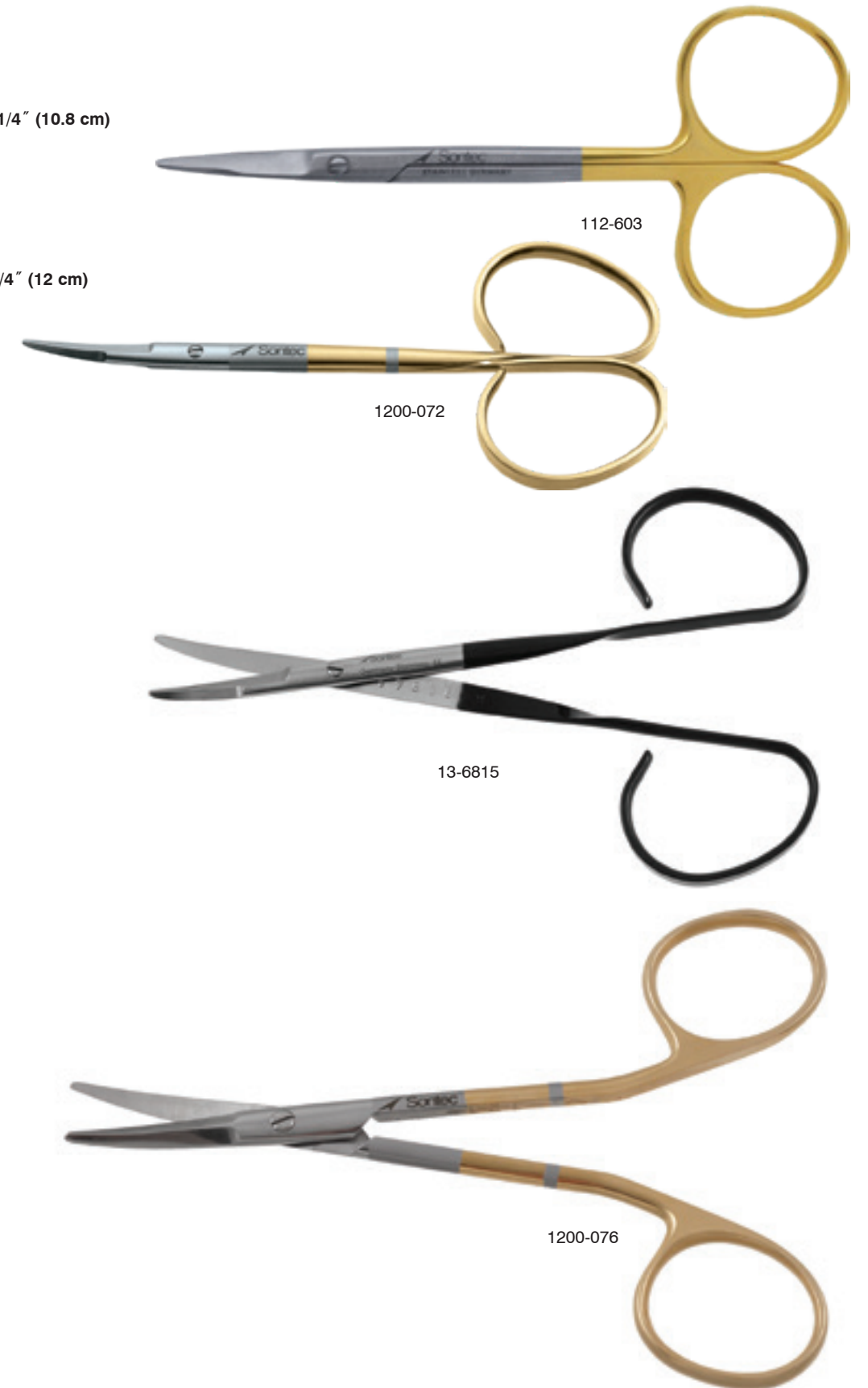

**Fomon Saberback Scissors**

Semi-sharp outer edges / curved / 5 1/2" (14 cm)

- 475-140 classic
- 1200-400 PC Gold
- 1200-401 PC Black



1200-400

Semi-sharp outer edges / PC gold / curved / 4 3/4" (12 cm)

1200-399



1200-399



1200-401

**Sistrunk Scissors**

Curved / 5 1/2" (14 cm)

110-260

PC gold / curved

- 1200-410 5 1/2" (14 cm)
- 1200-411 6" (15 cm)



1200-411

PC black / straight / 6" (15 cm)

1200-840

**Castanares Scissors**

PC Gold / 6 3/4" (17.1 cm)

1200-445 straight



1200-445

**Castanares Scissors**

**Classic / 6" (15.2 cm)**

110-308

**PC Black / 6" (15.2 cm)**

1200-845 straight

1200-846 curved



110-308



1200-845

**Famous Saberback Scissors**

**PC gold / tenotomy tip / 6 1/2" (16.5 cm)**

1200-386 straight

1200-387 curved

**PC black / tenotomy tip / 6 1/2" (16.5 cm)**

1200-386B straight

1200-387B curved

**PC gold / tenotomy tip / 8" (20.5 cm)**

1200-388 straight

1200-389 curved



1200-387



1200-387B

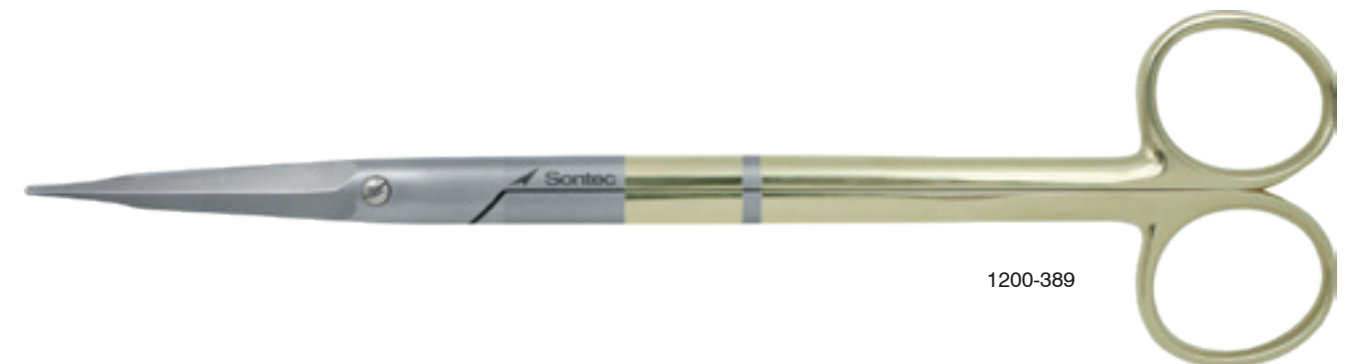

1200-389

**Sontec® Bipolar Metzenbaum Scissors**

For dissecting, cutting, and bipolar coagulation of tissue / one prong / classic blades

- 2700-5331 7"
- 2700-5341 8"
- 2700-5351 9"
- 2700-5371 11"



For dissecting, cutting, and bipolar coagulation of tissue / one prong / delicate blades

- 2700-5411 7"
- 2700-5431 8"
- 2700-5451 9"
- 2700-5471 11"

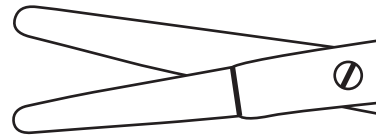

One prong cord / sold separately

- 2700-5251 3 meter cord
- 2700-5271 5 meter cord



130-141-300

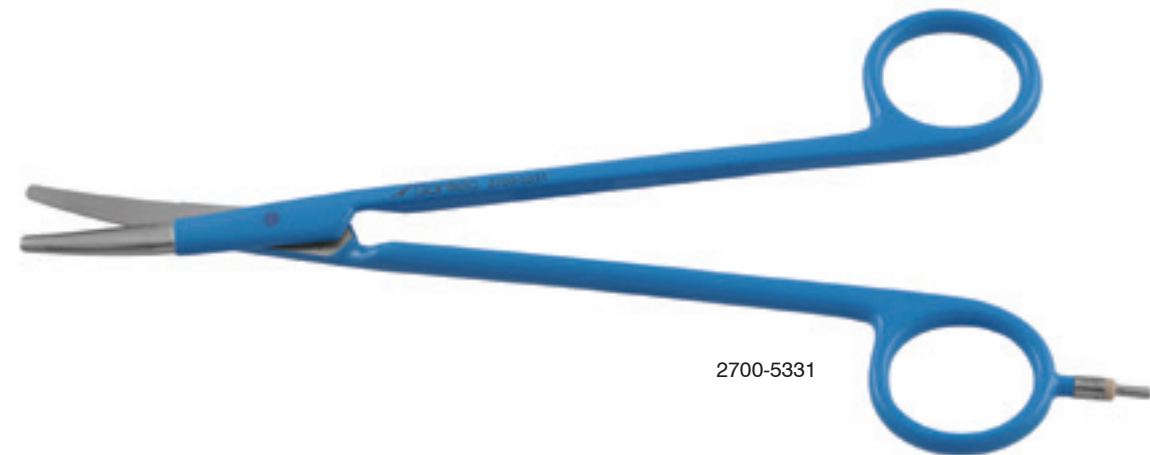

2700-5331

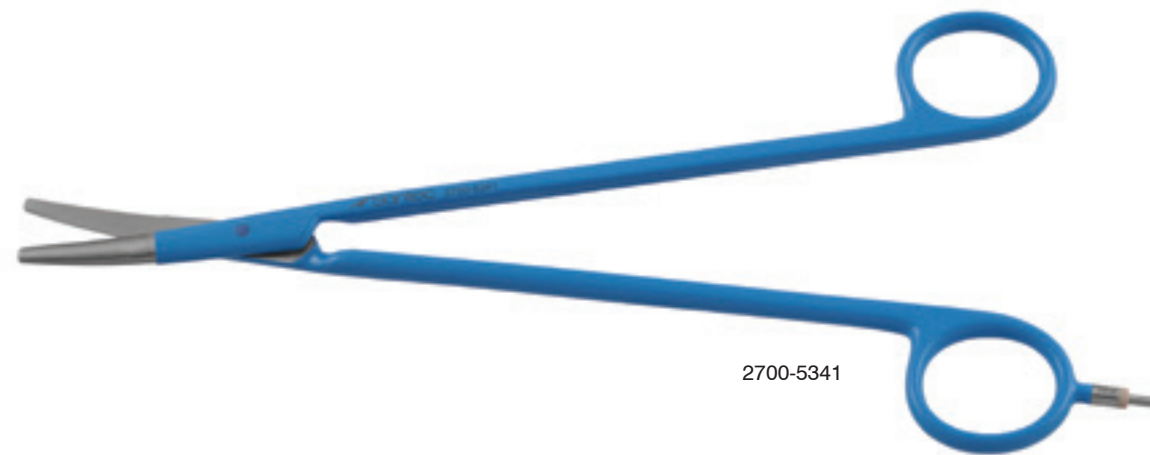

2700-5341

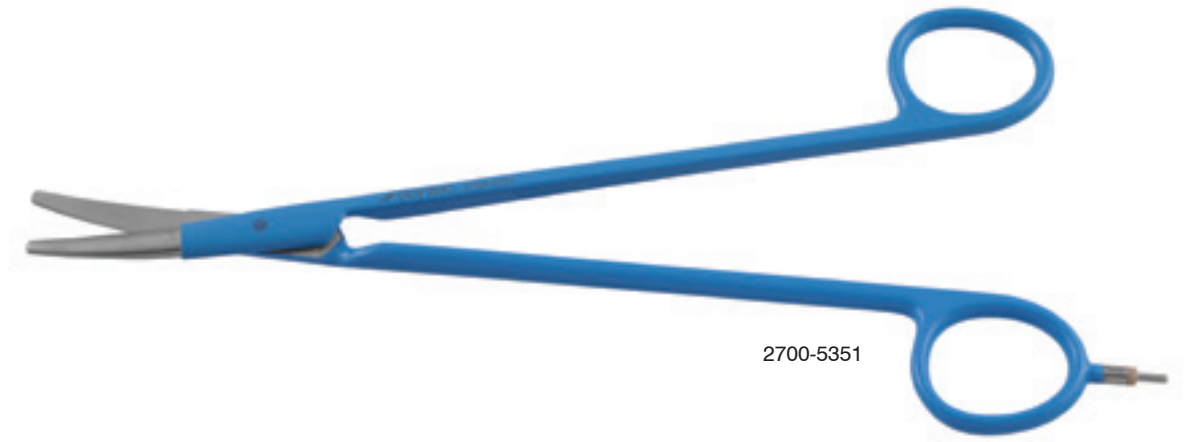

2700-5351

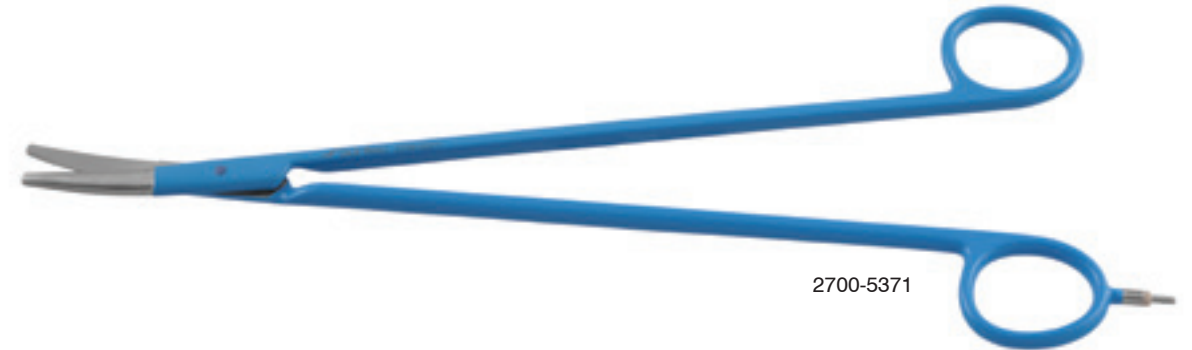

2700-5371

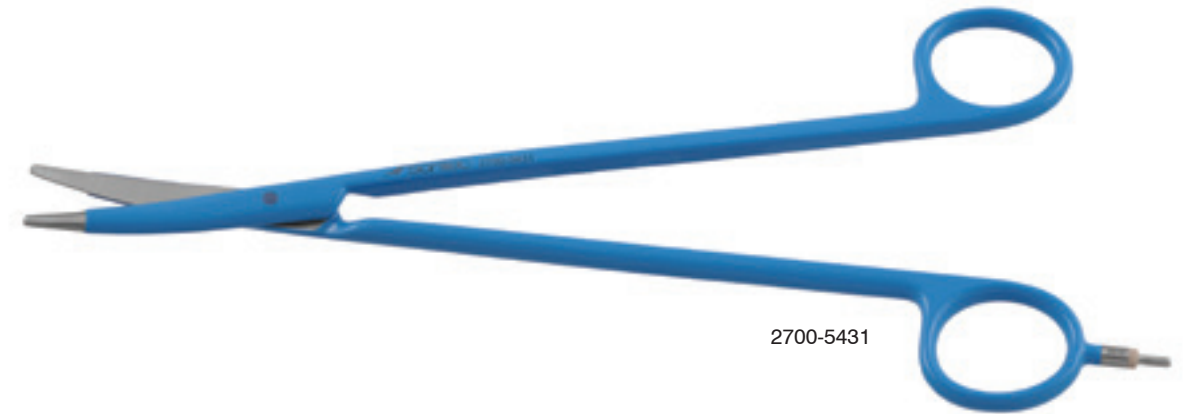

2700-5431

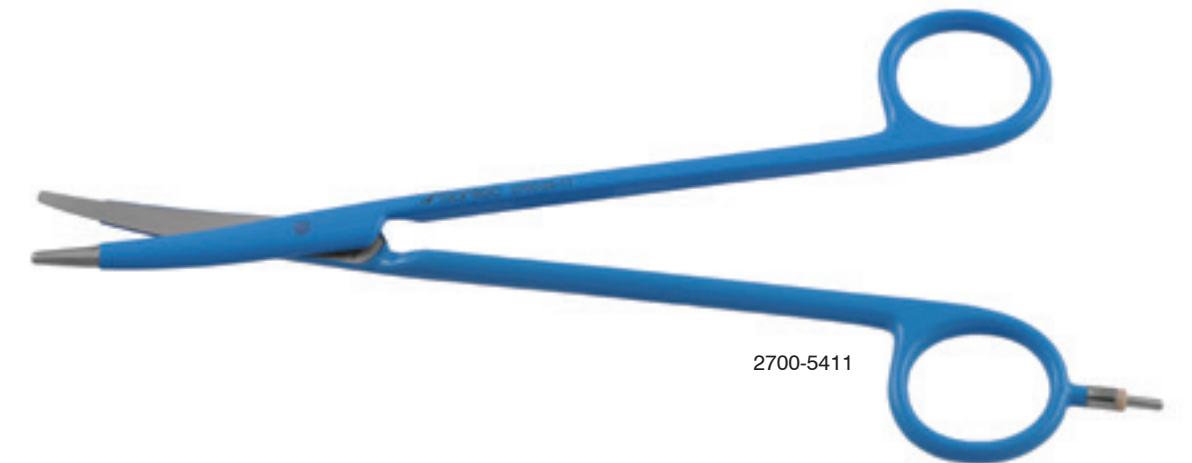

2700-5411

**Heymann Nasal Scissors**

PC gold / heavy / 7" (18 cm)  
475-302



475-302

**Knight Nasal Scissors**

Serrated / 7" (18 cm)  
475-300 classic  
475-304 PC black



475-304

**Knight Nasal Scissors**

Serrated / PC gold / 7" (18 cm)  
475-306 Right curved  
475-307 Left curved



475-306

**Gorney Turbinate Scissors**

PC gold / angled / 6 3/4" (17 cm)  
1200-420



1200-420

**Cottle-Dorsal Scissors**

TC / 6 1/2" (16.5 cm)  
475-295



475-295

PC black / serrated / 6 1/2" (16.5 cm)  
1200-808



1200-805

PC black / serrated  
1200-805 6 1/4" (15.9 cm)  
1200-810 6 1/4" (15.9 cm) heavy



1200-810

PC gold / serrated / heavy / 6 3/4" (17 cm)  
1200-310

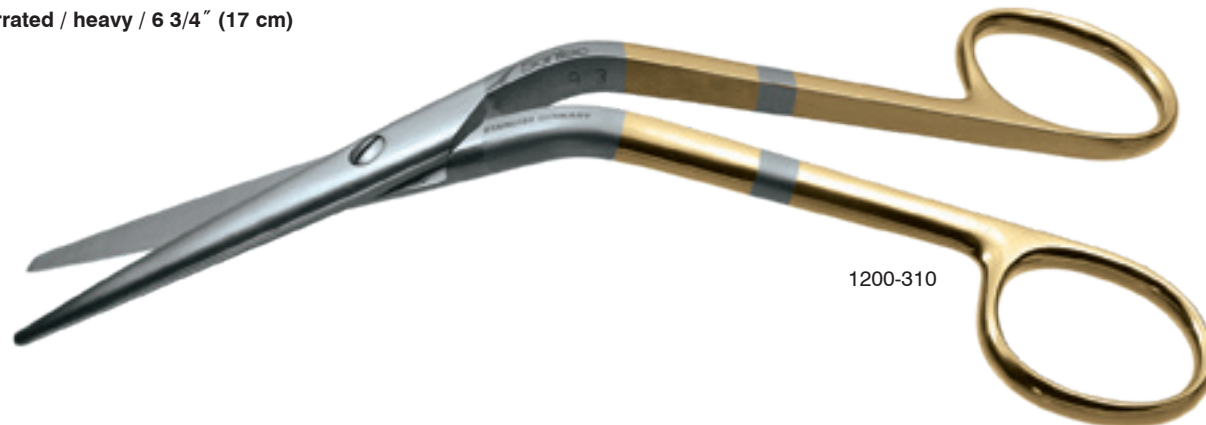

1200-310

**Cottle-Dorsal Scissors**

PC black / rounded Stille blades /  
serrated / blunt / 5 1/2" (14 cm)  
1200-806



1200-806

**Foman-Dorsal Scissors**

PC gold / serrated / 5 3/4" (14 cm)  
1200-300 beveled blades

PC black / serrated / 5 1/2" (14 cm)  
1200-800 beveled blades

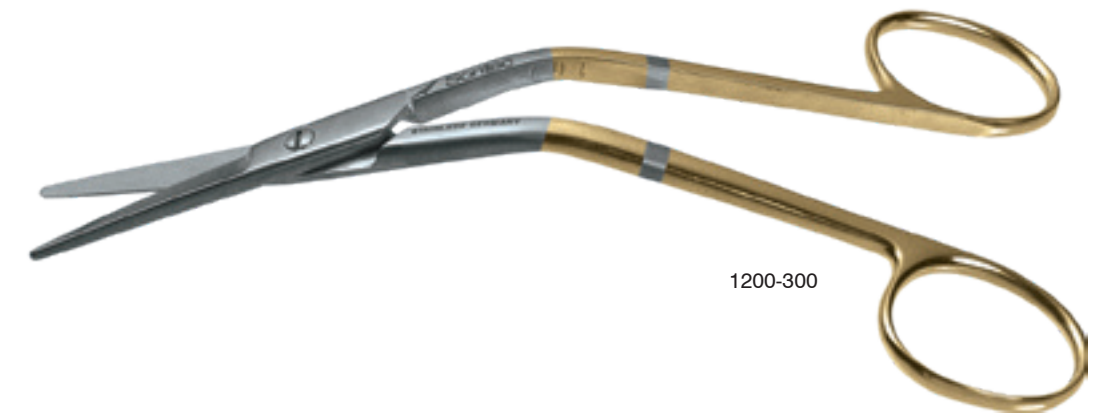

1200-300

**Foman-Dorsal Scissors**

PC black / 5 3/4" (14.6 cm)  
1200-812



**Heymann Nasal Scissors**

PC black / light / 7" (18 cm)  
475-301



**Gorney Septal Scissors**

Serrated blades / 7 3/4" (19.5 cm)  
475-310

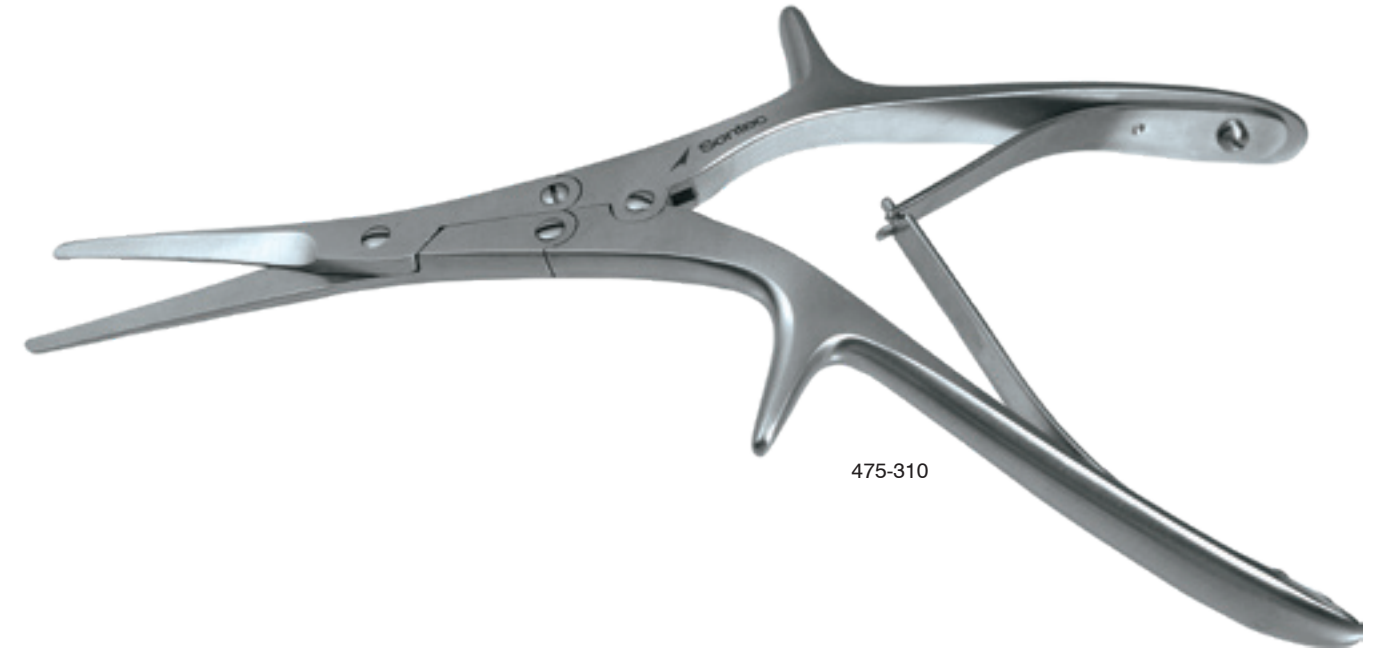

**Becker Septum Scissors**

Serrated blades / double action / 7" (18 cm)  
475-320

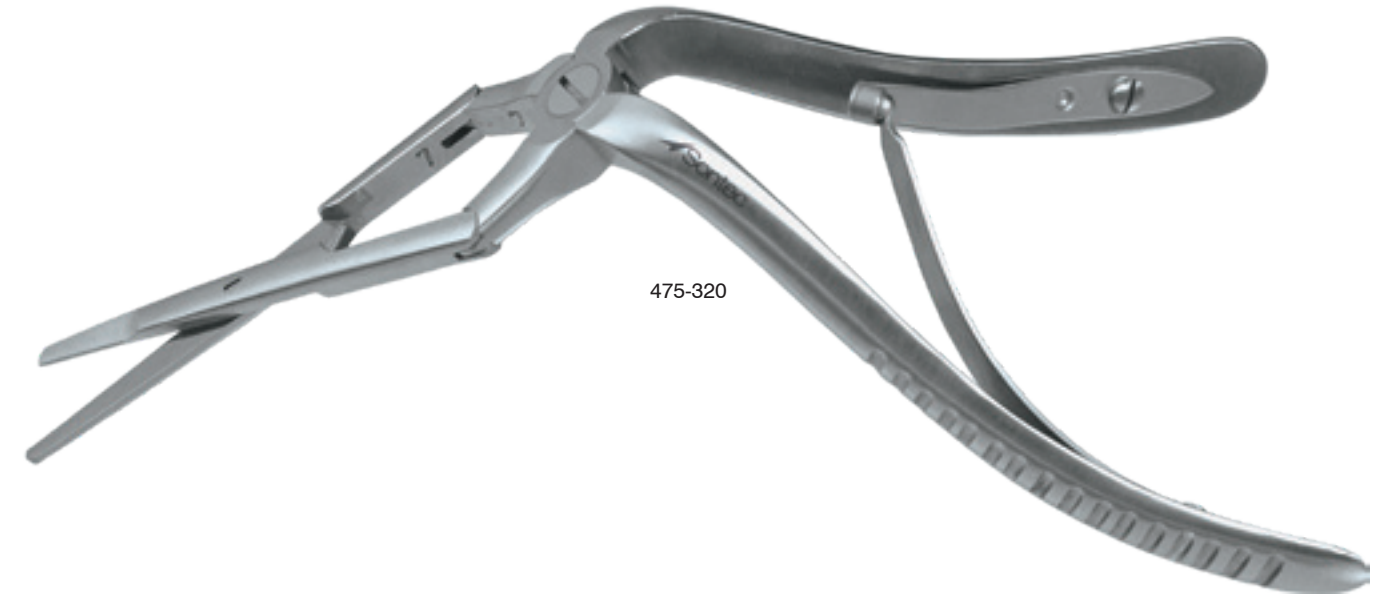

**Caplan Nasal Bone Scissors**

Serrated blades / 8 3/4" (22 cm)  
475-325



**Nasal Scissors**

13 mm blunt blades / 6 1/4" (16 cm) shaft  
468-104



**Nasal Scissors**

Serrated / 5" working length  
468-090 straight  
468-092 left  
468-094 right



**Sontec Nasal Scissors**

Double-action / angled to side / 8" (20 cm)  
475-330





**Jacobson Micro Scissors**

Round handle / sharp blades / 14 mm / 4 1/4" (10.75 cm)

- 2400-626 25°
- 2400-627 45°
- 2400-629 60°
- 2400-631 90°
- 2400-633 125° g-neck



14 mm tip

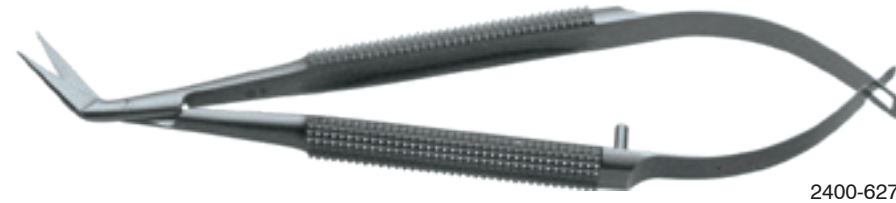

2400-627

Round handle / sharp blades / 11 mm / 4 1/4" (10.75 cm)

- 2400-6261 25°
- 2400-6271 45°
- 2400-6291 60°
- 2400-6311 90°
- 2400-6331 125°



11 mm tip



2400-6261

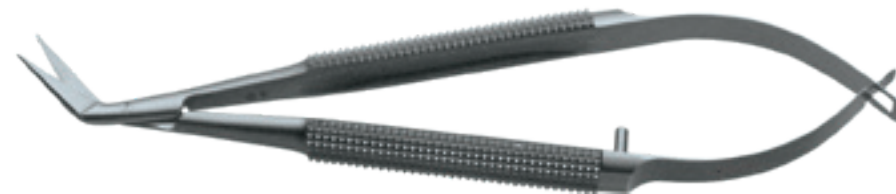

2400-629

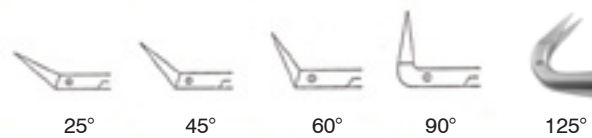

25°

45°

60°

90°

125°

**Double Action Micro Scissors**

Titanium/ stainless / round handle / 7 1/4" (18.5 cm)

- 2600-914 straight
- 2600-916 curved



2600-916

**Sontec Double Action Micro Scissors**

Double action / round handle / 7 1/4" (18.5 cm)

- 2400-545 straight
- 2400-547 curved



2400-545

**Sontec Heifetz Micro Scissors**

Double action / round handle / 6" (15 cm)

- 2400-542 straight
- 2400-544 curved

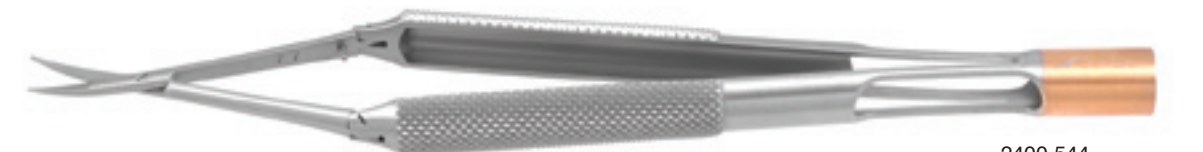

2400-544

**Mayo-Carroll Scissors**

Extra heavy design / TC / 9" (23 cm)

- 1100-276 straight
- 1100-282 curved



1100-282

**Mayo-Harrington Scissors**

Classic beveled blades / straight / 8" (20 cm)

- 2400-214 TC
- 2400-208 PC gold
- 2400-920 PC black

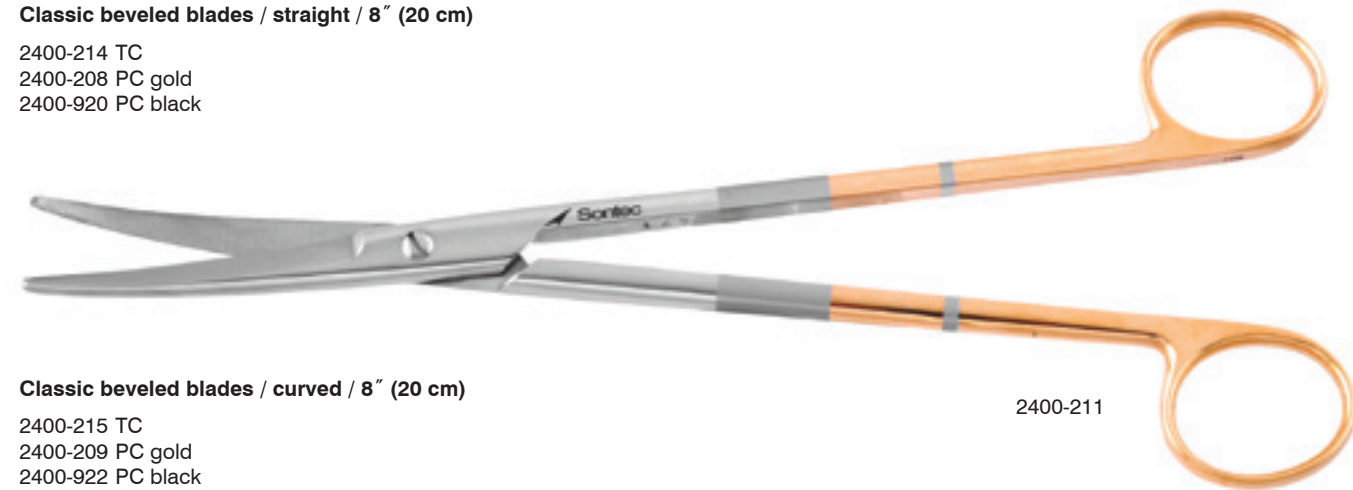

2400-211

Classic beveled blades / curved / 8" (20 cm)

- 2400-215 TC
- 2400-209 PC gold
- 2400-922 PC black

Classic beveled blades / straight / 9" (23 cm)

- 2400-216 TC
- 2400-210 PC gold
- 2400-924 PC black

Classic beveled blades / curved / 9" (23 cm)

- 2400-217 TC
- 2400-211 PC gold
- 2400-926 PC black

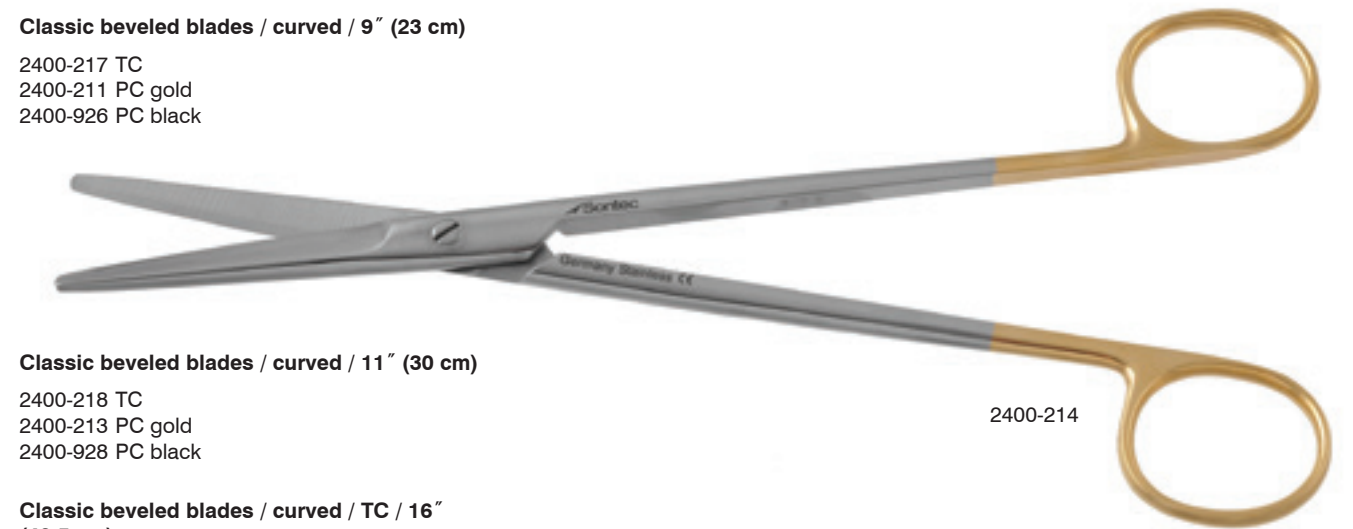

2400-214

Classic beveled blades / curved / 11" (30 cm)

- 2400-218 TC
- 2400-213 PC gold
- 2400-928 PC black

Classic beveled blades / curved / TC / 16" (40.5 cm)

- 2400-212

**Westcott Wide Handle Tenotomy Scissors**

Wide handle / curved / classic blades / 5 1/2" (14 cm)

- 13-3307 sharp
- 13-3306 blunt



13-3306



13-3307

**Westcott Tenotomy Scissors**

Blunt / 4 1/2" (11.5 cm)

- 13-3400 curved
- 13-3401 straight

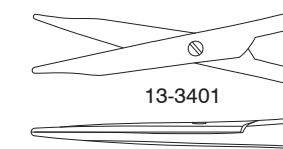

13-3401

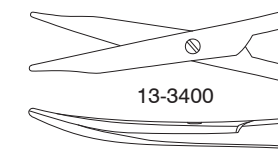

13-3400



13-3400

**Westcott Stitch Scissors**

Sharp tips / classic blades / 4 1/2" (11.5 cm)

- 13-4400 curved
- 13-4402 straight



13-4400



13-4402

MICRO SERRATIONS ON ANY SCISSOR WITH REASONABLE SIZE, PLEASE INQUIRE

**Titanium Westcott Tenotomy Scissors**

Blunt tip / fenestrated handle / 4 1/2" (11.5 cm)

- T13-3417 curved
- T13-3418 straight



T13-3417

**Stevens Tenotomy Classic PC Gold Scissors**

Pointed sharp tips / short blades / classic / 4 1/8" (10.5 cm)

- 13-8805 straight
- 13-8815 curved

Pointed sharp tips / long blades / classic / 4 1/2" (11.5 cm)

- 13-8820 straight
- 13-8825 curved



13-8825

Pointed sharp tips / long blades / PC Gold / 4 1/2" (11.5 cm)

- 13-8865 straight
- 13-8866 curved

**Stevens Tenotomy Ergonomic Spread Handle Power Cut Black® Scissors**

Blunt / long tip / PC black / ergonomic spread handle / curved / 4 1/2" (11.5 cm)

1200-708

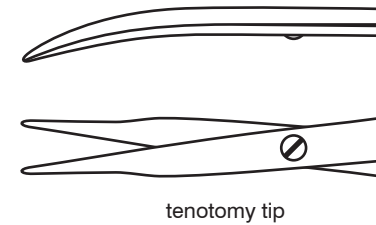

tenotomy tip

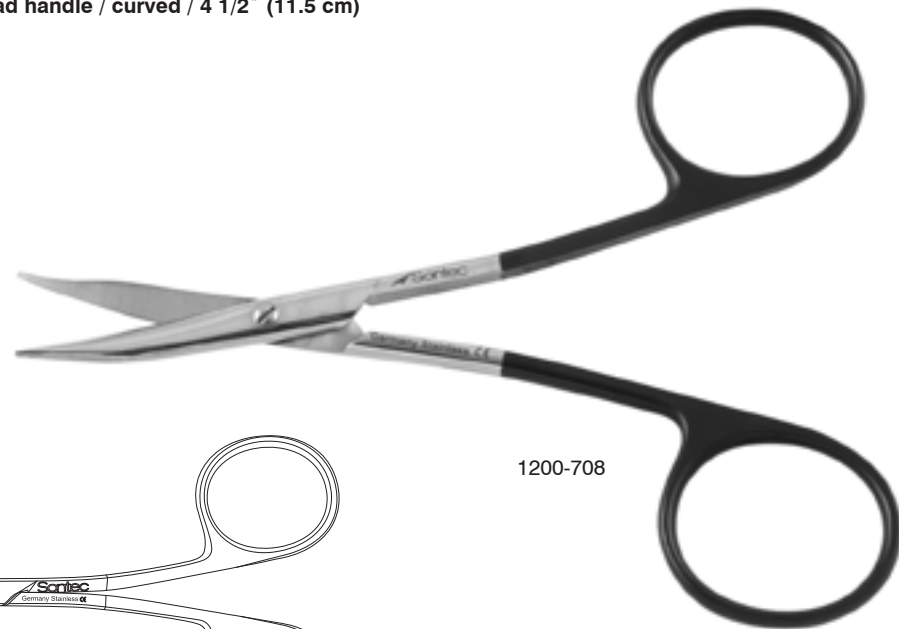

1200-708

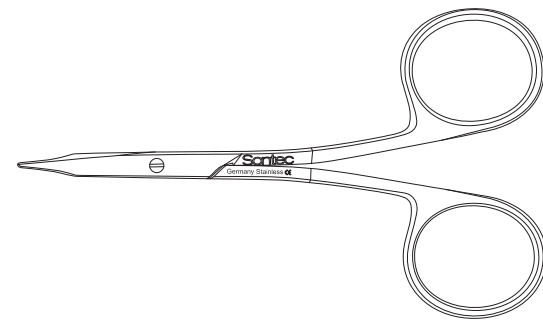

**Stevens Tenotomy Ergonomic Spread Handle Tungsten Carbide Power Cut Black/Gold® Scissors**

Blunt / long tip / tungsten carbide / PC black/gold / ergonomic spread handle / curved / 4 1/2" (11.5 cm)

1200-497

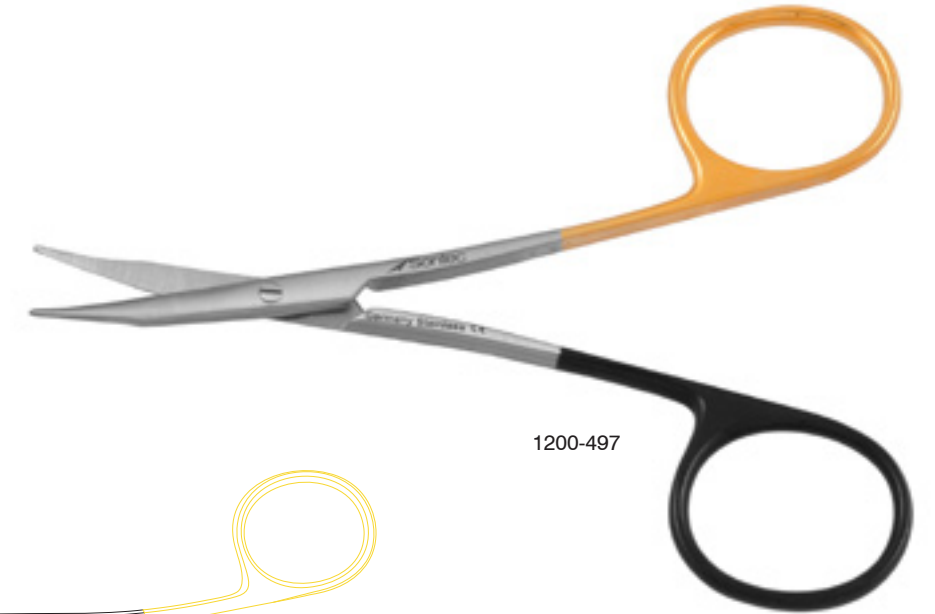

1200-497

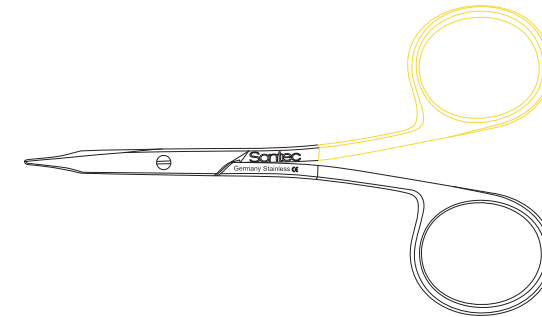

**Stevens Tenotomy , Tungsten Carbide, Power Cut Gold, Power Cut Black®, Ceramic Coated Scissors**

Blunt / long blades / with TC/PC curved blades / ceramitec / with gold screw and gold shiny rings / spread handle / 4 1/2" (11 cm)

1200-937



1200-937

**Ceramitec Stevens Tenotomy Ergonomic Spread Handle Power Cut Black® Scissors**

Black with gold screw / blunt / long tip / PC Black / ergonomic spread handle / curved / 4 1/2" (11.5 cm)

1200-935



1200-935

**Stevens Siegert Tenotomy Scissors Double Beveled Blades**

Saberback / black ceramitec coated / with gold screw / blunt long blades / curved / 4 1/2" (11.5 cm)

1200-985 black ceramitec  
1200-986

Double beveled blades / TCPC / 4 1/2" (11.5 cm)

2400-365 straight  
2400-367 curved pointed tips



1200-985

1200-986

2400-367

**Stevens Tenotomy Classic, Tungsten Carbide, Power Cut Gold, Power Cut Black®, Ceramitec Scissors**

**Blunt / long blades / straight / 4 1/2" (11.5 cm)**

- 13-8813 classic
- 1200-062 PC gold
- 1200-704 PC black
- 1200-490 TC/PC



**Blunt / long blades / curved / 4 1/2" (11.5 cm)**

- 13-8814 classic
- 1200-064 PC gold
- 1200-706 PC black
- 1200-491 TC/PC
- 1200-499 TCPC



**Blunt / long blades / curved / ceramitec / with gold screw / 4 1/2" (11.5 cm)**

- 1200-930 PC

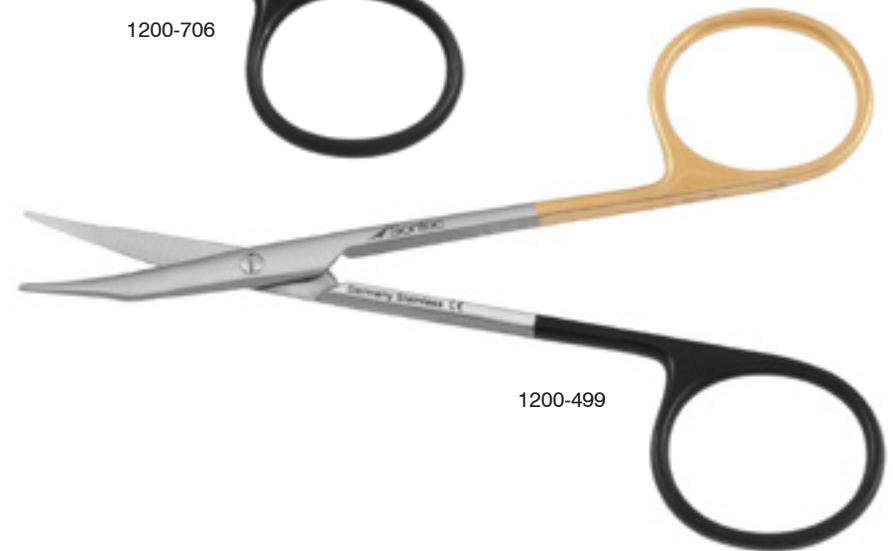

**Stevens Tenotomy Classic, Tungsten Carbide, Power Cut Gold, Power Cut Black®, Ceramitec Scissors**

**Pointed sharp blades / long blades / 4 1/2" (11.5 cm)**

- 1200-490 TC/PC straight

**Pointed sharp blades / long blades / curved / 4 1/2" (11.5 cm)**

- 1200-491 TC/PC curved



MICRO SERRATIONS ON ANY SCISSOR WITH REASONABLE SIZE, PLEASE INQUIRE

**Strabismus Classic Tungsten Carbide Power Cut Gold® Power Cut Black® Scissors**

**Delicate / PC gold / 4 1/4" (11 cm)**

- 1200-021 straight
- 1200-023 curved

**Classic / 4 1/2" (11.5 cm)**

- 1100-344 straight
- 1100-346 curved

**PC gold / 4 1/2" (11.5 cm)**

- 1200-020 straight
- 1200-022 curved

**PC black / 4 1/2" (11.5 cm)**

- 1200-775 straight
- 1200-776 curved

**PC black / sharp/sharp tips / curved / 4 1/2" (11.5 cm)**

- 1200-776S

**TC / 4 1/2" (11.5 cm)**

- 2400-360 straight
- 2400-362 curved



**Ribbon-Handle Classic Iris Scissors**

**Classic blades / 4" (10 cm)**

- 13-7600 straight
- 13-7610 curved

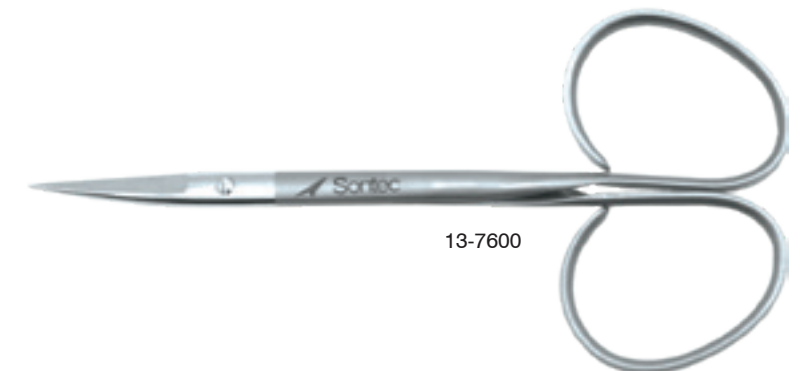

**Iris Classic Tungsten Carbide Power Cut Gold®  
Power Cut Black® TC/PC Scissors**

**Delicate / mini model / 3 1/2" (9 cm)**

- 13-7500 straight
- 13-7510 curved

**Ribbon handle / mini pattern / classic / 14 mm blades / 3 3/4" (9.5 cm)**

- 13-7720 straight
- 13-7730 curved

**PC gold / sharp tips / 4" (10 cm)**

- 2400-010 straight
- 2400-012 curved

**PC gold / blunt / 4" (10 cm)**

- 2400-015 straight
- 2400-017 curved

**PC black / sharp tips / 4" (10 cm)**

- 2400-710 straight
- 2400-712 curved

**Classic / 4 1/8" (10.2 cm)**

- 13-7528 straight
- 13-7530 curved

**Classic / delicate / 4 1/8" (10.2 cm)**

- 13-7524 straight
- 13-7526 curved

**PC gold / 4 1/8" (10.2 cm)**

- 13-7532 straight
- 13-7533 curved

**PC gold / delicate / 4 1/8" (10.2 cm)**

- 13-7520 straight
- 13-7522 curved



**Iris Scissors**

**Classic / 4 1/2" (11.5 cm)**

- 13-7700 straight
- 13-7710 curved
- 13-7620 curved sideways
- 13-7715 angled sideways

**PC gold / 4 1/2" (11.5 cm)**

- 1200-025 angled sideways
- 1200-026 straight
- 1200-028 curved

**PC black / sharp tips / 4 1/2" (11.4 cm)**

- 2400-711 straight
- 2400-713 curved

**PC black / blunt / 4" (10 cm)**

- 2400-715 straight
- 2400-717 curved

**TC / 4 1/2" (11.5 cm)**

- 112-480 straight
- 112-478 curved

**TC/PC / 4 1/2" (11.5 cm)**

- 1200-502 straight
- 1200-503 curved

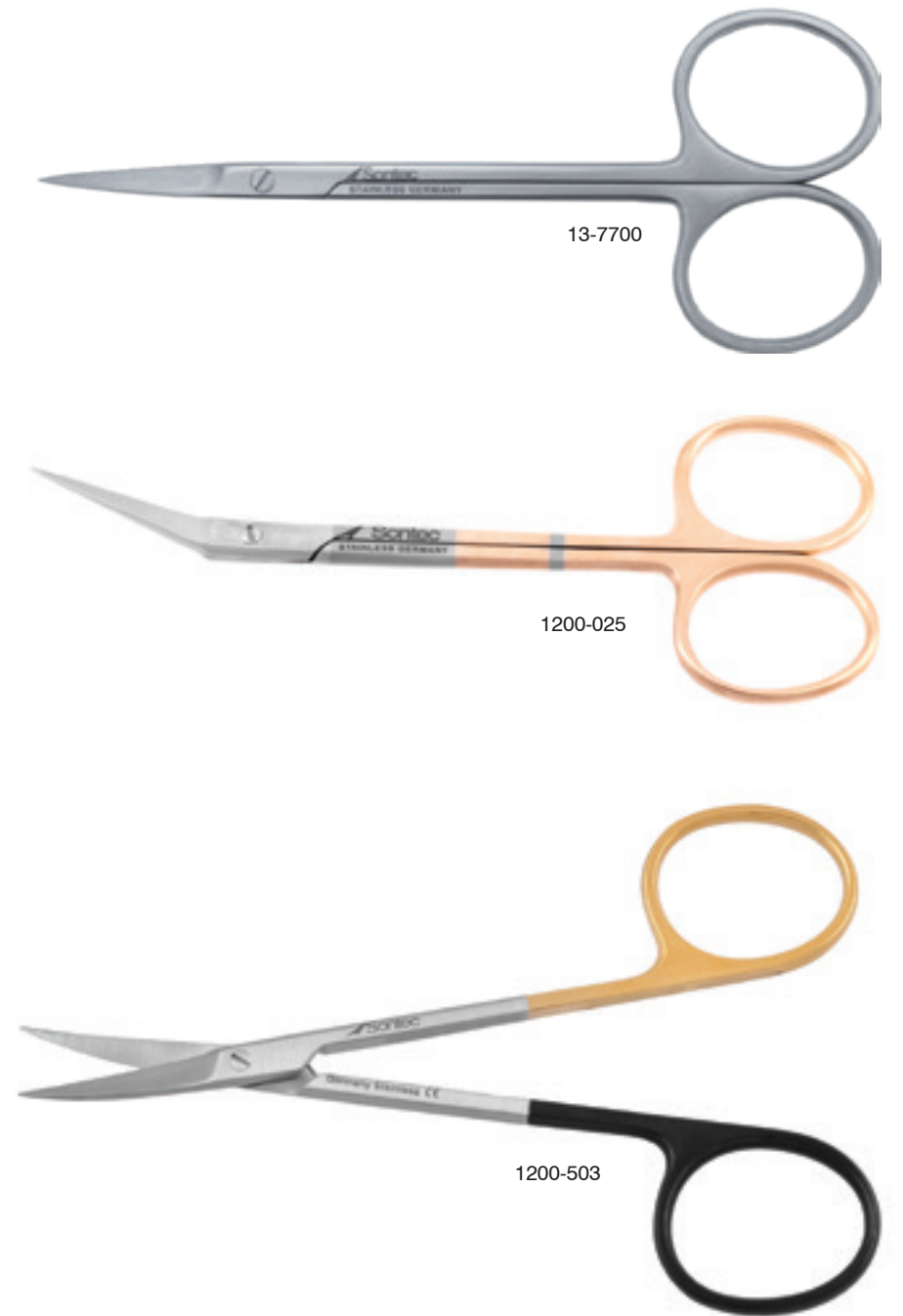

**Iris Stille Classic Large Cut Out Rings Scissors**

Curved / 4" (10.2 cm)  
13-7786

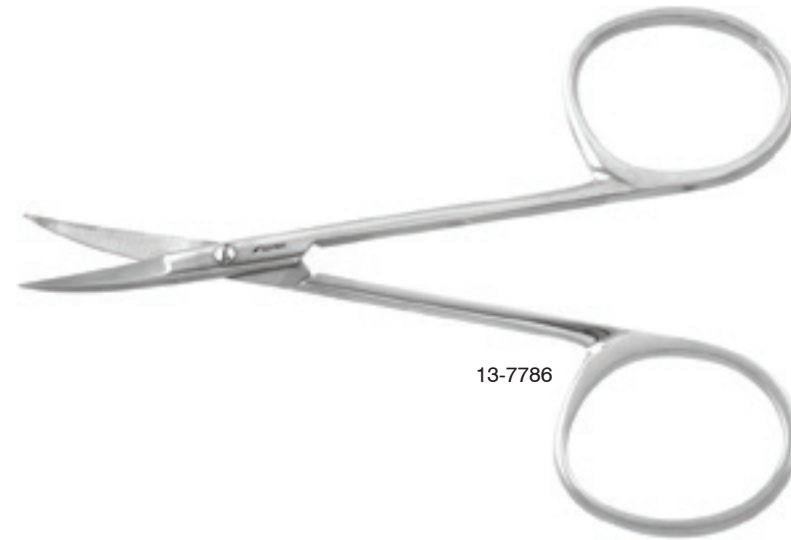

13-7786

**Iris Stille Classic Large Rings Scissors**

Large ring / Classic / 4" (10 cm)  
13-7740 straight  
13-7750 curved

Large ring / PC black / 4" (10 cm)  
1200-764 straight  
1200-766 curved

Large ring / PC gold / 4" (10 cm)  
1200-011 straight  
1200-011C curved



1200-766



1200-764

**Enucleation Scissors**

PC Gold / 5 1/4" (13 cm)  
13-9805 light curve  
13-9810 medium curve  
13-9820 full curve  
13-9822 full curve PC Black



13-9820



13-9822



light curve



medium curve



full curve

**Baby Stratte Scissors**

PC Gold / full s-curved / 5 1/2" (14 cm)  
508-616 metzenbaum tip  
508-618 tenotomy tip

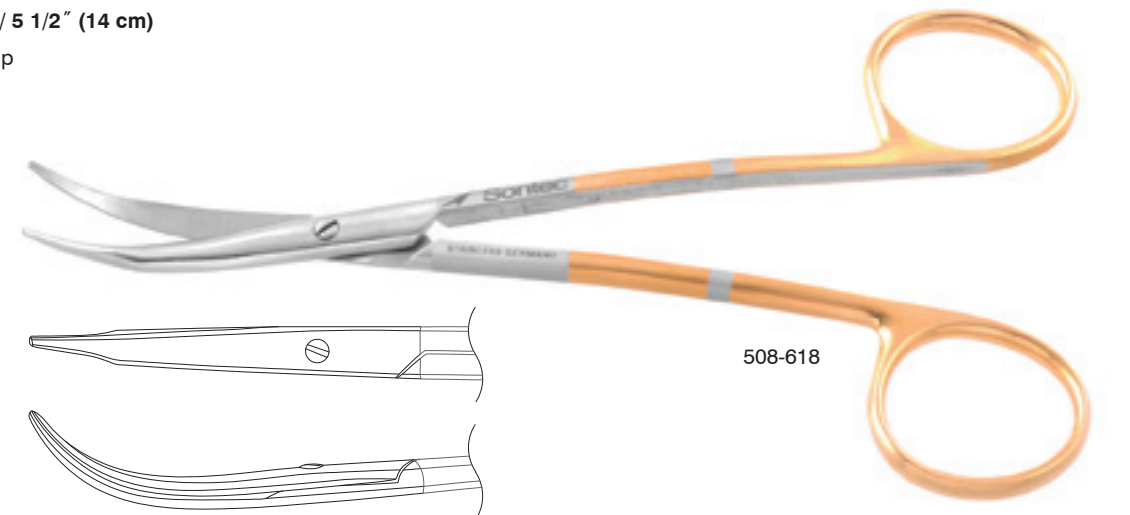

508-618

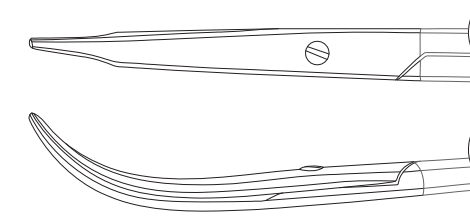

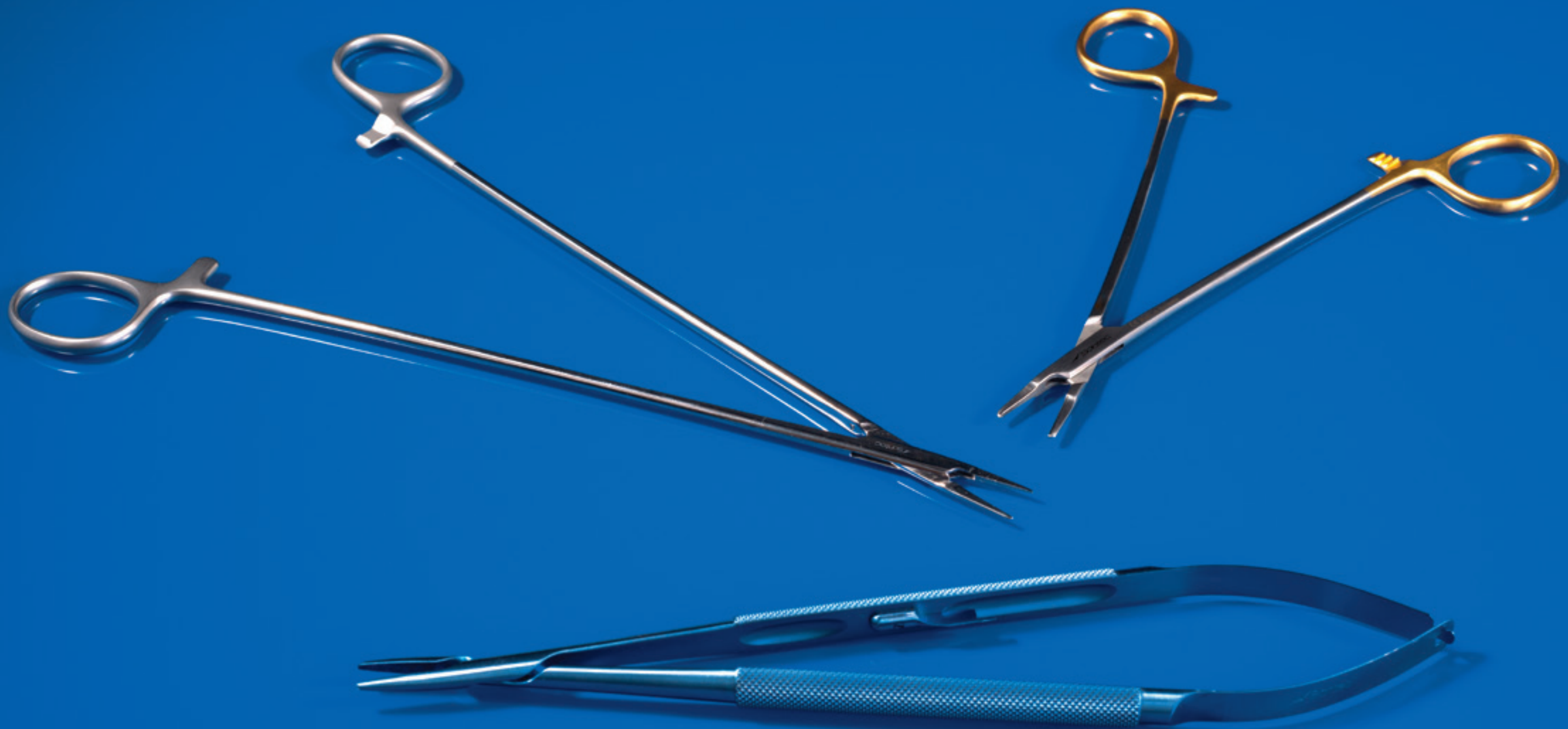

 Sontec Instruments®  
Needle Holders



**Gregory Needle Holder**

TC dust / straight / double action / round handle with lock / suggested suture size 7.0 and smaller

- 2300-048 7" (17.8 cm)
- T2300-048 7" (17.8 cm) titanium
- 2300-049 8 1/4" (21 cm)



2300-048



T2300-048



2300-049

**Sontec Extra Micro Needle Holder**

Round handle / TC dust / extra delicate jaws / specially serrated grip on shanks / 6" (15 cm) / suggested suture size 8-0 and smaller

- 400-254 str w/lock
- 400-256 cvd w/lock
- 400-250 str w/o lock
- 400-252 cvd w/o lock



400-254

**Castroviejo Needle Holder**

Round handle / TC dust / with lock / suggested suture size 7-0 and smaller

- 2300-020 str 4 3/4" (12 cm)
- 2300-024 cvd 4 3/4" (12 cm)
- 2300-030 str 5 3/4" (14.5 cm)
- 2300-034 cvd 5 3/4" (14.5 cm)
- 2300-038 str 6" (15 cm)



TC Insert straight



TC Insert curved

Round handle / with out lock / TC dust

- 2300-022 str 4 3/4" (12 cm)
- 2300-026 cvd 4 3/4" (12 cm)
- 2300-032 str 5 3/4" (14.5 cm)
- 2300-036 cvd 5 3/4" (14.5 cm)

Round handle / TC insert / with lock

- 2300-040 str 6" (15 cm)
- 2300-042 cvd 6" (15 cm)

Round handle / streamlined / TC serrated / with lock

- 2300-040S str 6" (15 cm)
- 2300-042S cvd 6" (15 cm)



2300-030



2300-042



2300-040S



2300-042S

### Jacobson Super Middle Weight Needle Holder Titanium

Mid-weight / with lock / TC dust / 8 1/2" (21.6 cm) / suggested suture size 5-0 and smaller

- 2600-712 standard box lock
- 2600-713 streamlined

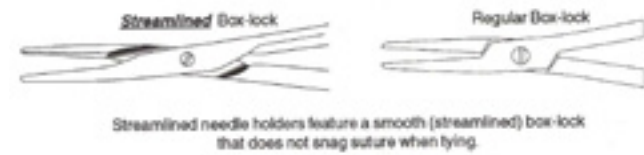

2600-712

### Jacobson Super Middle Weight Needle Holder

Mid-weight / with lock / TC serrated / straight / 1.8 mm jaw / suggested suture size 5-0 and smaller

- 2300-135M 7 1/4"
- 2300-143M 8 1/4"
- 2300-151M 9 1/8"

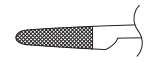

Mid-weight / with lock / TC dust / straight / suggested suture size 5-0 and smaller

- 2300-134M



2300-143M



2300-134M



2300-151M

### Double-Action SS Needle Holder

Stainless / TC dust / round handle / 7 1/4" (18.5 cm) / suggested suture size 5-0 and smaller

- 1103-888 straight
- 1103-887 straight universal lock
- 1103-888C curved
- 1103-887C curved universal lock

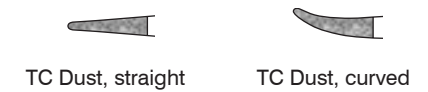

1103-887C

1103-887

### Barraquer Reverse Needle Holder

TC dust / round handle / with lock / inverted spring / suggested suture size 5-0 and smaller

- 2300-047 4 3/4" (12.1 cm)
- 2300-046 7" (17.8 cm)

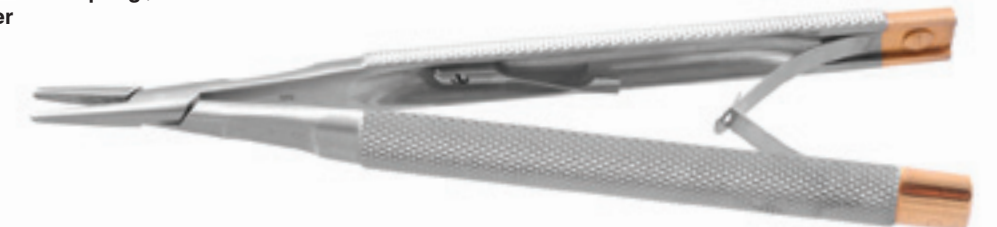

2300-047

### Glasser Micro Needle Holder

TC dust / round handle / with lock / inverted spring / suggested suture size 5-0 and smaller / 4 7/8" (12 cm)

- 2300-0496 straight
- 2300-0497 curved



2300-0496

TC dust / round handle / with lock / inverted spring / suggested suture size 5-0 and smaller / 7" (17.8 cm)

- 2300-0498 straight
- 2300-0499 curved



2300-0499

**Jacobson Micro Bayonet Needle Holder**

**Round handle / with lock / 8 1/4" (21 cm)**

- 400-228 TC insert str
- 400-229 TC insert cvd
- 400-230 TC dust str
- 400-231 TC dust cvd

**Round handle / with lock / 9" (23 cm)**

- 400-232 TC insert str
- 400-233 TC insert cvd
- 400-234 TC dust str
- 400-235 TC dust cvd

**Round handle / TC dust / with lock / 9" (23 cm)**

- 2300-258 micro tip str

**Flat handle / with lock / TC dust / 8 1/2" (22 cm)**

- 400-226 extra micro
- 400-227



**Castroviejo Needle Holder**

**Delicate jaw / 5 1/2"**

- 15-1800 straight w/o lock
- 15-1810 curved w/o lock
- 15-1820 straight w/ lock
- 15-1830 curved w/ lock



**Standard jaw / 5 1/2"**

- 15-1860 straight w/ lock
- 15-1880 curved w/ lock
- 15-1861 straight w/o lock
- 15-1881 curved w/o lock



**Delicate jaw / titanium / 5 1/2"**

- T15-1800 straight w/o lock
- T15-1810 curved w/o lock
- T15-1820 straight w/lock
- T15-1830 curved w/lock

**Standard jaw / titanium / 5 1/2"**

- T15-1860 straight w/lock
- T15-1880 curved w/lock
- T15-1861 straight w/o lock
- T15-1881 curved w/o lock

**McPherson Needle Holder**

**Very delicate jaw / suggested suture size 8.0 and smaller**

15-1310	straight	without lock	stainless	4"
15-1330	curved	without lock	stainless	4"
15-1300	straight	with lock	stainless	4"
15-1320	curved	with lock	stainless	4"
T15-1320	curved	with lock	titanium	4 1/8"
T15-1330	curved	without lock	titanium	4 1/8"
T15-1320R	curved	with lock	titanium	4 3/8"
T15-1330R	curved	without lock	titanium	4 3/8"

**Extra delicate jaw / fenestrated handle / with lock**

15-1300F	str	4 1/4"
15-1320F	cvd	4 1/4"



15-1300



15-1320



T15-1320R



T15-1330



T15-1330R



15-1320F

**Castroviejo Needle Holder**

**Flat handle / TC dust / 5 3/4" (14.5 cm) / suggested suture size 7-0 and smaller**

15-1916	str	w/o lock	
15-1917	cvd	w/o lock	
15-1912	str	w/lock	
15-1913	cvd	w/lock	
15-1914	str	w/lock	delicate
15-1915	cvd	w/lock	delicate

**Flat handle / TC dust / 5 3/4" (14.5 cm) / suggested suture size 7-0 and smaller / titanium**

T15-1916	str	w/o lock	
T15-1917	cvd	w/o lock	
T15-1912	str	w/lock	
T15-1913	cvd	w/lock	
T15-1914	str	w/lock	delicate
T15-1915	cvd	w/lock	delicate

**Flat handle / TC insert / 5 3/4" (14.5 cm) / suggested suture size 7-0 and smaller**

15-1900	str	w/ lock	
15-1910	cvd	w/ lock	
15-1901	str	w/o lock	
15-1911	cvd	w/o lock	



15-1912



15-1913



T15-1913



15-1900



15-1910



TC Smooth straight



TC Dust straight



TC Dust curved



TC Insert straight



TC Insert curved



TC Serrated

**Mathieu Heavy Needle Holder**

**Standard**

- 130-564 6 3/4" (17 cm) \*
- 130-565 8" (20 cm) \*

**Tungsten carbide serrated**

- 1100-094 6 3/4" (17 cm) \*
- 1100-098 8" (20 cm) \*
- 1100-096G 6 3/4" (17 cm) with finger grip

\* Also suitable as a wire twister

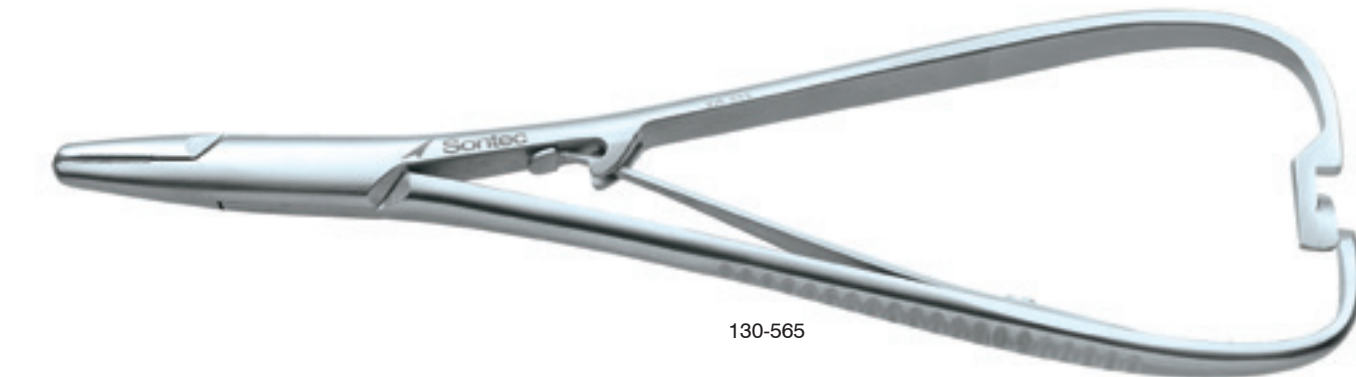
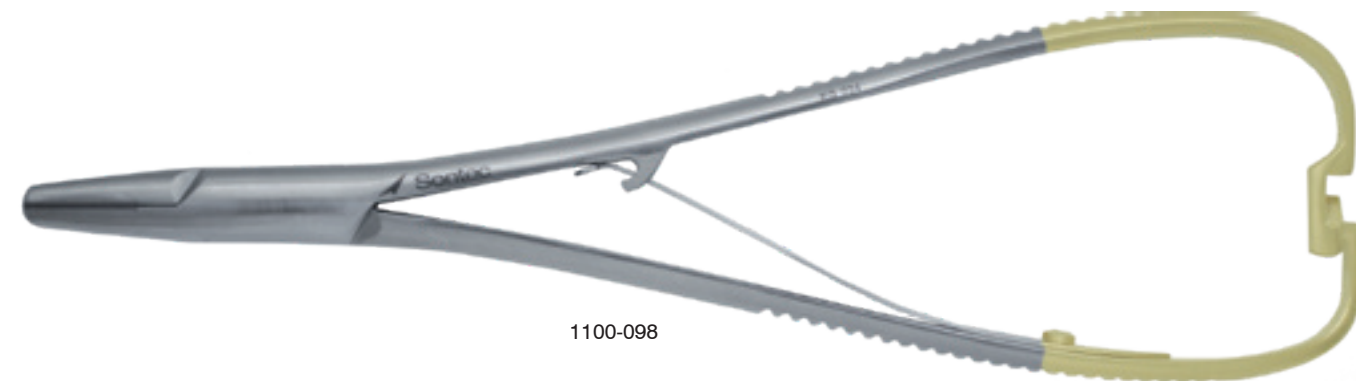
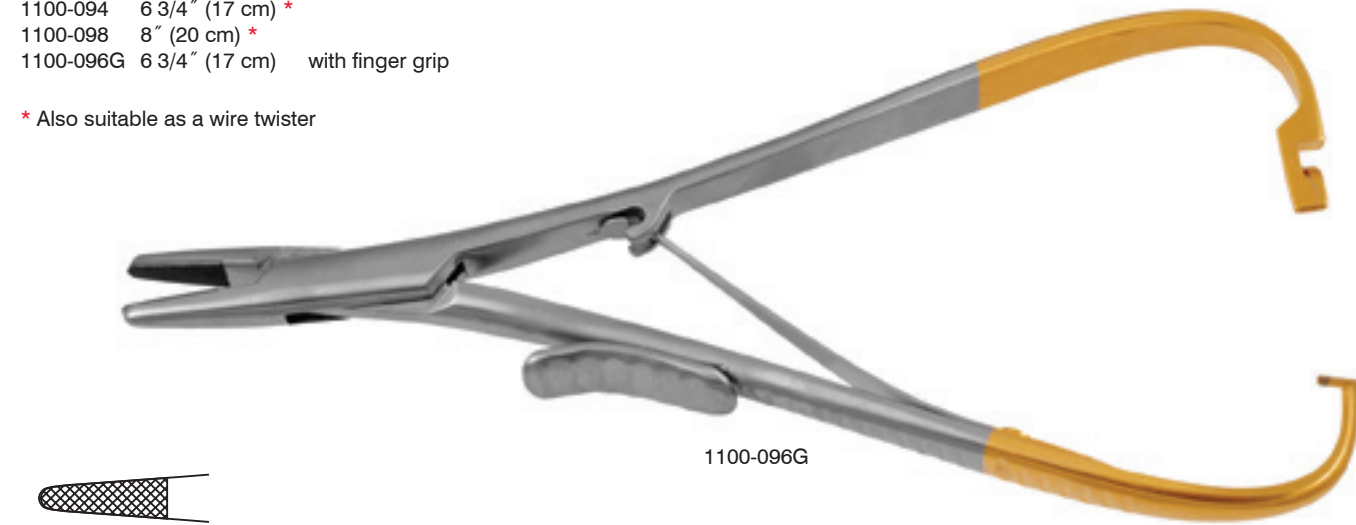

**Boynton Needle Holder**

**Delicate**

- 130-563 4 3/4" (12 cm) serrated without TC
- 132-450 4 3/4" (12 cm) TC serrated
- 132-452 6 1/4" (16 cm) TC serrated

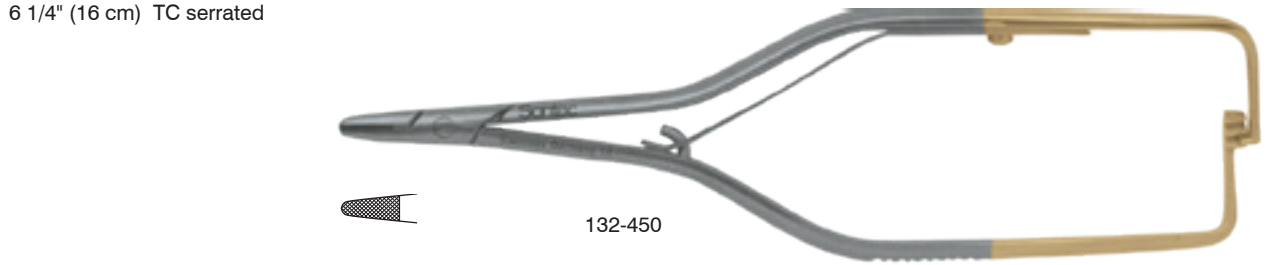

**Mathieu Needle Holder**

**Tungsten carbide / 6 1/2" (16.5 cm)**

- 1100-101 straight
- 1100-100 curved

**Tungsten carbide serrated**

- 1100-093 6 3/4" (17 cm) delicate
- 1100-091 8" (20.3 cm)
- 1100-090 9 1/2" (24 cm)

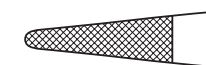

**Webster Needle Holder**

4 3/4" (12 cm)

- 1100-392 serrated w/out TC
- 2300-516 TC serrated
- 2300-518 TC smooth
- 2300-520 TC dust
- 2300-521 6" TC dust



2300-516



**Webster Needle Holder Titanium**

TC Dust / 4 3/4" (12.1 cm)

2600-725



2600-725

**Derf Needle Holder Titanium**

Mini / 4 1/4" (11 cm)

2600-714 TC dust



2600-714

**Halsey Needle Holder**

5" (12.5 cm)

- 130-517 serrated without TC/standard
- 130-518 smooth without TC/standard
- 132-372 TC serrated
- 132-374 TC smooth
- 132-373 TC Dust



132-372

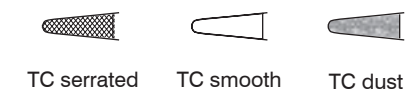

**Halsey Needle Holder Titanium**

5" (13 cm)

- 2600-720 TC Serrated
- 2600-722 TC Dust

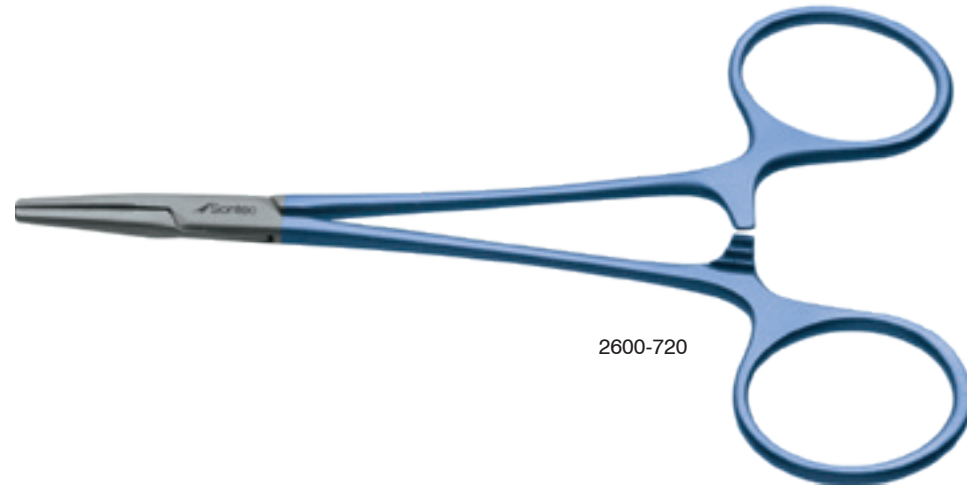

**Par Needle Holder**

TC serrated

- 132-367A 4 1/2" (11.5 cm)
- 132-367 5 1/4" (13 cm)



**Derf Needle Holder**

**Mini / 3 1/2" (9 cm)**

- 132-375 TC dust
- 132-376 TC serrated
- 132-376S TC smooth

**Mini / 4 1/4" (11 cm)**

- 132-632 TC serrated
- 132-634 smooth

**4 3/4" (12 cm)**

- 130-508
- 132-364 TC serrated
- 132-365 TC Dust

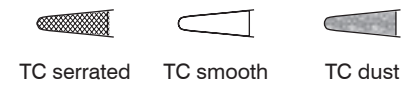

**Par Needle Holder Titanium**

**TC dust / 4 1/2" (11.4 cm)**

- 2600-728



**Neivert Needle Holder**

**TC serrated / offset rings / 5" (12.5 cm)**

- 132-380 single
- 132-380S double

**TC dust / 5" (12.5 cm)**

- 132-379 double
- 132-381 single

**TC smooth**

- 132-379S double
- 132-381S single

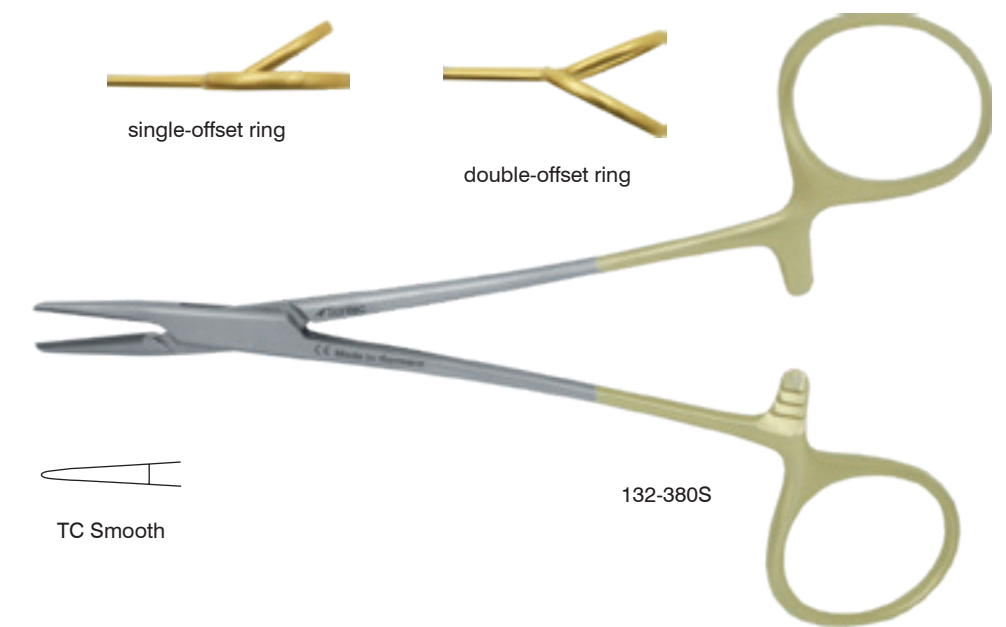
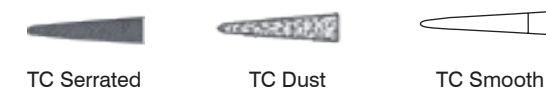
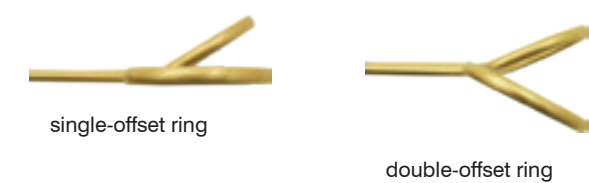



**Swedish Style Needle Holder**

**TC serrated / suggested suture size 5-0 and smaller**

- 2300-670 6" (15 cm)
- 2300-679 6" (15 cm) \*
- 2300-672 7" (18 cm)
- 2300-674 8" (20 cm)

**TC smooth / suggested suture size 5-0 and smaller**

- 2300-671 6" (15 cm)
- 2300-673 7" (18 cm)
- 2300-675 8" (20 cm)

\* Extra delicate

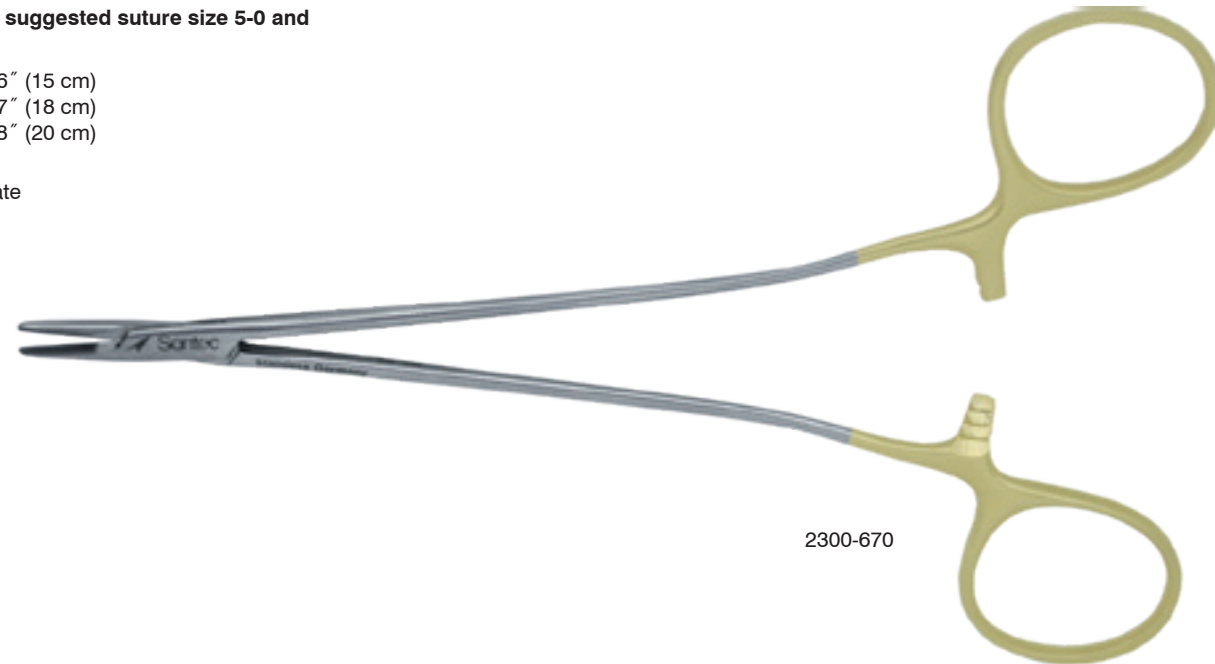

2300-670



TC Serrated      TC Serrated, extra delicate      TC Smooth

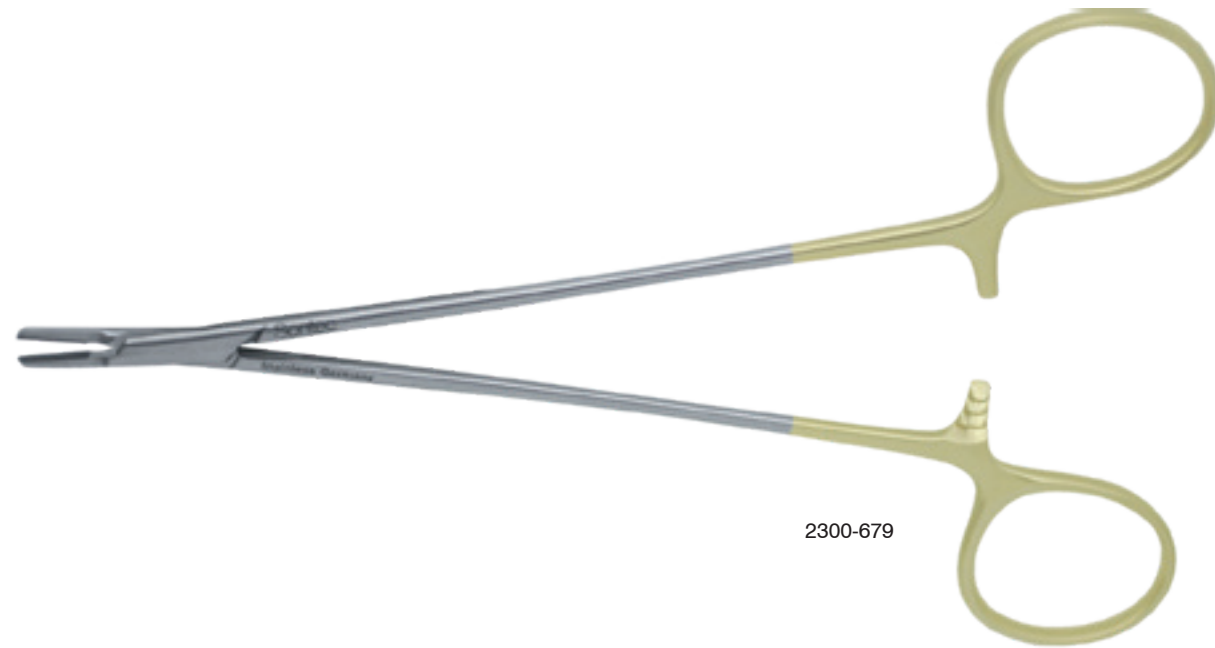

2300-679

**Ryder Delicate Needle Holder**

**1 mm jaw / TC serrated**

- |          |                |            |
|----------|----------------|------------|
| 2300-298 | 4 3/4" (12 cm) |            |
| 2300-300 | 5" (12.5 cm)   |            |
| 2300-301 | 5" (12.5 cm)   | 1.5 mm jaw |
| 1100-122 | 5" (12.5 cm)   | 2 mm jaw   |
| 2300-302 | 6" (15 cm)     |            |
| 2300-304 | 7" (18 cm)     |            |
| 2300-306 | 8" (20 cm)     |            |
| 2300-308 | 9" (23 cm)     |            |

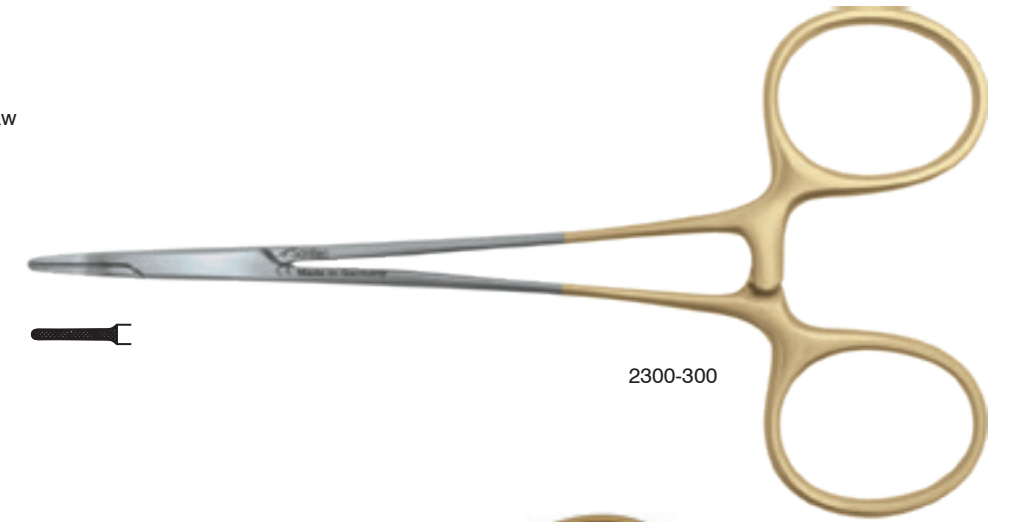

2300-300

**1 mm jaw / TC smooth**

- |           |                |
|-----------|----------------|
| 2300-298S | 4 3/4" (12 cm) |
| 2300-300S | 5" (12.5 cm)   |
| 2300-302S | 6" (15 cm)     |
| 2300-304S | 7" (18 cm)     |
| 2300-306S | 8" (20 cm)     |
| 2300-308S | 9" (23 cm)     |



2300-301

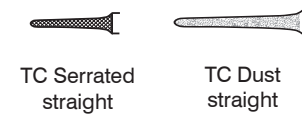

TC Serrated straight      TC Dust straight

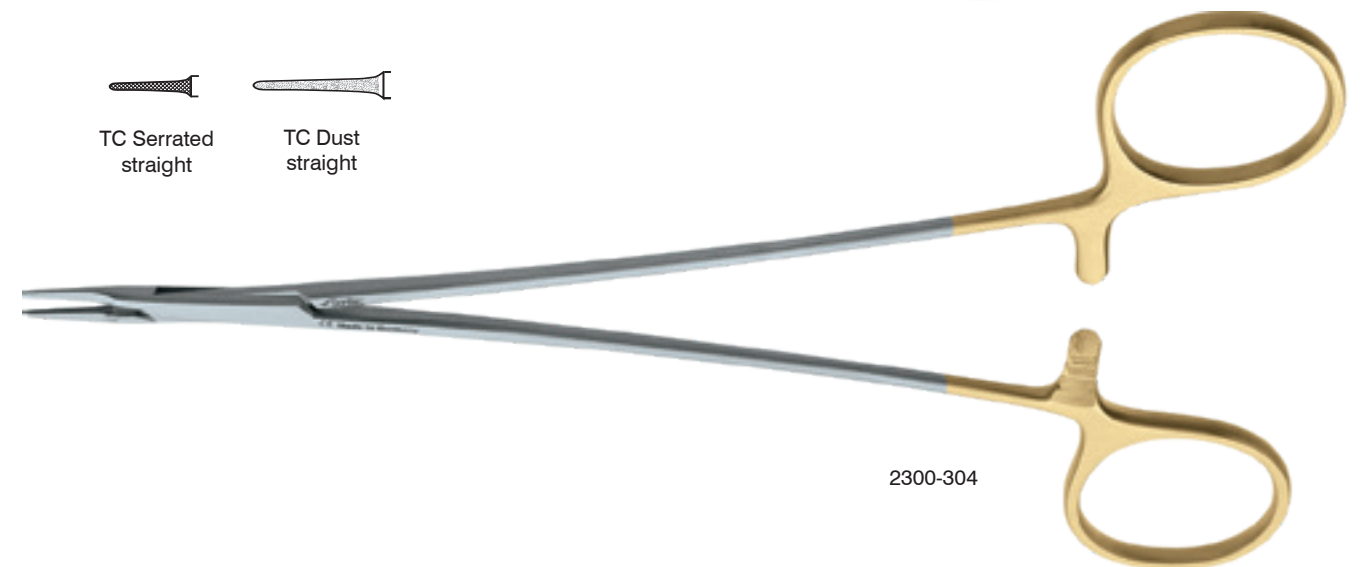

2300-304

**Microvascular Needle Holder**

TC dust / streamlined box lock / suggested suture size 5-0 and smaller

2300-350	str	5" (12.5 cm)
2300-352	cvd	5" (12.5 cm)
2300-354	str	5 3/4" (14.5 cm)
2300-356	cvd	5 3/4" (14.5 cm)
2300-358	str	6 1/4" (16 cm)
2300-360	cvd	6 1/4" (16 cm)
2300-362	str	7 1/4" (18.5 cm)
2300-366	str	7 1/4" (18.5 cm) *
2300-364	cvd	7 1/4" (18.5 cm)
2300-368	str	8 7/8" (22.8 cm)
2300-370	cvd	8 7/8" (22.8 cm)
2300-372	str	10" (25 cm)
2300-374	cvd	10" (25 cm)

\* Left handed

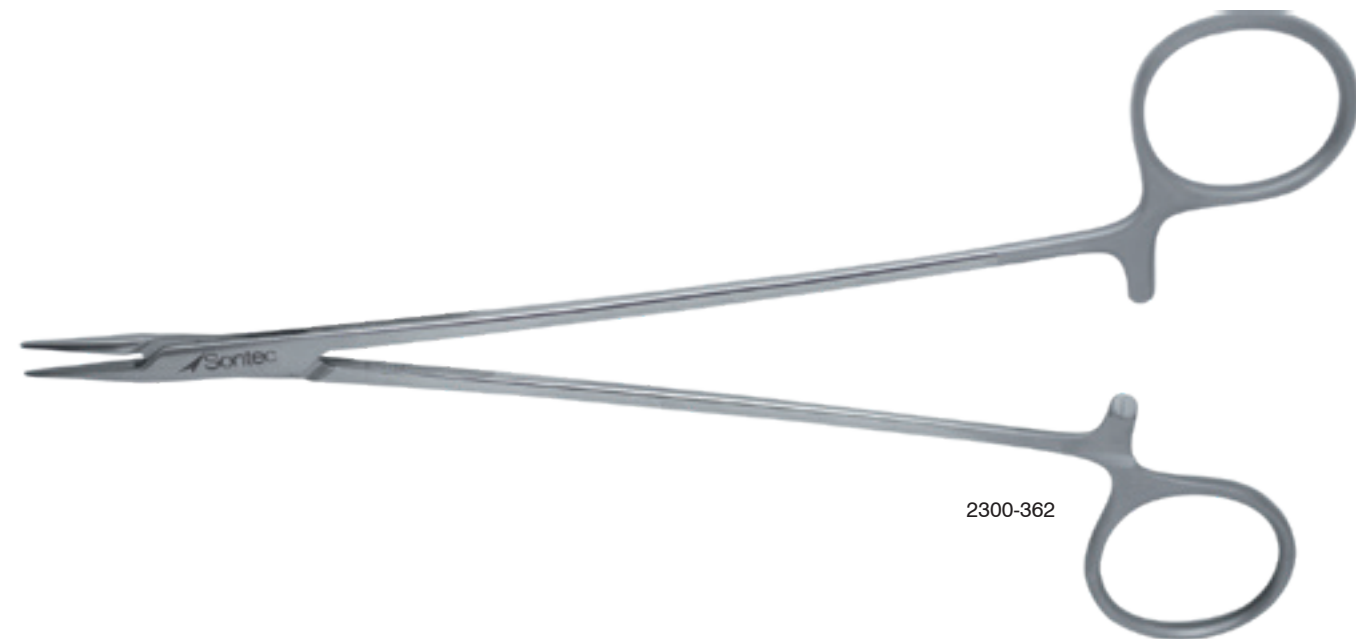
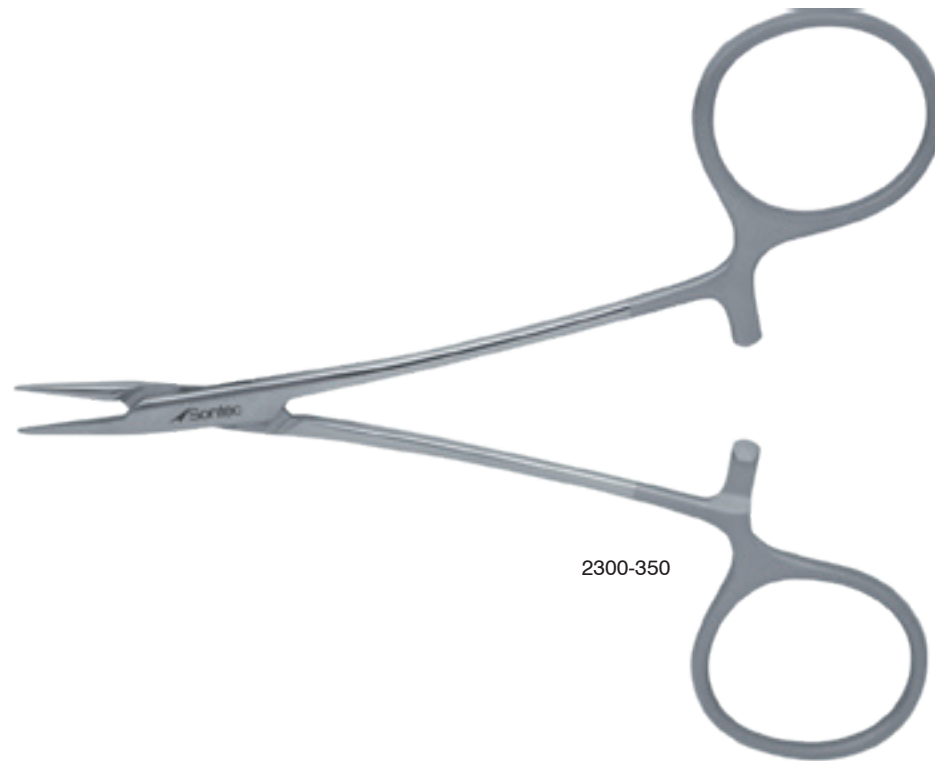
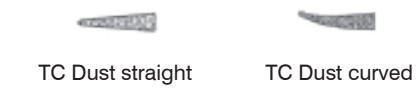

**Crile-Wood Needle Holder**

Serrated without TC

130-521	6" (15 cm)
130-523	7" (18 cm)
130-525	8" (20 cm)
130-526	9" (23 cm)

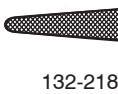

TC Serrated

132-388	str	6" (15 cm)
132-210	str	7" (18 cm)
132-223	cvd	7" (18 cm)
132-212	str	8" (20 cm)
132-225	cvd	8" (20 cm)
132-214	str	9" (23 cm)
132-224	cvd	9" (23 cm)
132-216	str	10" (25 cm)
132-218	str	12" (30 cm)



Streamlined box lock / TC serrated

2300-378	6" (15 cm)
2300-384S	7" (18 cm)
2300-388S	8" (20 cm)
2300-390S	9" (23 cm)
2300-394S	10" (25 cm)
2300-396S	12" (30 cm)

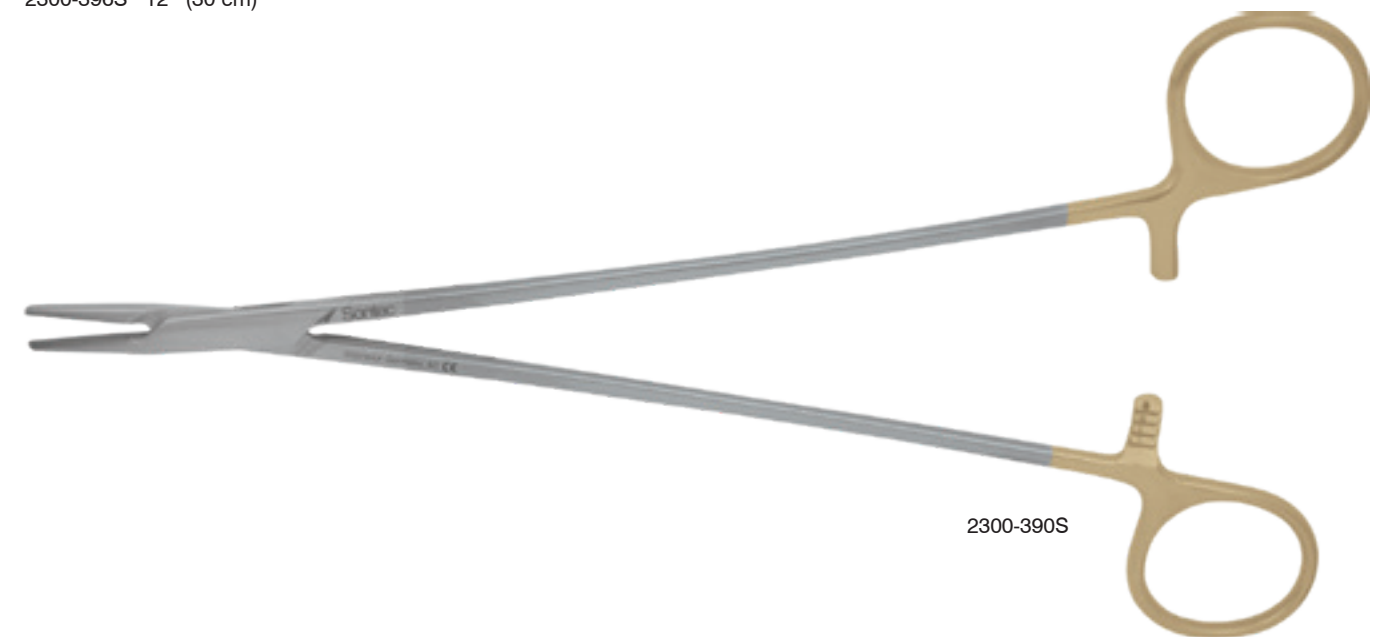

**Baumgartner Needle Holder**

Mini Mayo Hegar / tungsten carbide / 5" (12.5 cm)

132-110



**Collier Needle Holder**

Fenestrated tip / 5" (12.5 cm)

130-514



**Mayo-Hegar Needle Holder**

Serrated jaws without TC

- 130-527 6 1/4" (15 cm)
- 130-529 7 1/4" (18 cm)
- 130-531 8" (20 cm)



130-527



130-529



130-531

Tungsten carbide serrated jaws

- 2300-328 5 3/4" (14.6 cm)
- 132-115 6 1/4" (15 cm)
- 132-118 7 1/4" (18 cm)
- 132-120 8" (20 cm)
- 132-122 9" (23 cm)
- 132-123 10" (25 cm)
- 132-125 12" (30 cm)
- 1100-853 14" (35 cm)
- 1100-851 16" (40 cm)
- 1100-854 18" (45 cm)



132-115



132-118



**Sontec-Olsen-Hegar Deluxe Needle Holder**

Tungsten carbide jaws / unique jaw design

- 1100-108D 6 3/4" (17 cm)
- 1100-110D 7 3/4" (19.5 cm)



**Sontec Olsen-Hegar Needle Holder**

Unique jaw design / tungsten carbide

- 1100-106 5 1/2" (14 cm)
- 1100-106A 5 1/2" (14 cm) delicate
- 1100-108 6 1/2" (16.5 cm)



1100-106A



**Olsen-Webster Needle Holder**

4 3/4" (12 cm)

- 1103-601 serrated w/out TC/standard
- 132-362 TC serrated
- 132-359 TC serrated delicate
- 132-360 TC smooth
- 1103-604 TC dust delicate
- 132-361 TC dust
- 132-362D TC serrated \*
- 132-362S TC offset ring

\* Double offset ring

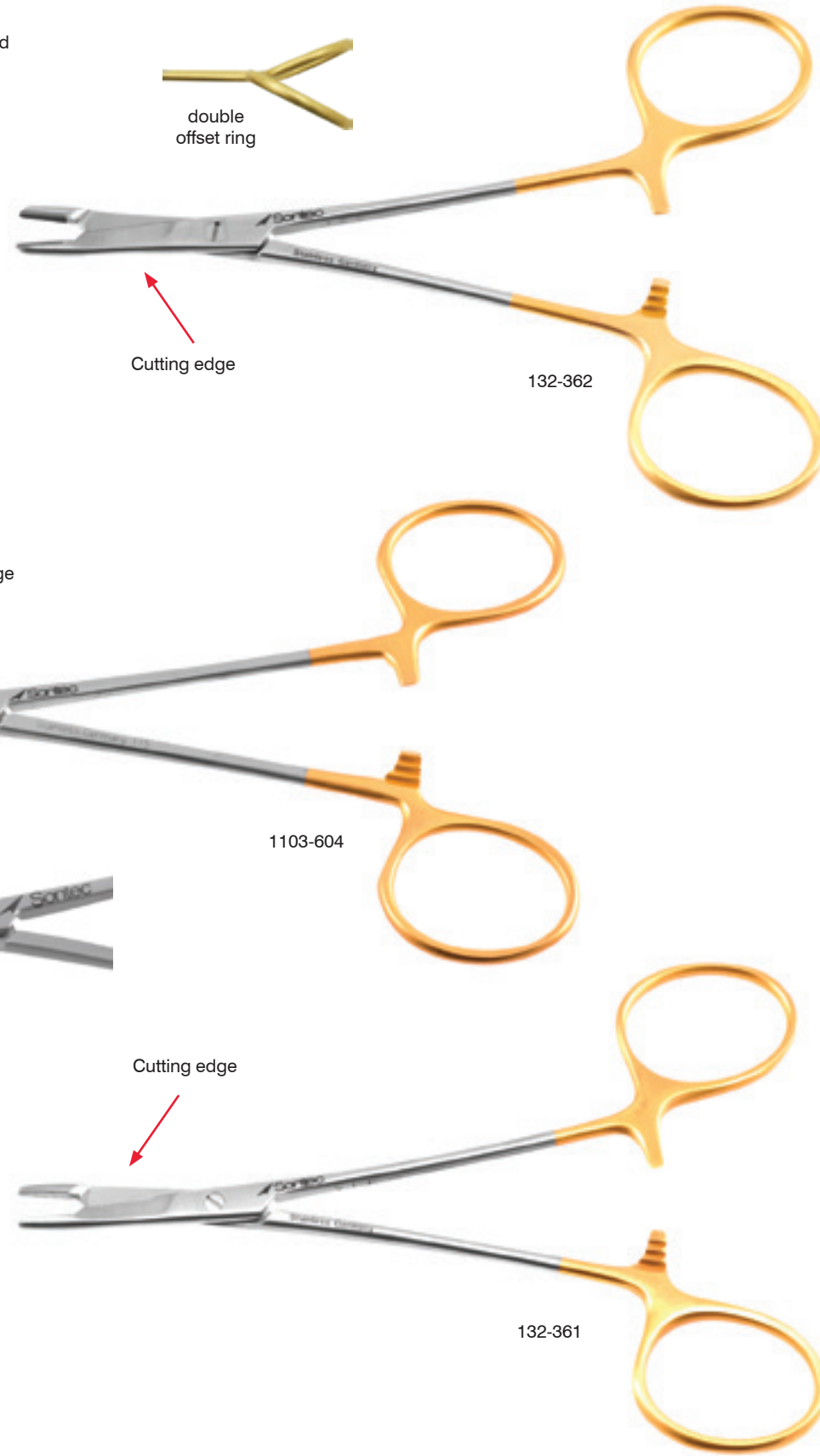

**Foster-Gillies Needle Holder**

TC serrated

- 132-387 straight 3 7/8" (10 cm)
- 132-382 angled 4 3/4" (12 cm)
- 132-383 curved 5 3/4" (14.5 cm)
- 132-382L angled 4 3/4" (12 cm) \*
- 132-383L curved 5 3/4" (14.5 cm) \*

\* Left handed

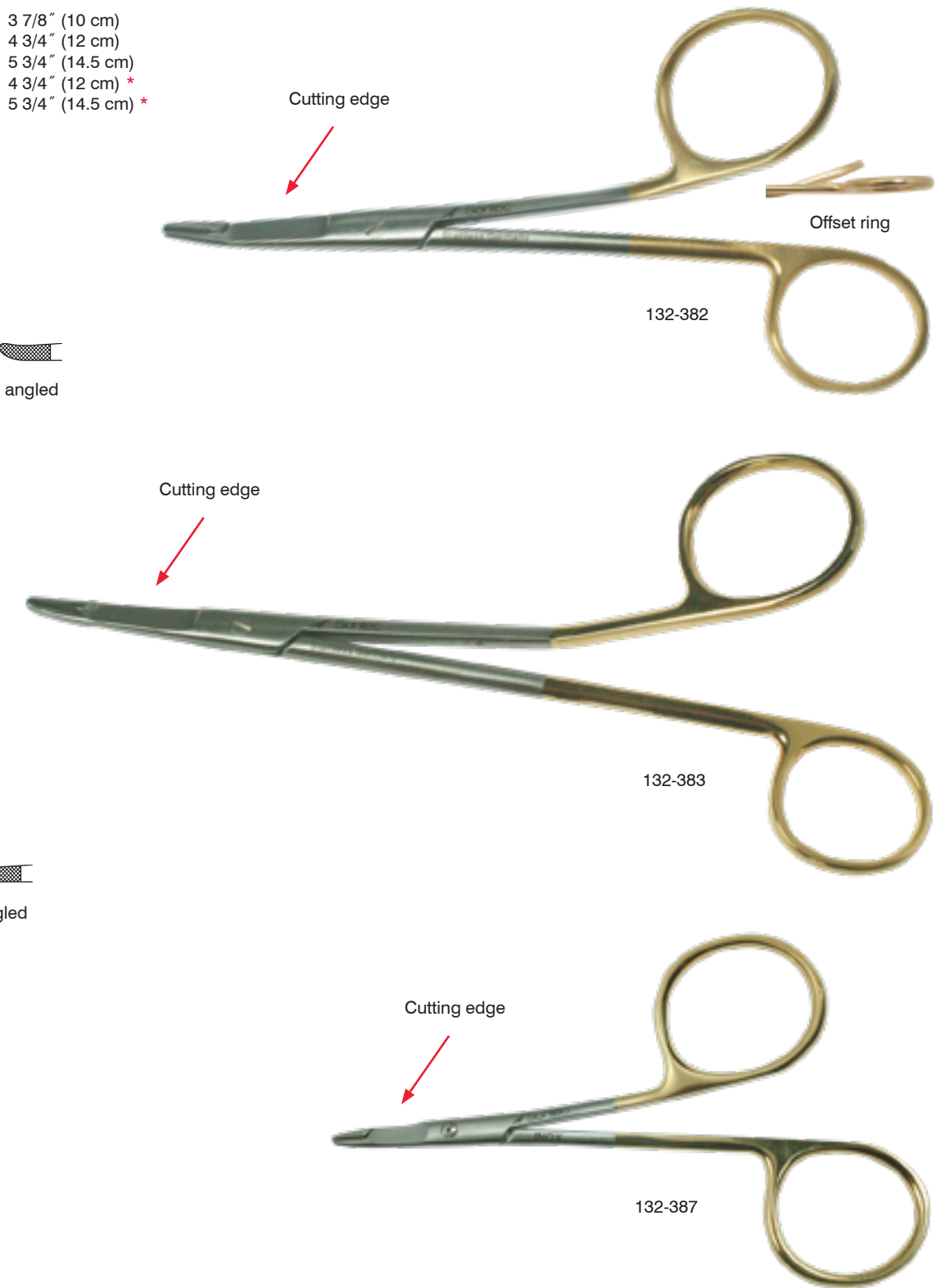

**Gillies Needle Holder**

Curved / 6 1/8" (15.5 cm)

- 132-384C TC serrated
- 132-384D TC dust
- 132-384L left handed

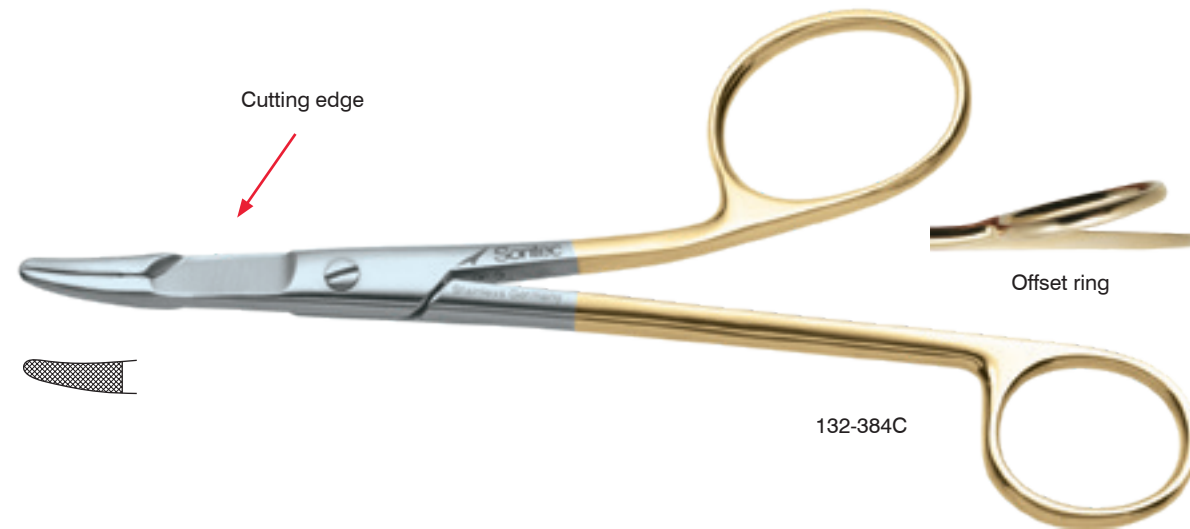

**Sternal Wire Twister Needle Holder**

Broad jaw / TC serrated / can be used as a wire twister / suggested suture size sternal needles and smaller

- 1103-154S 5 1/8" (13 cm)
- 1103-152 7" (18 cm)
- 1103-153 7 3/4" (19.5 cm)

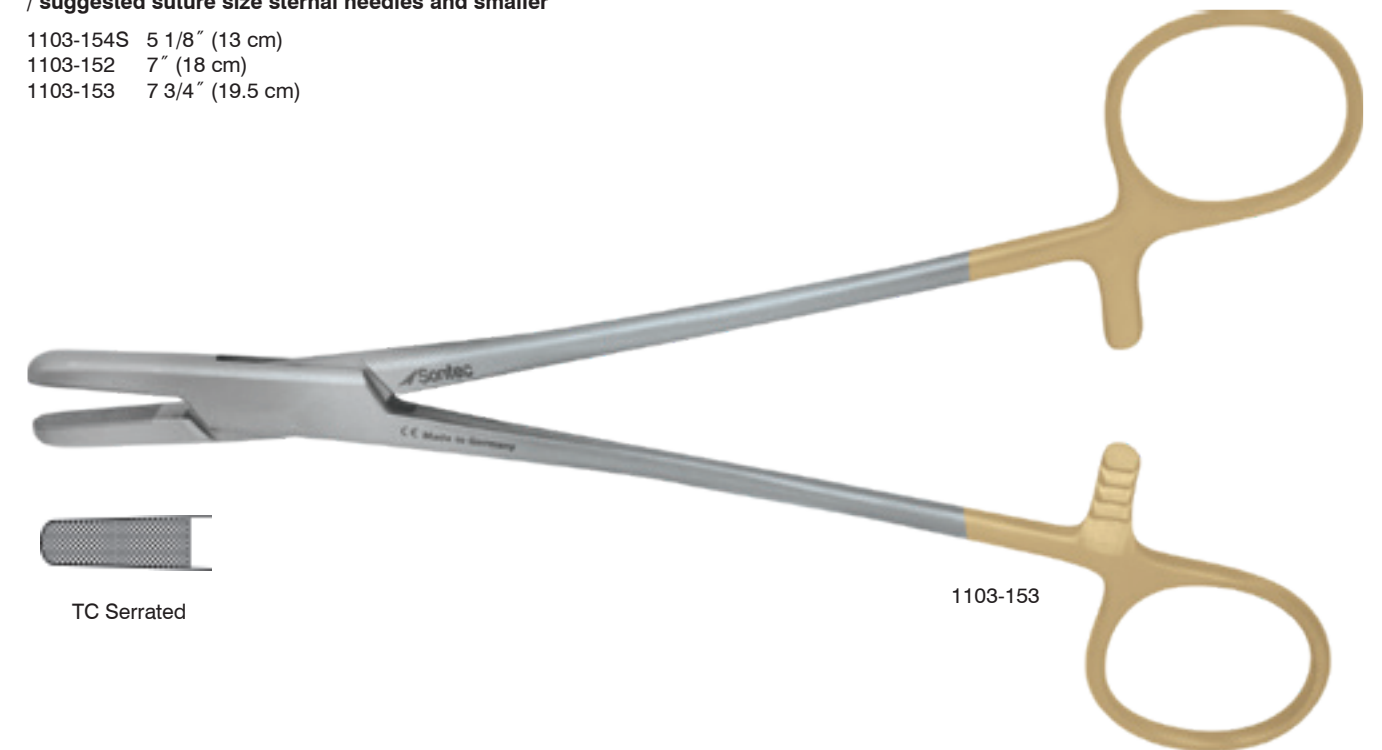

**New Orleans Wire Twister Needle Holder**

TC serrated / suggested suture size 2-0 and smaller

- 2300-600 rounded 6" (15 cm)
- 2300-602 blunt 6" (15 cm)
- 2300-601 rounded 7" (18 cm)
- 2300-604 blunt 7" (18 cm)
- 2300-606 rounded 8" (20.5 cm)
- 2300-607 blunt 8" (20.5 cm)

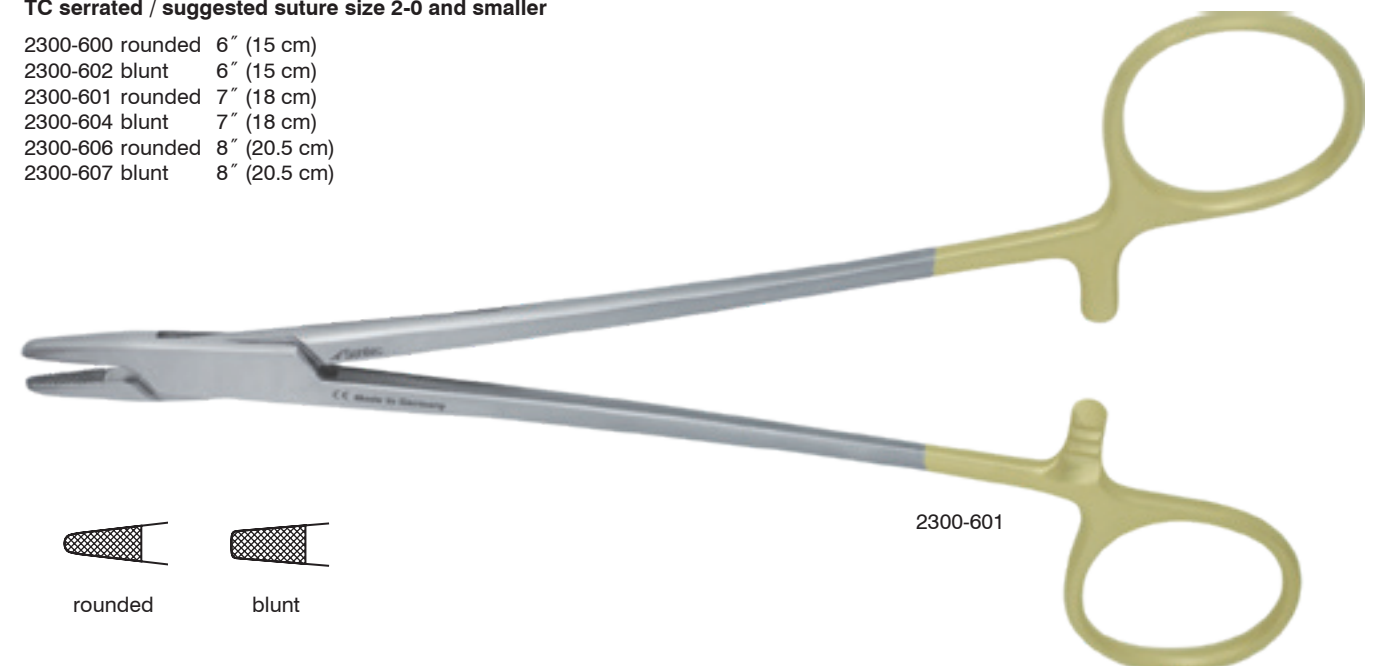

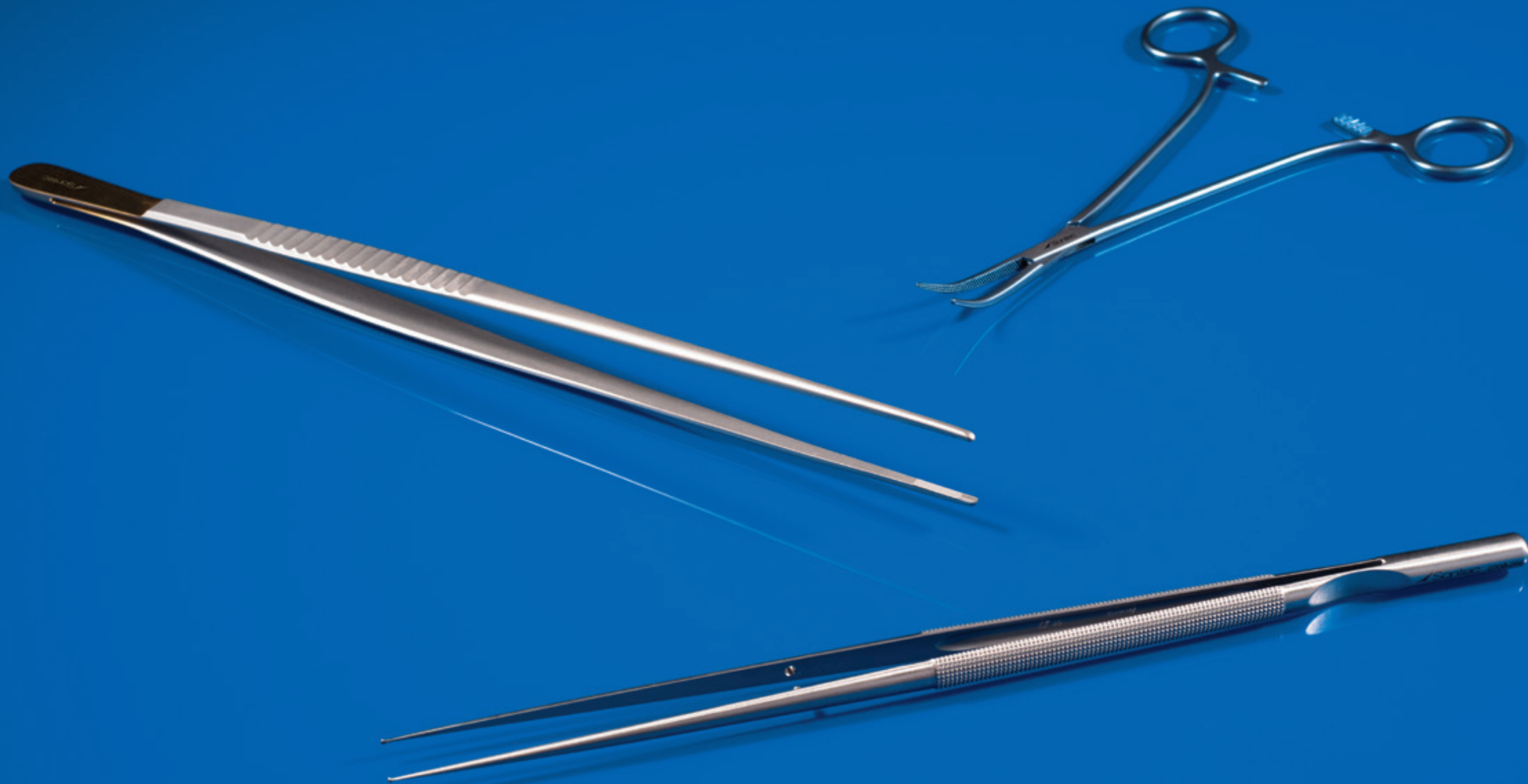

 Sontec Instruments®

Forceps

**Jewelers Classic Forceps**

**#1 / standard handle / extra delicate**

14-6810 stainless  
T14-6810 titanium



14-6810

**#2 / standard handle / delicate / stair**

14-6815  
14-6816 TCD  
T14-6816 titanium



**#3 / standard handle / standard**

14-6830 stainless  
T14-6830 titanium



14-6815

**#3 / standard handle / standard / stainless / TCD**

14-6831



14-6830

**#3C / standard handle / short**

14-6820 stainless  
T14-6820 titanium



**#3C / standard handle / standard / stainless / TCD**

14-6821



T14-6820

**#4 / standard handle / standard**

14-6840 stainless  
T14-6840 titanium



14-6840

**#5 / standard handle / extra delicate**

14-6850 stainless  
T14-6850 titanium



T14-6850

**#7 / standard handle / curved**

14-6870 stainless  
T14-6860 titanium



T14-6860

**Adson Tissue TC Serrated Platform Forceps**

**1 x 2 teeth / TC serrated platform / serrated handle / 4 3/4"**

140-305 1.0 mm  
140-304 1.3 mm  
140-303 1.8 mm



140-303



140-304

**1 x 2 teeth / TC serrated platform / serrated handle / 6"**

140-207 0.8 mm  
140-309 1.0 mm  
140-202 1.3 mm  
140-203 1.8 mm



140-309

**1 x 2 teeth / TC serrated platform / fenestrated handle / 4 3/4"**

140-305F 1.0 mm  
140-3042 1.3 mm  
140-3032 1.8 mm



140-305F

**2 x 3 teeth / TC serrated platform / serrated handle / 4 3/4"**

140-306 0.8 mm  
140-307 1.0 mm



140-307

**2 x 3 teeth / TC serrated platform / fenestrated handle / 4 3/4"**

140-304F 1.0 mm



140-304F



**Stille-Adson Dressing Forceps**

Serrated / 4 3/4" (12 cm)

136-659  
136-659D delicate



**Brown Forceps**

9x9 teeth / castroviejo handle / 4 1/4" (10.8 cm)

14-6560  
14-6562 with TC dust platform  
14-6564 with TC insert



**Adson Tissue Forceps Titanium**

TC dust / 1.0 mm tips / 4 3/4" (12 cm)

140-298T



**Adson Tissue Forceps Titanium**

1 x 2 / TC dust / tying platform / 4 3/4" (12 cm)

140-304T



**Brown-Adson Tissue Forceps**

Serrated handle / 7 x 7 teeth / 4 3/4" (12 cm)

136-688 fenestrated handle  
136-688S



3 x 4 teeth / TC platform / 4 3/4" (12 cm)

136-689 serrated handle  
1100-735F fenestrated handle

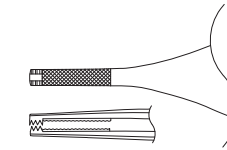

3 x 4 teeth / TC platform / electro black coated / 4 3/4" (12 cm)

136-6891 serrated handle



Russian fenestrated handle / 8 x 8 teeth / 4 3/4" (12 cm)

136-700



Serrated handle / 9 x 9 teeth / 4 3/4" (12 cm)

136-686  
136-686D delicate  
136-698 angled

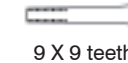

Serrated handle / TC platform / 9 x 9 teeth / 4 3/4" (12 cm)

136-689

Serrated handle / 9 x 9 teeth / 6" (15.5 cm)

136-687  
136-697 TC platform



**Adson Dressing Serrated Forceps**

Serrated tip / serrated handle / 4 3/4"

- 136-6621T 0.4 mm
- 136-662 0.8 mm
- 136-662T 0.8 mm
- 136-660 1.3 mm
- 136-660A 1.3 mm angled



136-660

Serrated tip / fenestrated handle / 4 3/4"

- 136-663 0.8 mm
- 136-661 1.3 mm

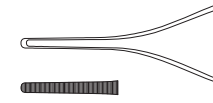

Serrated tip / serrated handle / 6"

- 140-198 1.3 mm

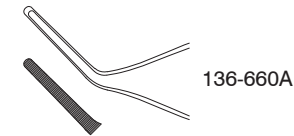

136-6621T



136-662T

**Adson Dressing TC Serrated Platform Forceps**

TC Serrated platform / serrated handle / 4 3/4"

- 140-299 0.8 mm
- 140-301 1.3 mm



140-299

TC Serrated platform / serrated handle / 6"

- 140-201 1.3 mm



140-301

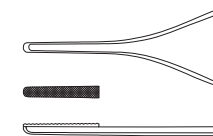

**Brown Adson Tissue Forceps Titanium**

1.8 mm tips / 7x7 teeth

- T136-688 4 3/4" (12 cm) fenestrated handle
- 136-688T 6" (15.2 cm)



T136-688

1.8 mm tips / 9x9 teeth / 4 3/4" (12 cm)

- T136-686 4 3/4" (12 cm)



136-688T



T136-686

**Gorney-Adson Forceps**

1 x 2 teeth with platform / stop pin, 4 3/4" (12 cm)

- 136-6741



136-6741

**Adson Dressing Cross-Serrated Forceps**

Cross-serrated tip / serrated handle / 4 3/4"

- 136-664D 0.8 mm
- 136-664 1.3 mm



136-664

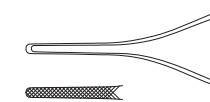

Cross-serrated tip / 4 3/4"

- 136-665 1.3 mm



136-664D

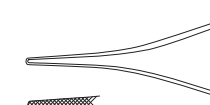

**Beasley-Babcock Tissue Forceps**

Serrated adson handle / 5 x 6 teeth / 5" (13 cm)

136-699



136-699

**Adson Tissue Smooth Platform Forceps**

1 x 2 teeth / smooth platform / serrated handle / 4 3/4"

136-668A 0.8 mm  
136-674D 1.0 mm  
136-674 1.3 mm

1 x 2 teeth / smooth platform / fenestrated handle / 4 3/4"

136-679 1.3 mm



136-674



136-679

**Adson Tissue TC Dust Platform Forceps**

1 x 2 teeth / TC Dust platform / serrated handle / 4 3/4"

140-302D 0.8 mm  
140-302 1.0 mm

1 x 2 teeth / TC Dust platform / fenestrated handle / 4 3/4"

140-302F 0.8 mm  
140-303F 1.0 mm



140-303F

**Adson Tissue Smooth Platform Forceps**

1 x 2 teeth / smooth platform / serrated handle / 4 3/4"

136-668A 0.8 mm  
136-674D 1.0 mm  
136-674 1.3 mm

1 x 2 teeth / smooth platform / fenestrated handle / 4 3/4"

136-679 1.3 mm



136-674



136-679

**Iris Dressing Forceps**

Serrated / 0.5 mm tip / delicate / 4" (10 cm)

14-4300 straight  
14-4310 half curve  
14-4305 full curve

Serrated / 0.8 mm tip / standard / 4" (10 cm)

14-4340 straight  
14-4345 half curve  
14-4350 full curve

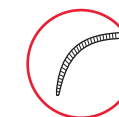
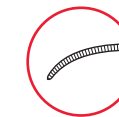
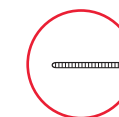

14-4300

**McIndoe Dressing and Tissue Forceps**

Fine serrations / 6" (15 cm)  
2200-750



2200-750

Cross serrations with 1x2 teeth / 6" (15 cm)  
2200-752



2200-752

**Gillies Forceps**

Fine serrations / 1 x 2 teeth / 6" (15 cm)  
2200-700



2200-700

**Erhardt Lid Clamp Forceps**

Oval  
14-9700



14-9700

**Graefe Fixation Forceps**

4.5 mm jaw / 4 1/2" (11.5 cm)  
14-5120 with lock  
14-5122 with lock curved  
14-5130 without lock



14-5120



14-5122



14-5130

**Green Fixation Forceps**

Atraumatic integrating teeth / 4" (10 cm)  
14-5200 5 mm jaw  
14-5205 5 mm jaw with lock  
14-5215 10 mm jaw with lock  
14-5220 10 mm jaw

Titanium / atraumatic integrating teeth / 4" (10 cm)  
T14-5220 10 mm jaw  
T14-5200 5 mm jaw



14-5215



14-5220



T14-5220

**Cottle Columella Clamp Forceps**

14 mm tip / with locking thumb screw / 4" (19 cm)  
14-9730



14-9730

**Heath Chalazion Clamp Forceps**

Oval / 16 mm x 14 mm  
14-9740



14-9740

**Lambert Chalazion Clamp Forceps**

Round / 8mm  
14-9750



14-9750

**Hunt Chalazion Clamp Forceps**

Round / 12 mm  
14-9800



14-9800

**Baird Chalazion Clamp Forceps**

Small oval / 11 x 18 mm I.D.  
14-9850 stainless steel  
T14-9850 titanium



14-9850



T14-9850

**Sontec Eye Lid Forceps**

Serrated / 5" (12.5 cm)  
14-5240



14-5240

**Desmarres Chalazion Clamp Forceps**

Lower solid blade / stainless  
14-9900 17 mm  
14-9901 21 mm  
14-9902 28 mm



14-9901

Lower solid blade / laser finished  
14-9893 17 mm  
14-9894 21 mm  
14-9895 28 mm

Lower solid blade / blue electro coat  
14-9896 17 mm  
14-9897 21 mm  
14-9898 28 mm



small (17 mm)

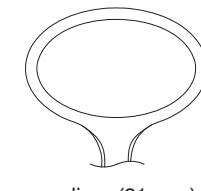

medium (21 mm)

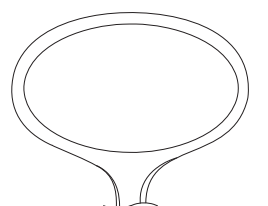

large (28 mm)

**Desmarres Severin Chalazion Clamp Forceps**

Two open tips / both blades fenestrated  
14-9908 17 mm  
14-9907 21 mm  
14-9906 28 mm



14-9908

Two open tips / both blades fenestrated  
T14-9908 17 mm  
T14-9907 21 mm  
T14-9906 28 mm



17 mm



21 mm



28 mm



T14-9908



T14-9907

**Putterman Clamp Forceps**

14-9400	stainless	slide lock
T14-9400	titanium	slide lock
14-9410	stainless	screw lock



**Francis Chalazion Clamp Forceps**

**Medium oval**  
14-9870



**Lordan Chalazion Clamp Forceps**

**Triangular**  
14-9910



**Snellen Entropium Clamp Forceps**

**18 x 35 mm jaw**  
14-9920 right  
14-9925 left

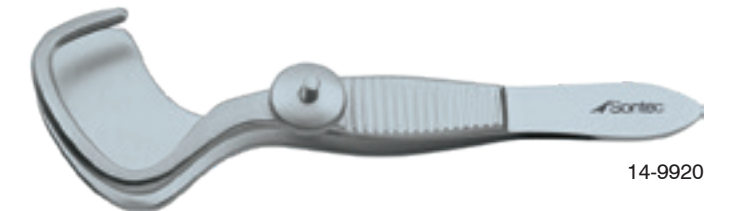

**Castroviejo Lip Graft Clamp Forceps**

**U-shaped / closed end**  
14-9725



**Jones Towel Clamp Forceps**

**Cross action / stainless**  
14-9990 2 1/4" (5.5 cm)  
14-9992 3 1/2" (7.5 cm)

**Cross action / titanium**  
T14-9990 2 1/2" (6 cm)



**Bonaccolto Suture Forceps**

Conjunctiva forceps / longitudinally serrated jaws / with cross serrations at tips / straight

14-6500 1.2 mm tip  
14-6510 1.7 mm tip



14-6510

Titanium / conjunctiva forceps / longitudinally serrated jaws / with cross serrations at tips / straight

T14-6500 1.2 mm tip  
T14-6510 1.7 mm tip



T14-6510

**Barraquer Cilia Forceps**

TC Dust / slightly angled

14-6303



14-6303

Titanium / TC dust / slightly angled

T14-6303



T14-6303

**Gradle Cilia Forceps**

Smooth square jaws

14-6400  
T14-6400 titanium

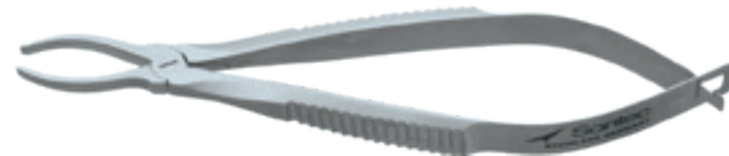

14-6400



T14-6400

**Cilia Forceps**

Smooth jaws / polished finish / serrated handle / narrow

14-6415



14-6415

**Ziegler Cilia Forceps**

TC Dust / straight

14-6450



14-6450

**Bergh Cilia Forceps**

5 mm wide jaws with horizontal serrations / 3 1/2" (9 cm)

14-6445



14-6445

**Beer Distichia Cilia Forceps**

5 mm wide jaws with TC Dust / 3 3/4" (9.5 cm)

1100-407



1100-407

**Swiss Cilia Forceps**

3mm platform tip / TC Dust

14-6310



14-6310

**Knapp Trachoma Forceps**

With rollers

14-9930



14-9930

**Kelman-McPherson 1x2 Tissue Forceps**

8 mm long / 0.3 mm / angled / 1 x 2 box teeth  
14-2630

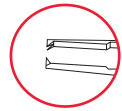

14-2630

**Stern-Castroviejo Suture 1x2 Tissue Forceps**

6 mm long / 1 x 2 box teeth / 0.5 mm / straight / handle with thumb catch lock  
14-2890

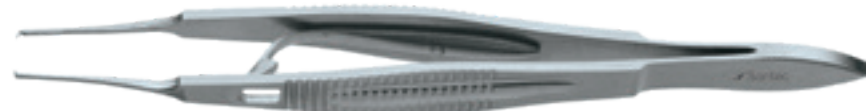
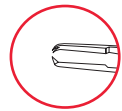

14-2890

**Manhattan 1x2 Tissue Forceps**

Tying platform / 1 x 2 box teeth / stainless

14-3050 0.7 mm  
14-3070 0.6 mm  
14-3060 0.3 mm

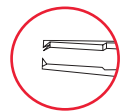

14-3070

Tying platform / 1 x 2 box teeth / titanium

T14-3050 0.7 mm  
T14-3070 0.6 mm  
T14-3060 0.3 mm

**Manhattan Severin 1x2 Tissue Forceps**

Tying platform / 1 x 2 angled teeth / stainless

14-3073 0.12 mm delicate  
14-3075 0.3 mm  
14-3071 0.5 mm  
14-3072 0.6 mm  
14-3077 0.7 mm

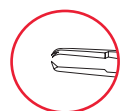

14-3077

Tying platform / 1 x 2 angled teeth / titanium

T14-3073 0.12 mm delicate  
T14-3075 0.3 mm  
T14-3071 0.5 mm  
T14-3072 0.6 mm  
T14-3077 0.7 mm

**Bracken 1x2 Fixation Forceps**

1 x 2 teeth / angled / 4 1/4" (10.5 cm)  
14-4800

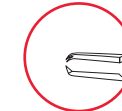

14-4800

**Lester Fixation 1x2 Tissue Forceps**

4" (10 cm)  
14-4600 1 x 2 teeth  
14-4620 2 x 3 teeth

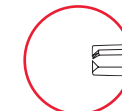

14-4620

**Girard 1x2 Fixation Forceps**

With sliding lock / 1 x 2 angled teeth

14-3240 0.3 mm  
14-3245 0.9 mm  
14-3246 0.5 mm

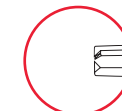

14-3240

With sliding lock / 0.5 mm / curved / with tying platform / 1 x 2 angled teeth

14-3247



14-3245



14-3247

**Strabismus Forceps**

1x2 teeth / slide lock

14-3150 straight  
14-3152 right  
14-3154 left



14-3150



14-3152



14-3154

**Girard 1x2 Fixation Forceps**

With push lock / 1 x 2 box teeth

14-3260A 0.3 mm  
14-3260B 0.5 mm  
14-3260C 0.9 mm  
14-3260D 1.2 mm

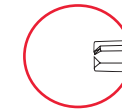



**Girard Corneoscleral Forceps**

Tying platform / 1 x 2 angled teeth / 0.12 mm / delicate

- 14-3200 right handed
- 14-3210 left handed



14-3200

**Hyde Corneal Forceps**

Tying platform / 2 x 2 box teeth / 0.12 mm / delicate

- T14-2220
- 14-2220

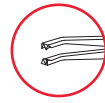

14-2220

**Bishop-Harmon 1x2 Tissue Forceps Titanium**

1 x 2 box teeth / 3 1/2" (9 cm)

- T14-3803 0.3 mm
- T14-3805 0.5 mm
- T14-3810 0.8 mm



T14-3810

**Bishop-Harmon 1x2 Tissue Forceps**

1 x 2 teeth / 3 1/2" (9 cm)

- 14-3800 0.3 mm tip delicate
- 14-3805 0.5 mm tip
- 14-3810 0.8 mm tip



14-3810

**Castroviejo Suture 1x2 Teeth Forceps**

With tying platform / 1 x 2 teeth / stainless

- 14-2800 0.12 mm tip
- 14-2805 0.2 mm tip
- 14-2810 0.3 mm tip
- 14-2860 0.3 mm tip angled tips on flat
- 14-2815 0.4 mm tip
- 14-2820 0.5 mm tip
- 14-2880 0.5 mm tip angled tips on flat
- 14-2830 0.9 mm tip
- 14-2840 1.5 mm tip



14-2810

With tying platform / 1 x 2 teeth / titanium

- T14-2800 0.12 mm tip
- T14-2805 0.2 mm tip
- T14-2810 0.3 mm tip
- T14-2815 0.4 mm tip
- T14-2820 0.5 mm tip
- T14-2830 0.9 mm tip
- T14-2840 1.5 mm tip



T14-2810

**Troutman-Colibri Suture Forceps**

Tying platform / 1 x 2 box teeth / 0.12 mm / ergonomic handle

- 14-2955



14-2955

**Kelman & Hoffer Suture Tissue Forceps**

Angled / tying platform / 1 x 2 box teeth / 0.12 mm / ergonomic handle

- 14-2935



14-2935

**Ergonomic-Handle Castroviejo Suture Forceps**

Straight / tying platform / 1 x 2 angled teeth / 0.12 mm / 4 1/2" (11.5 cm)

- 14-2905



14-2905

**Ergonomic-Handle Bonn Suture Forceps**

Long tip / Tying platform / 1 x 2 box teeth / 0.12 mm / 4 1/2" (11.5 cm)

- 14-2920

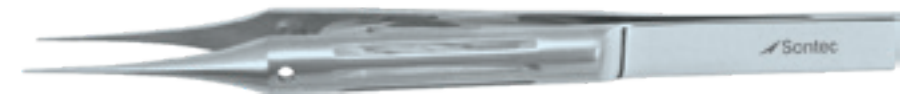

14-2920

Short tip / tying platform / 1 x 2 box teeth / 0.12 mm / 4 1/2" (11.5 cm)

- 14-2922



14-2922

**Pierse Corneal 1x2 Forceps**

Very delicate / micro grooved tips

- 14-2100 straight
- 14-2110 curved



14-2100

**Bonney Tissue Forceps**

**Serrated / 6 3/4" (17 cm)**

140-502 1 x 2 teeth TC serrated  
136-578 2 x 3 teeth serrated

**1 x 2 / 7" (18 cm)**

136-580 serrated  
140-500 TC serrated

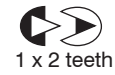

1 x 2 teeth



2 x 3 teeth



140-502



136-578



136-580

**Cushing Tying Forceps**

**Standard / straight tip / 7" (18 cm)**

2200-789 serrated  
2200-790 1x2 teeth



2200-789

**TC insert platform / straight tip**

2200-383 7" (18 cm)



2200-383

**TC insert platform / 7" (18 cm)**

2200-387 angled tip  
2200-389 straight tip 1x2 teeth

**TC insert platform / straight tip / serrated**

2200-394 8 1/4" (21 cm)  
2200-396 10" (25 cm)



Straight



Angled

**Potts-Smith Dressing**

**Serrated**

136-730 7" (18 cm)  
136-735 8 1/4" (21 cm)  
136-740 9 1/2" (24 cm)  
136-746 12" (30 cm)



136-740

**Potts-Smith Tissue Forceps**

Serrated / 1 x 2 teeth

- 136-732 7" (18 cm)
- 136-737 8 1/4" (21 cm)
- 136-742 9 1/2" (24 cm)
- 136-748 12" (30 cm)



136-737

**Reul Coronary Artery Forceps**

TC serrated / 1 mm / 8" (20 cm)

2200-126



2200-126

**Skinner Tissue Forceps**

1 x 2 teeth / TC platform / 8" (20.5 cm)

- 140-517M micro
- 140-517 delicate
- 140-517G standard



1 x 2 teeth / TC platform / 9" (23 cm)

- 140-379 micro
- 140-378 delicate
- 140-376 standard

1 x 2 teeth / TC platform / 10" (25.5 cm)

- 140-519M micro
- 140-519 delicate
- 140-519G standard



140-376

**Lucae Ear Forceps**

Bayonet handle / serrated

- 467-310 4 1/2" (11.5 cm)
- 467-311 5 1/2" (14 cm)



467-310

**Brown-Cushing Bayonet Forceps**

9 x 9 teeth / 7 1/4" (18.25 cm)

136-798



136-798

**Gruenwald (Jansen) Ear Forceps**

Bayonet handle / serrated

- 467-315 6 1/2" (16.5 cm)
- 467-317 7 3/4" (19.5 cm)
- 467-318 8 1/2" (21.5 cm)



467-315



467-317



467-318

**Cushing Bayonet Forceps**

TC / serrated / 7 1/2" (19 cm)

140-220



140-220

**Electro Blue Coated Skinner Tissue Forceps**

Monopolar use / TC serrated platform / 1 x 2 teeth / insulated / 9" (22.9 cm)

140-376B



140-376B

**Electro Blue Coated Cushing Bayonet Tissue Forceps**

Monopolar use / TC serrated/insulated

140-220B 7 1/2"

140-222B 9"



140-220B

**Electro Blue Coated Potts-Smith Tissue Forceps**

Monopolar use / TC Platform / insulated / 2.5 mm tip / flat handle / 9 1/4" (23.5 cm)

2200-073B straight

2200-074B angled



2200-073B



2200-074B

**DeBakey Tissue Forceps**

**Flat handle / 6" (15 cm)**

- 2200-101 1.0 mm tip
- 2200-101A 1.5 mm tip
- 2200-105 2.0 mm tip
- 2200-105A 2.5 mm tip
- 2200-105B 2.8 mm tip

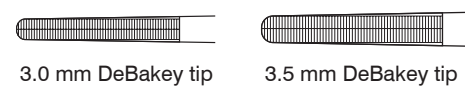
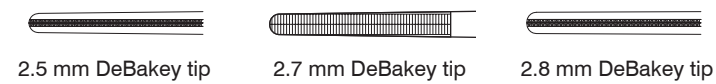

**Flat handle / 7 3/4" (19.5 cm)**

- 2200-102 1.0 mm tip
- 2200-102A 1.5 mm tip
- 2200-107 2.0 mm tip
- 2200-110 2.7 mm tip
- 2200-112 3.5 mm tip

**Flat handle / 9 1/2" (24 cm)**

- 2200-103 1.5 mm tip
- 2200-108 2.0 mm tip
- 2200-111 2.7 mm tip
- 2200-1133 3.0 mm tip
- 2200-113 3.5 mm tip

**Flat handle / 12" (30 cm)**

- 2200-104 1.5 mm tip
- 2200-109 2.0 mm tip
- 2200-1112 2.7 mm tip
- 2200-1132 3.5 mm tip

**With pin / flat handle / 7 3/4" (19.5 cm)**

- 2200-107P 2.0 mm tip
- 2200-110P 2.7 mm tip

**With pin / flat handle / 9 1/2" (24 cm)**

- 2200-108P 2.0 mm tip
- 2200-111P 2.7 mm tip

**With pin / flat handle / 12" (30 cm)**

- 2200-1112P 2.7 mm tip

\* other sizes available with pin upon request.



2200-105



2200-110P



2200-111P

**Barraquer Cilia Forceps**

**TC Dust / slightly angled**

14-6303

**Titanium / TC dust / slightly angled**

T14-6303



14-6303



T14-6303

**Iris 1x2 Tissue Forceps**

**1 x 2 teeth / 0.5 mm tip / extra delicate / 4" (10 cm)**

- 14-4400 straight
- 14-4410 half curve
- 14-4415 full curve



14-4440

**1 x 2 teeth / 0.8 mm tip / standard / 4" (10 cm)**

- 14-4440 straight
- 14-4450 half curve
- 14-4455 full curve

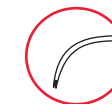
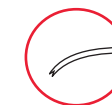

**Castroviejo Suture 1x2 Teeth Forceps**

With tying platform / 1 x 2 teeth / stainless

- 14-2800 0.12 mm tip
- 14-2805 0.2 mm tip
- 14-2810 0.3 mm tip
- 14-2860 0.3 mm tip angled tips on flat
- 14-2815 0.4 mm tip
- 14-2820 0.5 mm tip
- 14-2880 0.5 mm tip angled tips on flat
- 14-2830 0.9 mm tip
- 14-2840 1.5 mm tip



14-2810

With tying platform / 1 x 2 teeth / titanium

- T14-2800 0.12 mm tip
- T14-2805 0.2 mm tip
- T14-2810 0.3 mm tip
- T14-2815 0.4 mm tip
- T14-2820 0.5 mm tip
- T14-2830 0.9 mm tip
- T14-2840 1.5 mm tip



T14-2810

**Cushing Bipolar Forceps**

Black insulated / non-stick / 1.5 mm tip / 7" (18 cm)

2700-995NS



**Tissue Bipolar Forceps**

Black insulated / non-stick / 2.0 mm tip / 6" (15 cm)

- 2700-862NS
- 2700-864NS with stop pin



2700-862NS



2700-864NS

**Jewelers Bipolar Forceps**

0.4 mm tip / 4" (10 cm)

- 2700-920 straight
- 2700-922 curved
- 2700-915 straight blue coat



2700-920



2700-915

Insulated / non-stick / straight / 4 1/4" (10.8 cm)

- 2700-924NS 0.5 mm



2700-924NS

**McPherson Bipolar Forceps**

Smooth tying platform / 0.4 mm tip / 3 1/2" (9 cm)

- 16-2700 straight
- 16-2710 angled



16-2700



16-2710

**Adson Bipolar Forceps**

1 mm tip / 4 3/4" (12 cm)

- 2700-905
- 2700-900 blue electro coat
- 2700-902 4mm angled tip blue electro coat



2700-900



2700-902

1 mm tip / fenestrated handle / 4 3/4" (12 cm)

- 2700-902F 4 mm angled tip blue electro coat
- 2700-906 pointed tips



2700-902F

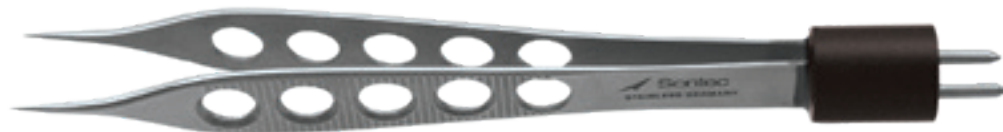

2700-906

1 mm tip / fenestrated handle / non-stick / black coated / 4 3/4" (12 cm)

- 2700-908NS straight
- 2700-903NS angled



2700-908NS

**Cushing Bayonet Bipolar Forceps**

Stainless steel / 7 1/2" (19 cm)

- 2700-978 0.7 mm tip
- 2700-940 2.0 mm tip insulated



2700-978



2700-940

**Reusable Bipolar Cord**

12 feet in length  
CORD-2000

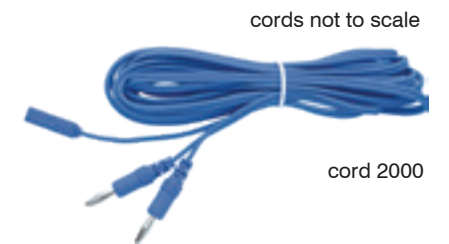

CORD-2000

cord 2000

**Disposable Bipolar Cord**

Sterile-12 ft long / nickle plated banana plugs / forceps plug compatible with all manufacture bipolar forceps and sweeps / packaged 50 per case/ box of 10  
CORD-1000



cord 1000

**Glover-Debakey Bulldog Clamp**

Atraumatic Jaws / straight / spring loaded

- 2100-460 2" (5 cm)
- 2100-459 2 3/4" (7 cm)
- 2100-457 3 3/8" (8 cm)
- 2100-455 5" (12.5 cm)



2100-460



2100-459



2100-460



2100-457



2100-455



2100-460



2100-459

Atraumatic jaws / curved / spring loaded

- 2100-462 2" (5 cm)
- 2100-461 2 3/4" (7 cm)
- 2100-458 3 1/8" (8 cm)
- 2100-456 4 5/8" (11 cm)



2100-462



2100-461



2100-461



2100-458



2100-456



2100-462

**Micro Sontec® Yasargil-Glover Carotid Artery Bulldog Clamp**

Atraumatic jaws / reverse 65° angle / 3" (7.5 cm) / spring loaded

- 2100-466



2100-466

**Laparoscopic Bulldog Clamp**

Curved

- 2901-281-25 25 mm jaw overall length 2"
- 2901-281-40 40 mm jaw overall length 2 1/2"



2901-281-25



2901-281-40



**Cooley Bulldog Clamp**

**Atraumatic jaws / straight / cross-action**

- 2100-420 3 1/8" (8 cm)
- 2100-425 3 1/2" (9 cm)
- 2100-430 4 1/4" (10.75 cm)
- 2100-435 5" (12.5 cm)



2100-430

\* Can be used with Bulldog Clamp Applying Forceps (2100-399) below



2100-420



2100-425



2100-430



2100-435

**Atraumatic jaws / curved / cross-action**

- 2100-422 3" (7.5 cm)
- 2100-427 3 3/8" (8 cm)
- 2100-432 3 3/4" (9.5 cm)
- 2100-437 4 1/2" (11.5 cm)



2100-427



2100-422

2100-427

2100-432

2100-437

Bulldog Clamp Applying Forceps used in conjunction with bulldogs above

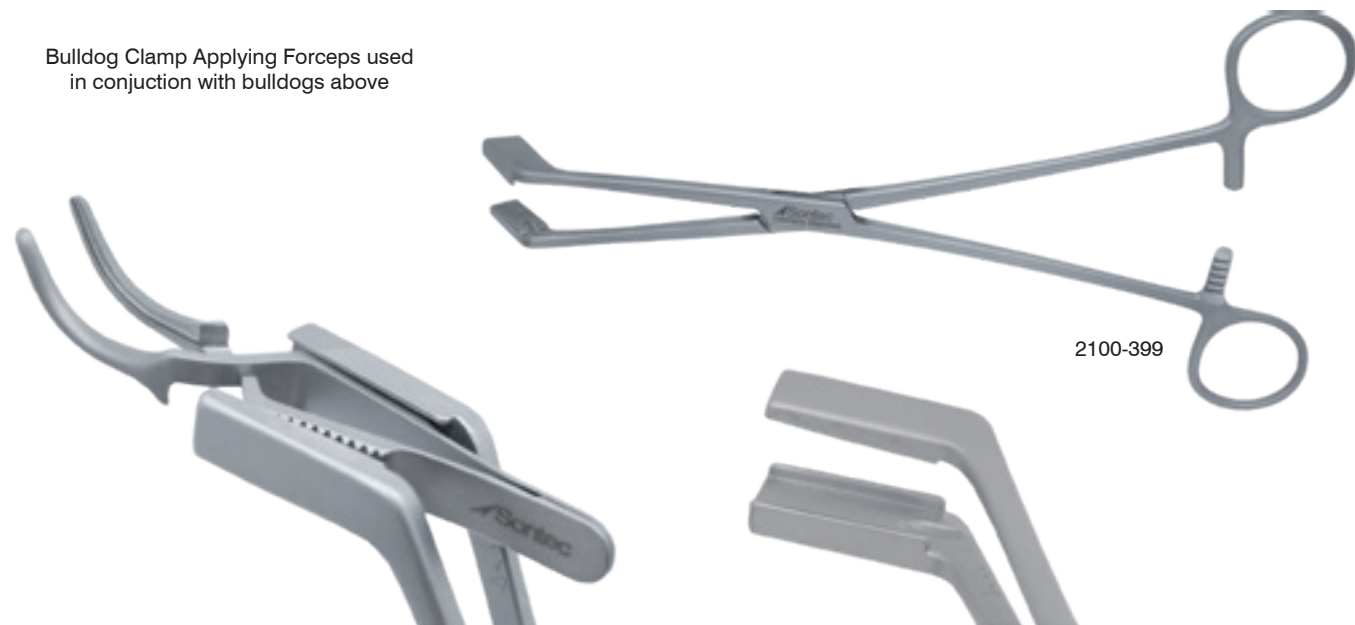

2100-399

**DeBakey Bulldog Clamp**

**Atraumatic Jaws / straight / cross-action**

- 2100-800 3 1/8" (8 cm)
- 2100-802 3 1/2" (9 cm)
- 2100-804 4 1/4" (10.75 cm)
- 2100-806 5" (12.5 cm)



2100-804

\* Can be used with Bulldog Clamp Applying Forceps (2100-399) below



2100-800



2100-802



2100-804



2100-806

**Atraumatic Jaws / curved / cross-action**

- 2100-810 3" (7.5 cm)
- 2100-812 3 1/8" (8 cm)
- 2100-814 3 3/4" (9.5 cm)
- 2100-816 4 1/2" (11.5 cm)



2100-812



2100-810

2100-812

2100-814

2100-816

Bulldog Clamp Applying Forceps used in conjunction with bulldogs above



2100-399

**Dietrich Micro Bulldog Clamp**

Serrated jaw / straight / 2" (5 cm) / cross-action

- 2100-835 8 mm jaw length
- 2100-836 12 mm jaw length
- 2100-837 20 mm jaw length

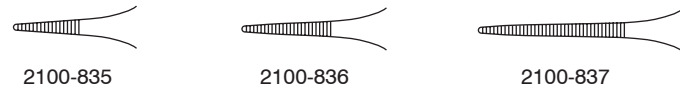

Serrated jaw / angled / 2" (5 cm) / cross-action

- 2100-838 8 mm jaw length
- 2100-839 12 mm jaw length
- 2100-840 20 mm jaw length

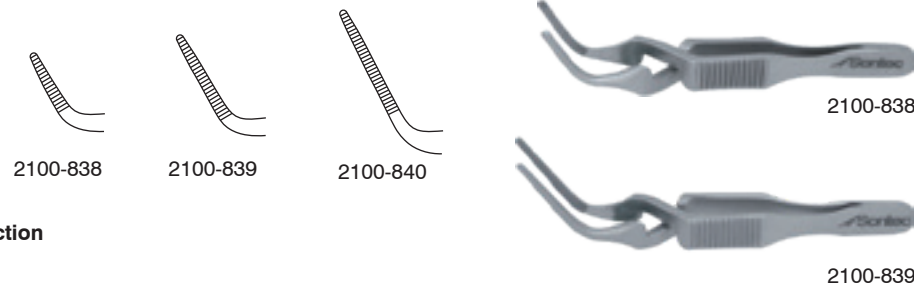

Serrated jaw / curved / 2" (5 cm) / cross-action

- 2100-841 20 mm jaw length

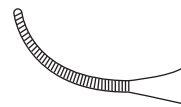

Smooth jaw / angled / 2" (5 cm) / cross-action

- 2100-842 13 mm jaw length
- 2100-843 18 mm jaw length

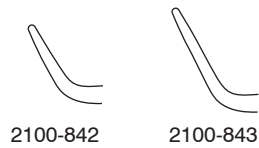

**Universal Microvascular Clamp**

For ordering: use order numbers listed below / also available in black / choose either A for Artery or V for Vein

	Clamp #1	Clamp #2	Clamp #3	Clamp #4	Clamp #5
<b>Length</b>	8 mm	11 mm	16 mm	24 mm	35 mm
<b>Pair of Clamps</b>					
<b>Vessel</b>	0.3-1.0 mm	0.6-1.5 mm	1.0-2.5 mm	1.5-3.3 mm	2.0-5.0 mm
<b>Designation</b>	B-1	B-2	B-3	HD-S	RD-S
<b>Order Number</b>	2100-B-1A 2100-B-1V	2100-B-2A 2100-B-2V	2100-B-3A 2100-B-3V	2100-HD-SA 2100-HD-SV	2100-RD-SA 2100-RD-SV

**Microvascular Clamp**

For ordering: use order numbers listed below / also available in black / choose either A for Artery or V for Vein

	Clamp #1	Clamp #2	Clamp #3	Clamp #4	Clamp #5
<b>Length</b>	8 mm	11 mm	16 mm	24 mm	35 mm
<b>Microvascular clamp pair on approximator bar</b>					
<b>Vessel</b>	0.3-1.0 mm	0.6-1.4 mm	1.0-2.25 mm	1.5-3.5 mm	2.0-5.0 mm
<b>Designation</b>	ABB-11	ABB-22	ABB-33	HD-D	RD-D
<b>Order Number</b>	2100-ABB-11A 2100-ABB-11V	2100-ABB-22A 2100-ABB-22V	2100-ABB-33A 2100-ABB-33V	2100-HD-DA 2100-HD-DV	2100-RD-DA 2100-RD-DV
<b>Microvascular clamp pair on approximator bar in frame</b>				<div style="border: 1px solid black; padding: 5px; width: fit-content; margin: auto;">                     All Microvascular Clamps are available in black. To order black clamps, please add a "B" after the order number                 </div>	
<b>Vessel</b>	0.4-1.0 mm	0.6-1.4mm	1.0-2.2 mm		
<b>Designation</b>	ABB-1	ABB-2	ABB-3		
<b>Order Number</b>	2100-ABB-1A 2100-ABB-1V	2100-ABB-2A 2100-ABB-2V	2100-ABB-3A 2100-ABB-3V		
<b>Microvascular clamp pair in wire frame</b>					
<b>Vessel</b>	0.3-1.0 mm	0.6-1.4 mm	1.0-2.2 mm		
<b>Designation</b>	DC-1	DC-2	DC-3		
<b>Order Number</b>	2100-DC-1A 2100-DC-1V	2100-DC-2A 2100-DC-2V	2100-DC-3A 2100-DC-3V		
<b>Microvascular clamp pair DC Angle</b>					
<b>Vessel</b>	0.3-1.0 mm	0.6-1.4 mm	1.0-2.2 mm		
<b>Designation</b>	DC-1	DC-2	DC-3		
<b>Order Number</b>	2100-DC-1A 2100-DC-1V	2100-DC-2A 2100-DC-2V	2100-DC-3A 2100-DC-3V		

**Micro Aneurysm Clamp Applier Forceps**

- 5 1/2" (14 cm)
- 2100-875



**Serrefine Bulldog Clamp**

**1 1/2" (4 cm) / cross-action**

- 14-9935 straight
- 14-9940 curved

**2 1/2" (6.4 cm) / cross-action**

- 115-585 straight
- 115-586 curved



**John Hopkins Bulldog Clamp**

**Straight / cross-action**

- 440-352 1 1/2"
- 440-354 2"
- 440-356 2 1/4"
- 440-358 2 1/2"
- 440-360 2 3/4"
- 440-362 3"
- 440-364 3 1/2"

**Curved / cross-action**

- 440-370 1 1/2"
- 440-372 2"
- 440-374 2 1/4"
- 440-376 2 1/2"
- 440-378 2 3/4"
- 440-380 3"
- 440-382 3 1/2"

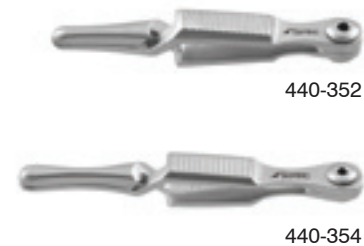

**Cooley and Debakey Neonatal Cardiovascular Clamp**

Especially developed for delicate cardiovascular and neonatal surgery / Ultra fine Cooley and Debakey jaws are atraumatic and provide a secure grip to even the most delicate vessels / 72 varieties available - choose a handle style (by letter) and tip style (by number) / 12 cm / 4 3/4" overall length

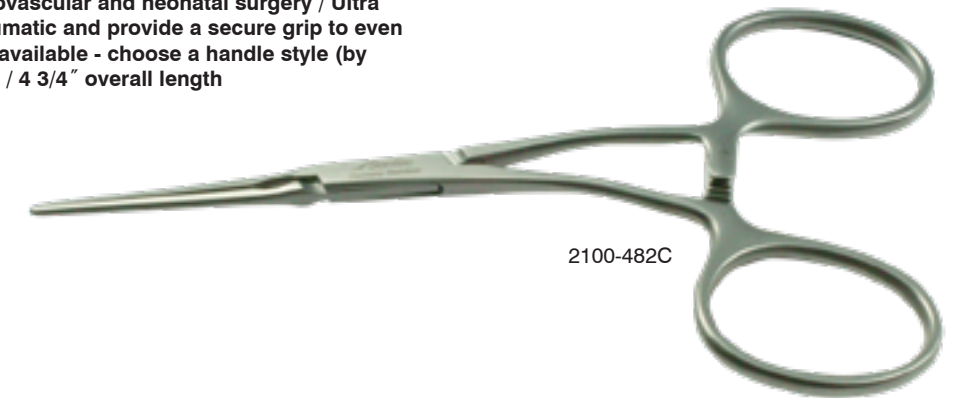

2100-482C

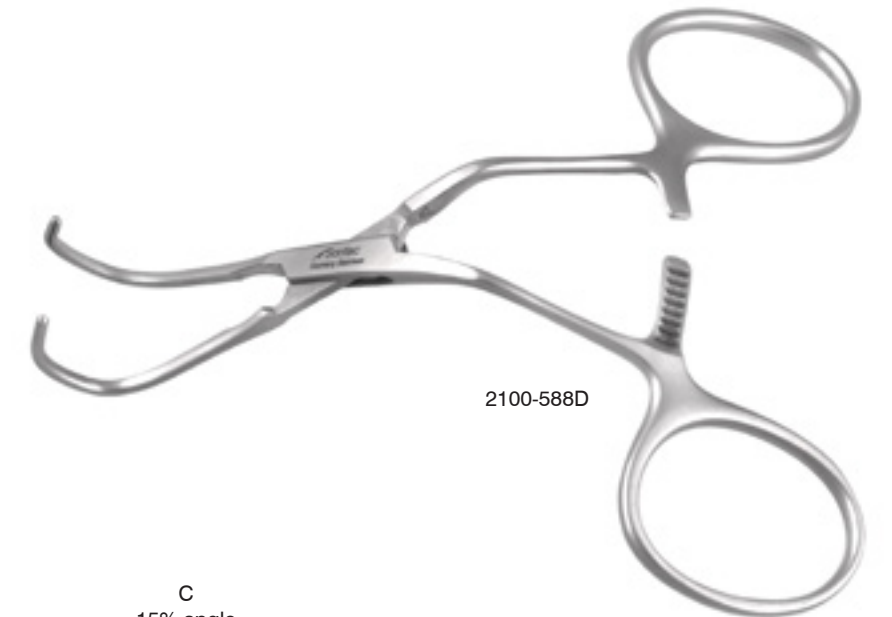

2100-588D

A straight

B curved

C 15% angle

D 45% angle



**Halstead Mosquito Forceps**

**Standard / 6 1/4" (15.5 cm)**

115-408 curved



**Standard / 8 1/4" (21 cm)**

115-400 straight  
115-402 curved  
115-404 right angled

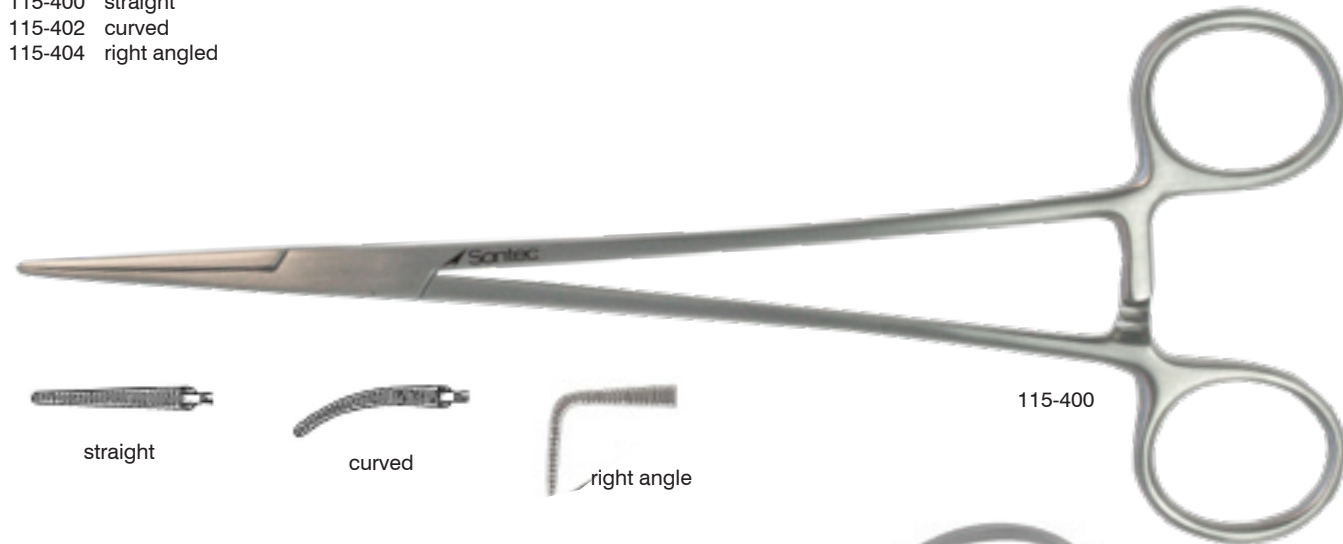

**Delicate / 5" (13 cm)**

115-410D straight  
115-412D curved

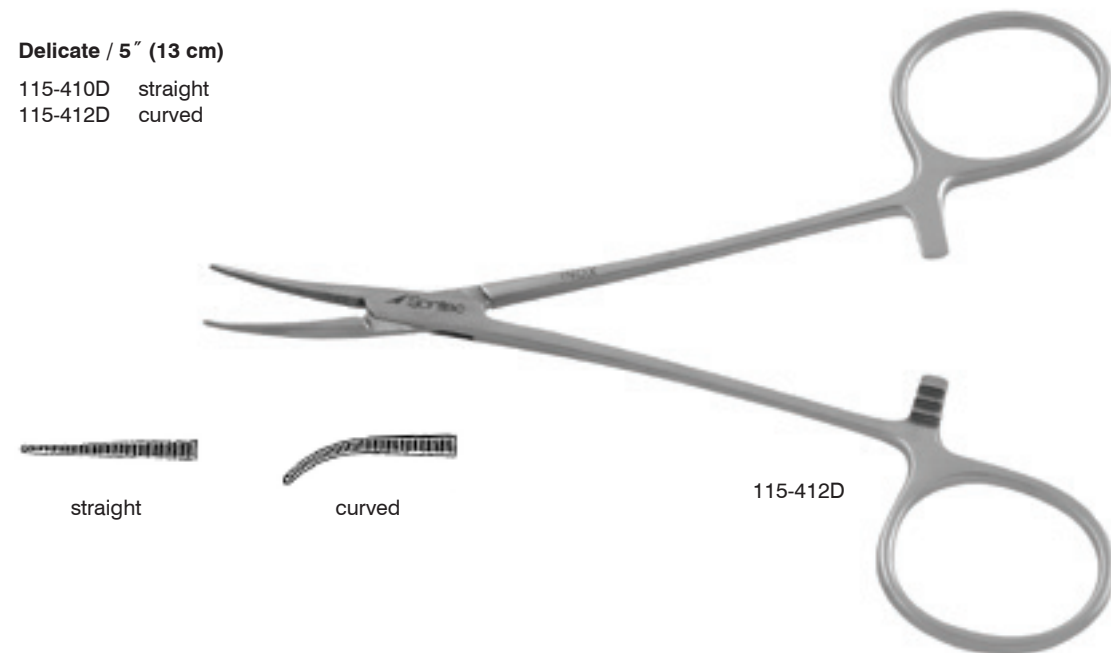

**Hartman Mosquito Forceps**

**Delicate / 3 1/2" (9 cm)**

115-426D straight  
115-428D curved

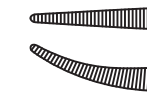

**Standard / 3 1/2" (9 cm)**

115-426 straight  
115-428 curved

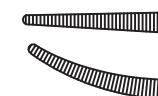

**Delicate / 4" (10 cm)**

115-425D straight  
115-427D curved

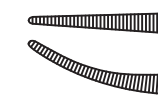

**Shank angled on flat / straight/ 3 1/2" (9cm)**

115-429



straight

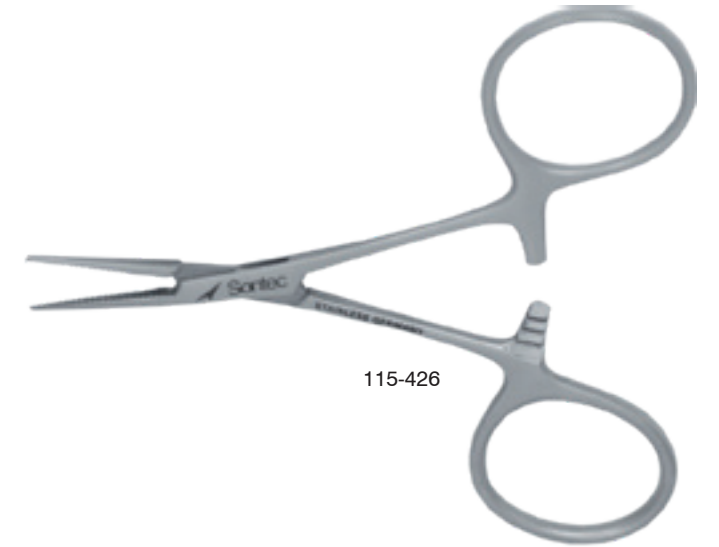

**Halstead Mosquito Forceps**

**Standard / 1 x 2 teeth / 5" (13 cm)**

115-422 straight  
115-424 curved



1 x 2 teeth  
straight



1 x 2 teeth  
curved

**Specially tapered jaws / straight / 1 x 2 micro teeth / 5" (13 cm)**

115-422M



**Kelly Forceps**

5 1/2" (14 cm)

- 115-446 straight
- 115-448 curved
- 115-448L curved left handed

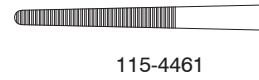

115-4461



115-448

Blue electro coated / 5 1/2" (14 cm)

- 115-4461 straight
- 115-4481 curved



115-446

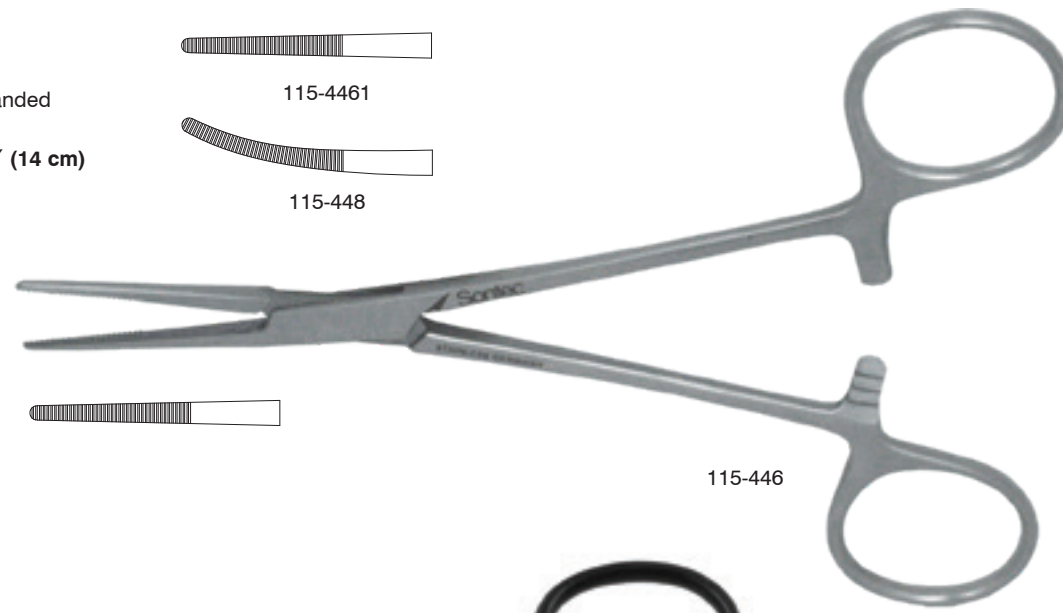

115-448L

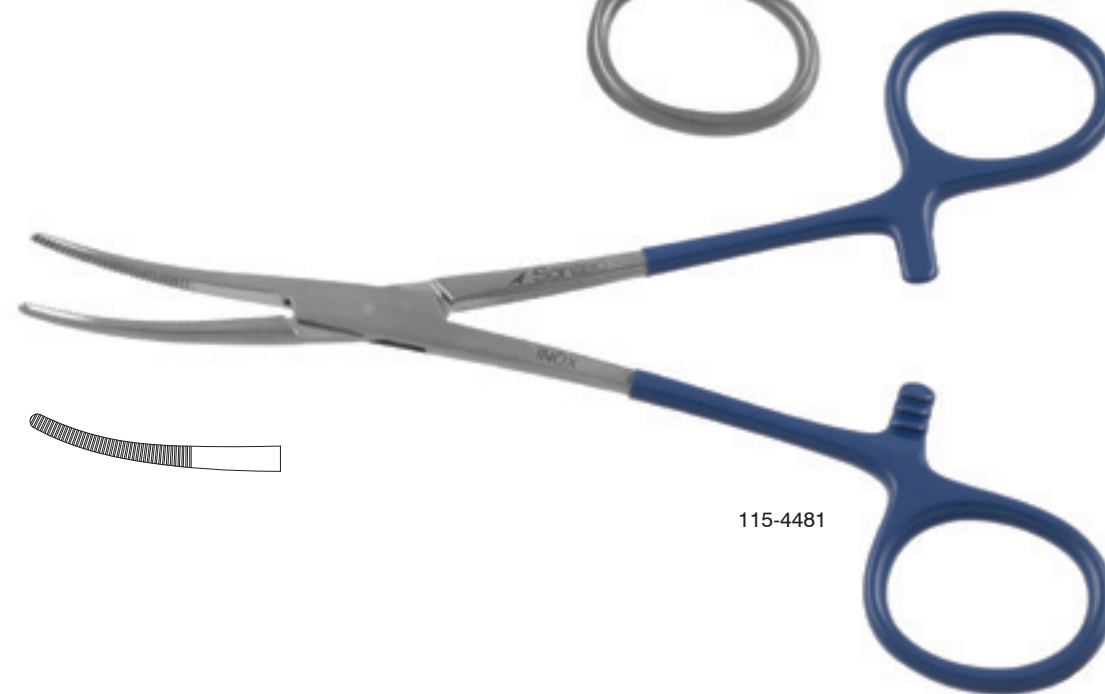

115-4481

**Hartman Micro Tip Mosquito Forceps**

3 1/2" (8.9 cm)

- 115-310 straight
- 115-312 curved



straight



curved

4 3/4" (12cm)

- 115-316 straight
- 115-318 curved

6" (15 cm)

- 115-320 straight
- 115-322 curved

7 1/8" (18 cm)

- 412-319 straight
- 412-321 curved



115-318

**Rochester-Ochsner Forceps**

Serrated / 1 x 2 teeth / 6 1/4" (16 cm)

- 115-520 straight
- 115-522 curved



straight

Serrated / 1 x 2 teeth / 7 1/4" (18.5 cm)

- 115-524 straight
- 115-526 curved



curved

Serrated / 1 x 2 teeth / 8" (20 cm)

- 115-530 straight
- 115-532 curved

Serrated / 1 x 2 teeth / 9" (23 cm)

- 115-534 straight
- 115-536 curved

Serrated / 1 x 2 teeth / 10" (25 cm)

- 115-538 straight
- 115-540 curved

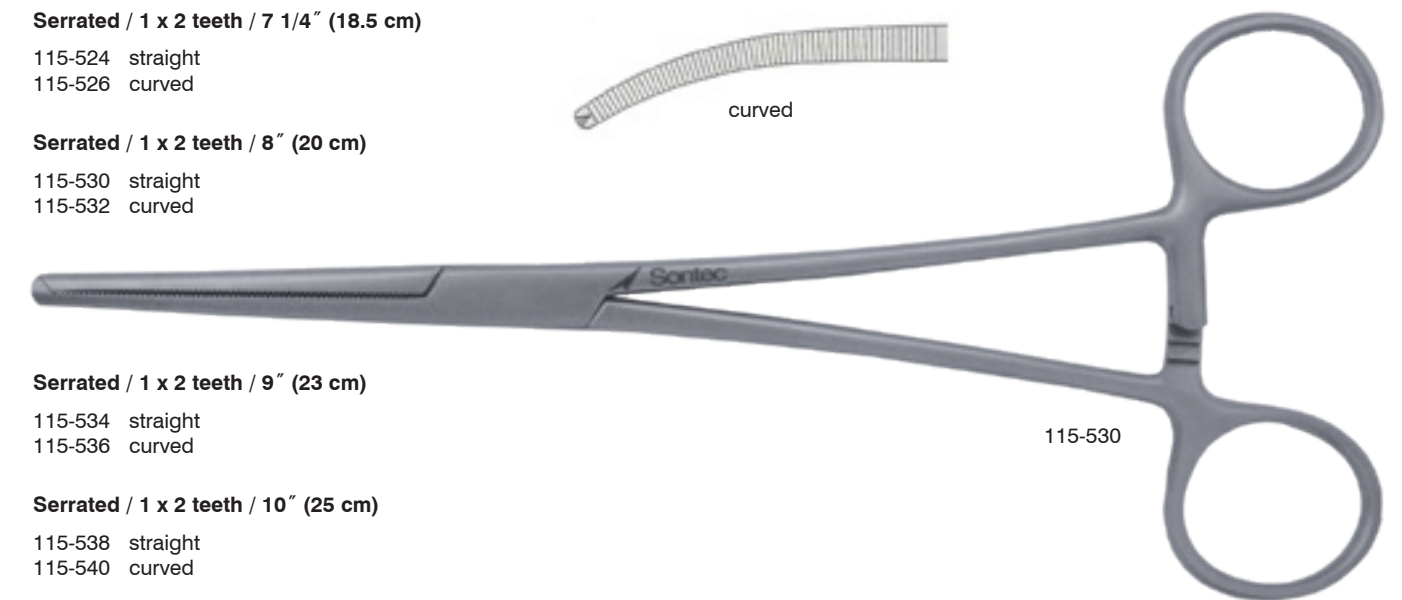

115-530

**Crile Forceps**

5 1/2" (14 cm)

- 115-432 straight
- 115-434 curved

6 1/4" (16 cm)

- 115-450 straight
- 115-452 curved

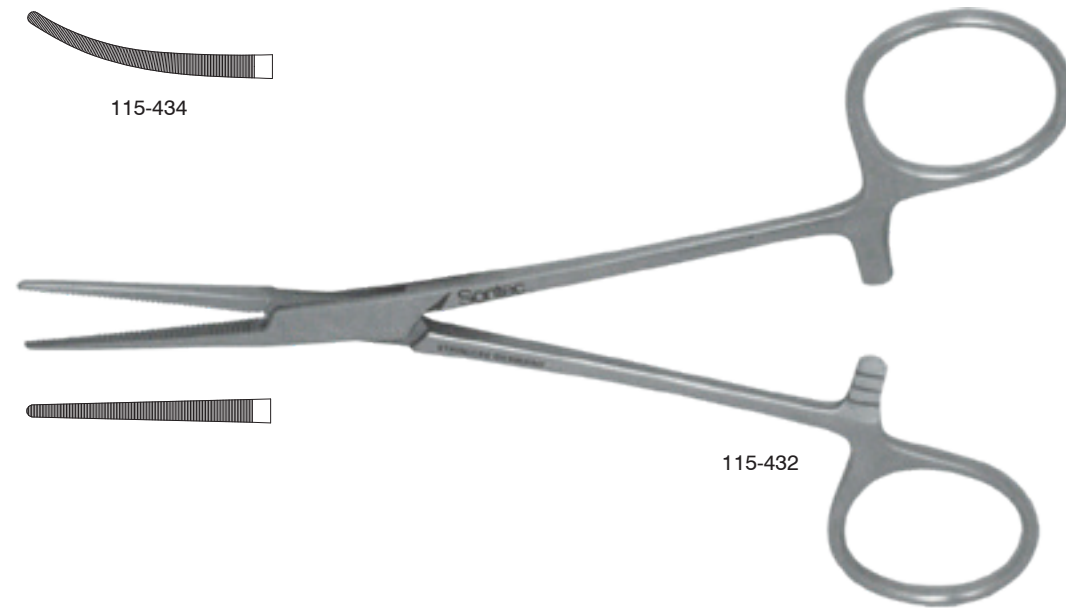
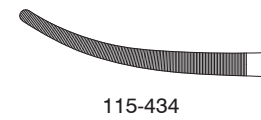

**Titanium / 6 1/4" (16 cm)**

- T115-452 curved
- T115-450 straight



**Adson Forceps**

7 1/2" (19 cm)

- 2200-422 straight jaw
- 2200-424 curved jaw
- 2200-426 full curved jaw

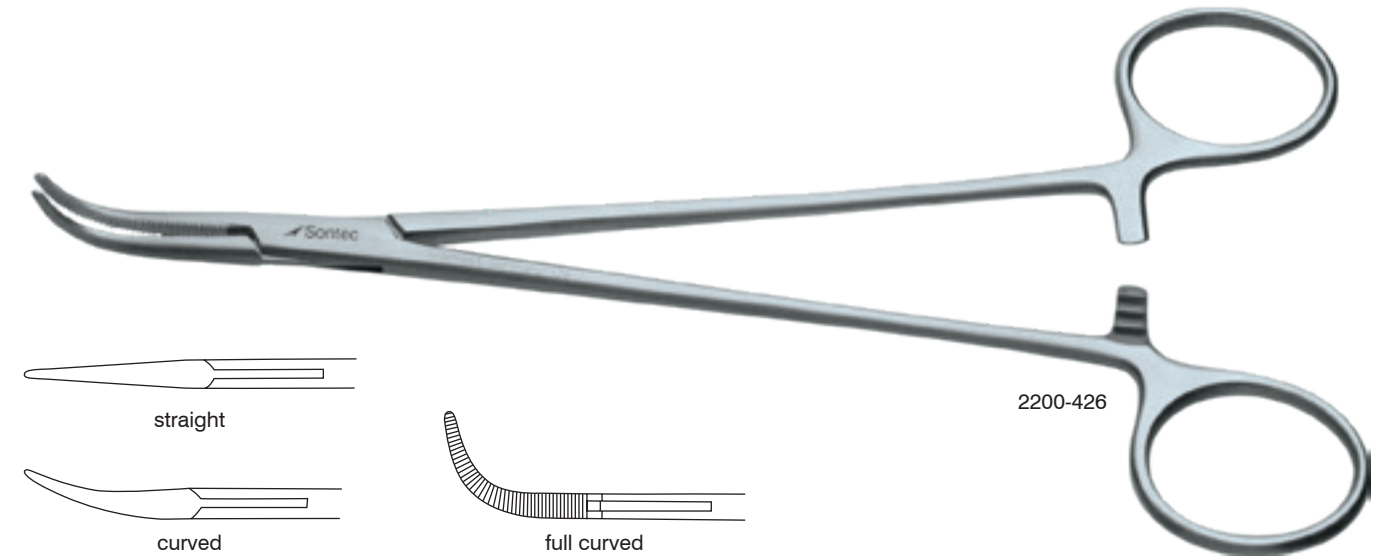

**Schmidt Hemostatic Forceps**

**Serrated / 7 1/2" (19cm)**

- 485-634 slight curve
- 485-636 curved
- 485-646 slight curve closed ring
- 485-648 curved closed ring

**Serrated / 11" (28 cm)**

- 438-591 straight closed ring
- 438-592 slight curve closed ring

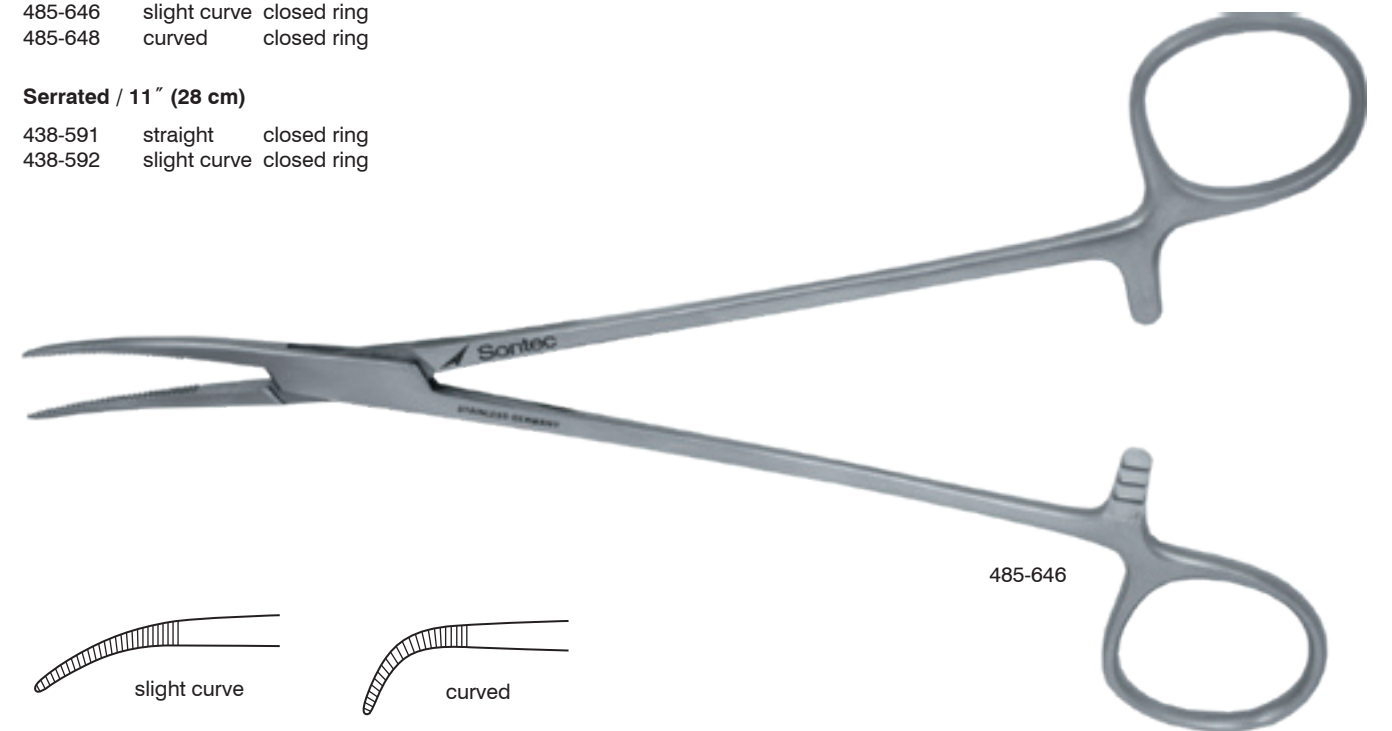

**Lahey Vulsellum Forceps**

150-240 6"  
150-2408 8"

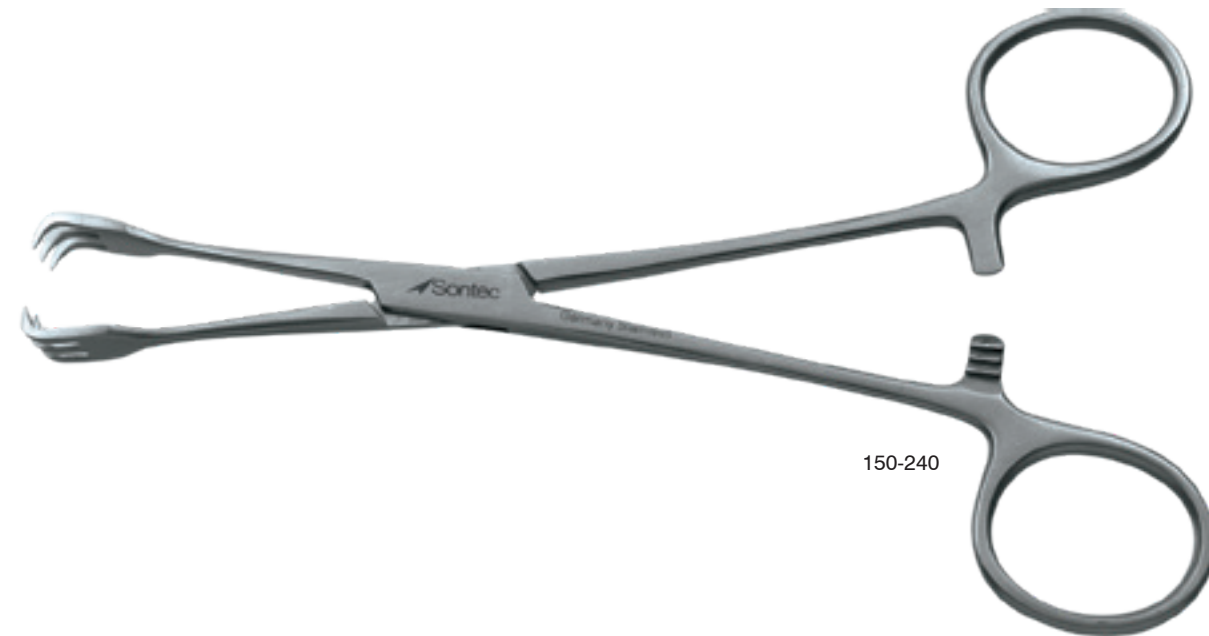

150-240

**Pitanguy Abdomen Marking Forceps**

11" (28 cm)  
475-840

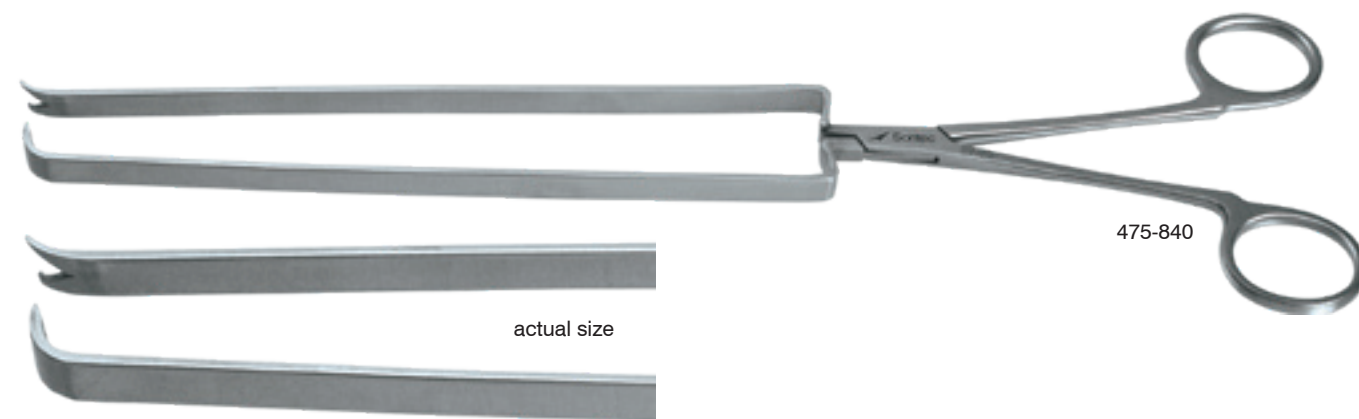

475-840

actual size

**D'assumpcoa Face Lift Marker**

6 1/4" (16 cm)  
215-028 with ratchet  
215-029 without ratchet

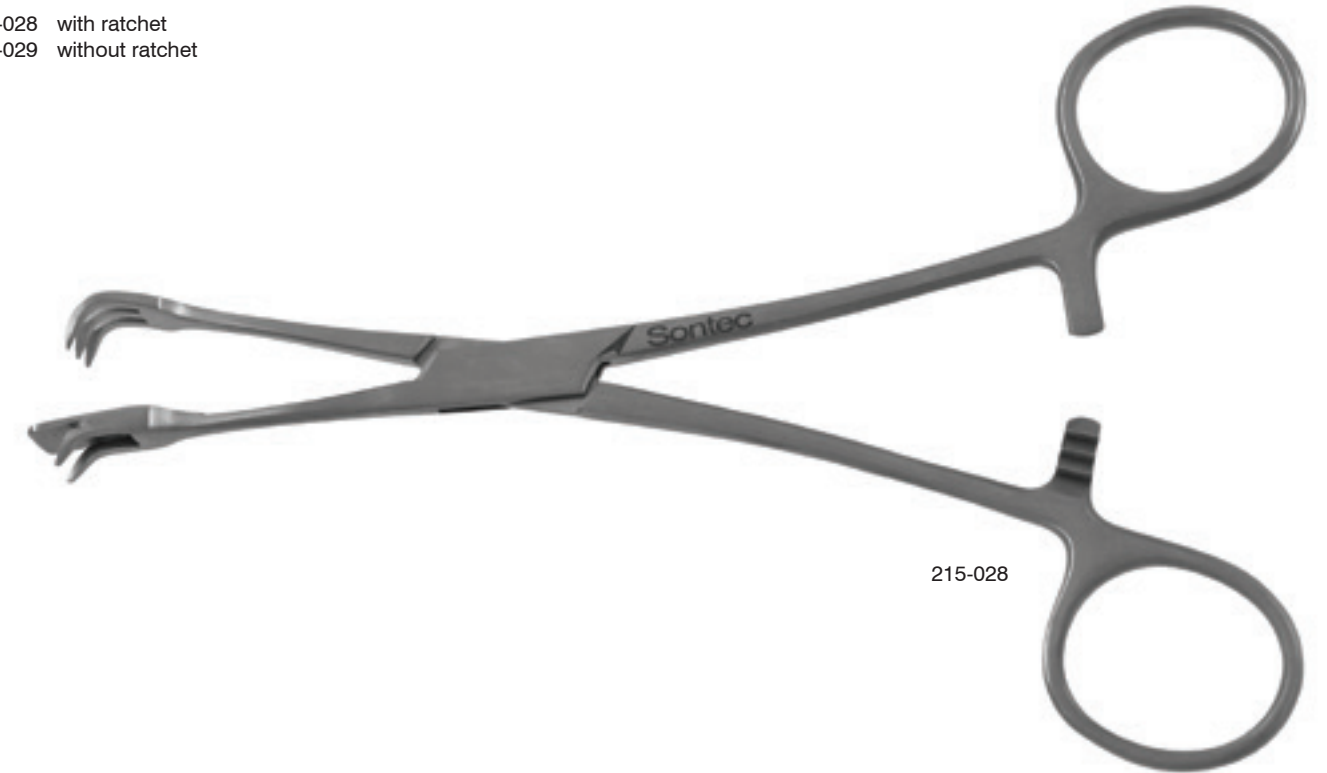

215-028

**Marten Face Lift Marker**

6 3/8" (16 cm)  
215-026 without ratchet  
215-027 with ratchet



215-027

**Pitanguy Marking Forceps**

6 1/2" (17 cm)  
475-846 serrated  
475-847 3 teeth



475-846



475-847

**Pitanguy Abdominal Marking Forceps**

12 1/2" (31.8 cm)  
475-849



475-849

**Tchalekian Mammary Marker Forceps**

11" (28 cm)  
475-842



475-842

**Pitanguy Rhytidoplasty Marking Forceps**

5 1/2" (14 cm)  
475-845



475-845



**Pitanguy Flap Grasping Forceps**

Integrating teeth / 5 1/2" (14 cm)

475-850



475-850

**Aiach-Gubisch Forceps**

6 1/4" (15.9 cm)

115-554



115-554

**Backhaus Towel Forceps**

- 117-500 3 1/2" (9 cm)
- 117-500L 3 1/2" (9 cm) left handed
- T117-500 3 1/2" (9 cm) titanium



117-500



117-500L

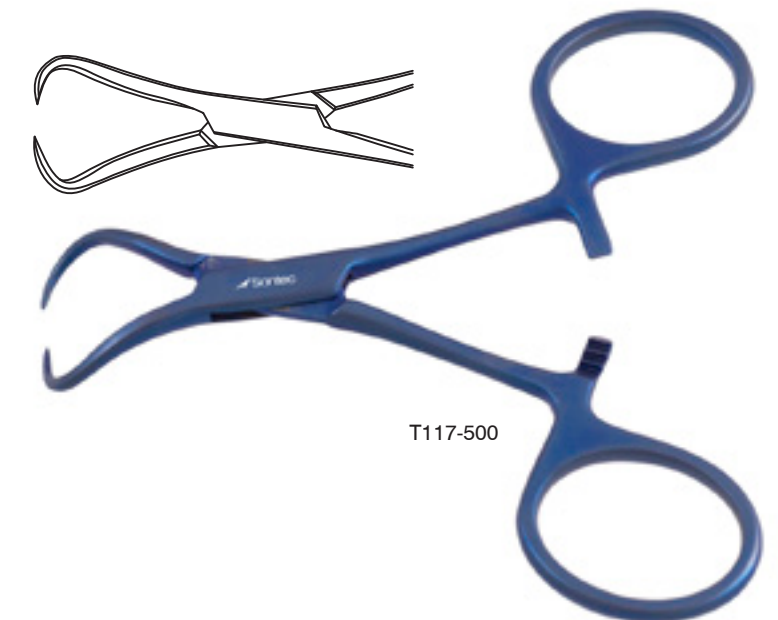

T117-500

**Backhaus Towel Forceps**

117-501 4 1/4" (10.8 cm)  
117-503 5 1/4" (13.5 cm)



117-501

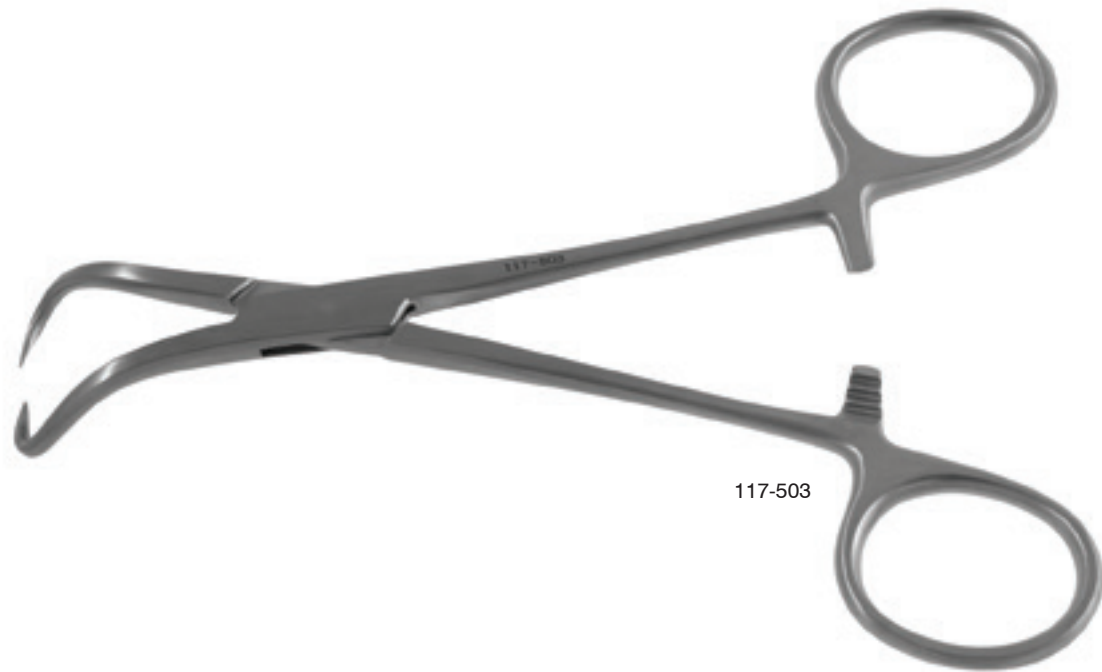

117-503

**Lorna-Edna Towel Forceps**

117-518 4" (10 cm)  
117-521 5 1/2" (14 cm)



117-518



117-521

**Tohoku Towel Forceps**

117-523 5 1/8" (13 cm)

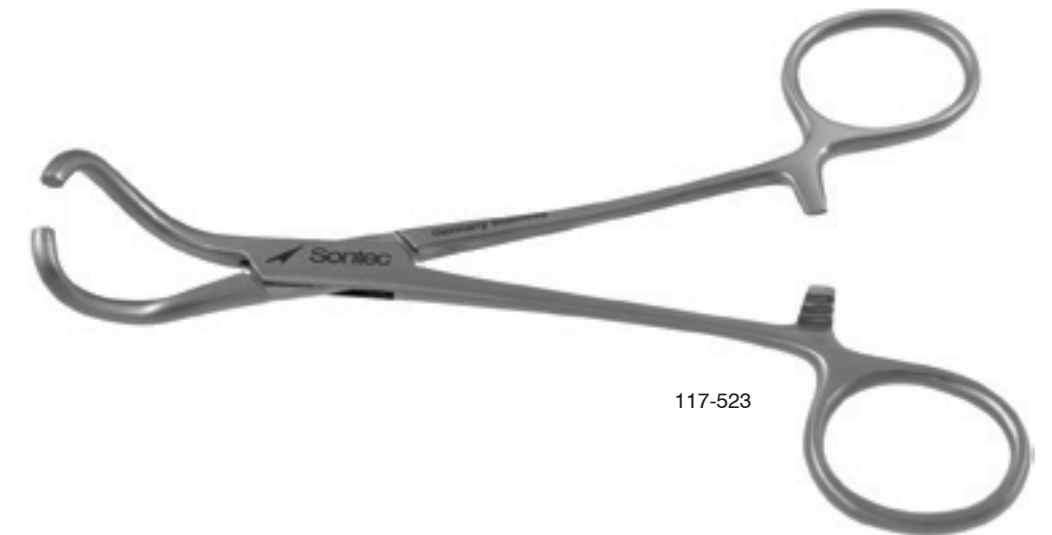

117-523

**Peers Towel Forceps**

5 3/4" (14.6 cm)  
117-524

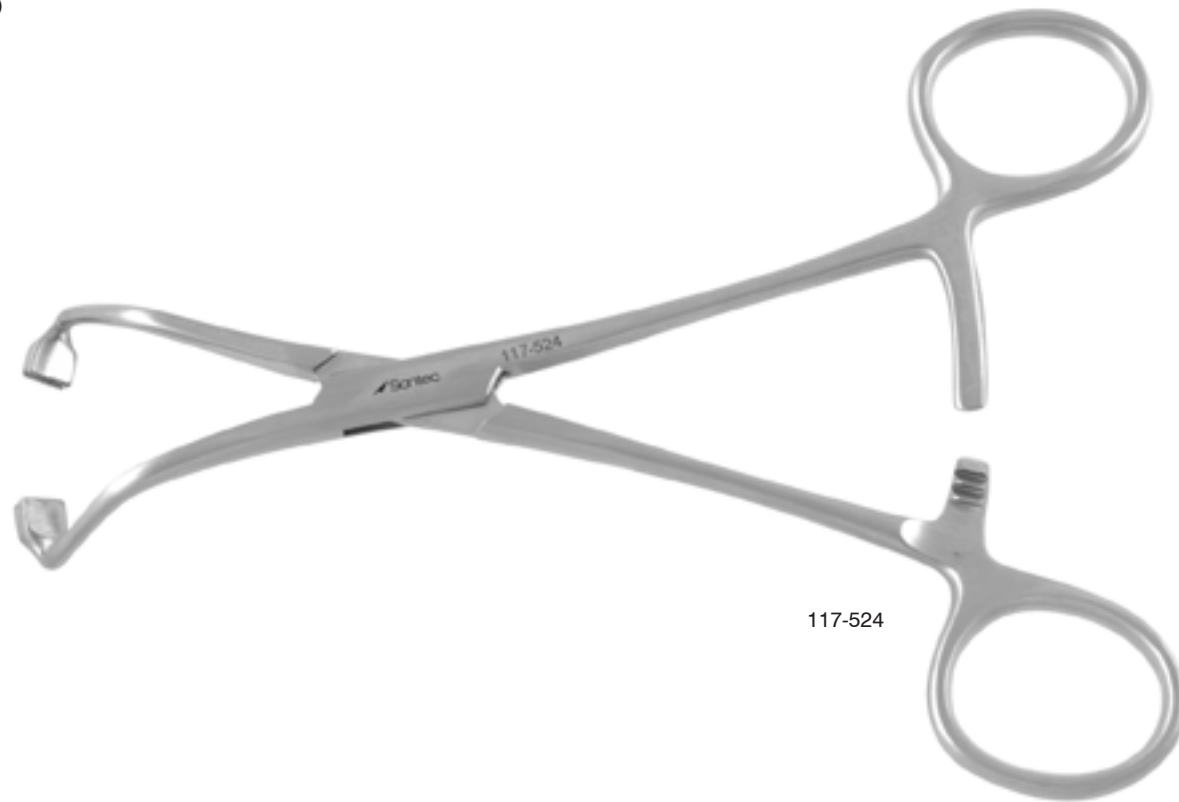

117-524

**Roeder Towel Forceps**

Beaded prongs / 5 1/4" (13.3 cm)  
117-506

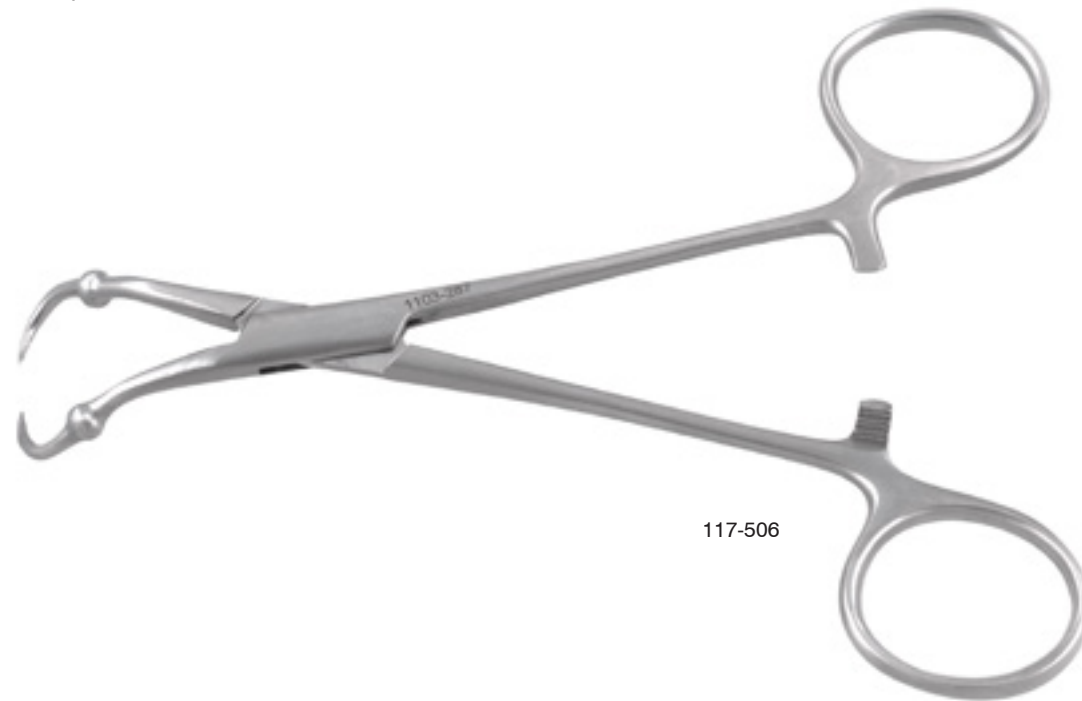

117-506

**Towel Clamp**

4 1/2" (11.4 cm)  
117-516 4 mm serrated disc  
117-517 8 mm serrated disc

Serrated / 5 1/4" (13.3 cm)  
1105-110 4 mm serrated disc

Serrated / 5 1/2" (14 cm)  
1105-112 8 mm serrated disc

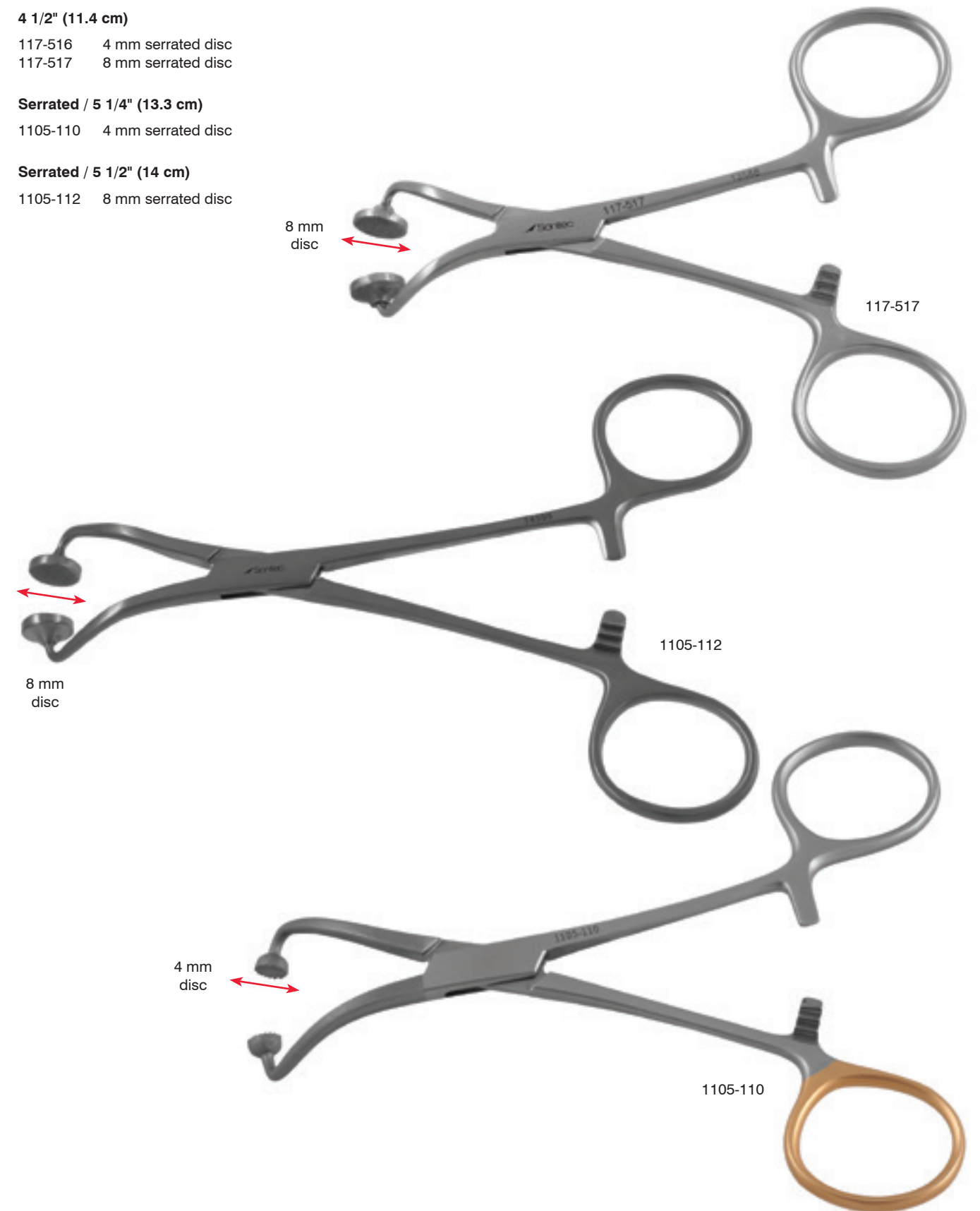

8 mm disc

117-517

8 mm disc

1105-112

4 mm disc

1105-110



 Sontec Instruments®

ENT CURETTES

**Meyerhoefer-Chalazion Curette**

5" (12.5 cm)

- 12-1285 0.5 mm
- 12-1290 1.0 mm
- 12-1300 1.5 mm
- 12-1310 1.75 mm
- 12-1320 2.0 mm
- 12-1355 2.5 mm
- 12-1360 3.0 mm
- 12-1365 3.5 mm
- 12-1367 4.0 mm
- 12-1368 4.5 mm

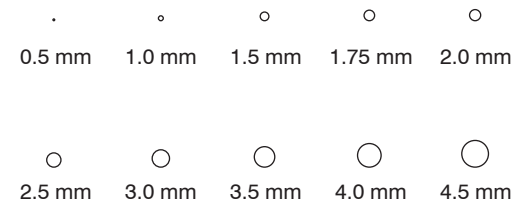

12-1368

**Shapleigh Ear Curette**

Serrated loop / 6" (15 cm)

- 467-430 small angled
- 467-431 small straight
- 467-432 large angled
- 467-433 large straight

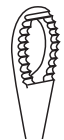

467-430



467-433

**Shapleigh Ear Curette**

Smooth loop / octagonal handle / 6" (15.2 cm)

- 467-434 small straight
- 467-4341 small angled
- 467-435 large straight
- 467-4351 large angled



467-434



467-4341



467-435

**Williger Curette**

Double-ended / 5 1/2" (14 cm) / str

- 467-4131 #0/1
- 467-4132 #00/0
- 467-4133 #1/2
- 467-4134 #3/4

Double-ended / 5 1/2" (14 cm) / each end angled 45°

- 467-4131A #0 / 1
- 467-4132A #00 / 0
- 467-4133A #1 / 2



66-0165

**Martini Bone Curette**

Double-ended / straight / 3mm/4mm / 5 1/2" (14 cm)

- 467-415



467-415

**Billeau Ear Loop/Curette**

6 1/2" (16.5 cm)

- 467-440XS extra small
- 467-440 small
- 467-438 medium
- 467-436 large

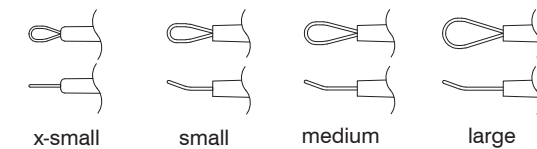

467-440

**House Curette**

**Double-ended / 5 3/4" (14.5 cm)**

199-133 both ends cvd 1.5 mm x 1.2 mm micro tip



**Double-ended / 6" (15 cm)**

199-132 one end angled, one end str  
199-129 both ends angled  
199-131 both ends str



**Double-ended / 7" (18 cm)**

199-130 both ends angled

**Double-ended / 9" (22.8 cm)**

199-136 both ends straight



**Frontal Sinus Curette**

**7 1/2" (19 cm)**

320-769 straight  
320-770 55°  
320-771 90°



**Tholl Curette**

**Double ended / 8 1/4" (21 cm)**

320-949



**Sontec® Excavator Curette**

**Single-ended / 5" (12.5 cm)**

199-300 1 mm  
199-308 1 mm w/ hole  
199-302 1.5 mm  
199-310 1.5 mm w/ hole  
199-304 2 mm  
199-312 2 mm w/ hole  
199-306 2.5 mm  
199-314 2.5 mm w/ hole



**Double-ended / 5 1/2" (14 cm) / with hole**

199-320 1.5 mm / 2 mm  
199-322 1.5 mm / 2.5 mm



**Buck Ear Round Handle Curette**

**Round Handle / str / blunt / 5 3/4" (14 cm)**

- 467-371 size 000
- 467-370 size 00
- 467-372 size 0
- 467-374 size 1
- 467-376 size 2
- 467-378 size 3



467-372

**Round Handle / str / sharp / 5 3/4" (14 cm)**

- 467-389 size 000
- 467-390 size 00
- 467-392 size 0
- 467-394 size 1
- 467-396 size 2
- 467-398 size 3

**Round Handle / angled / blunt / 5 3/4" (14 cm)**

- 467-379 size 000
- 467-380 size 00
- 467-382 size 0
- 467-384 size 1
- 467-386 size 2
- 467-388 size 3



467-380

**Round Handle / angled / sharp / 5 3/4" (14 cm)**

- 467-403 size 000
- 467-404 size 00
- 467-406 size 0
- 467-408 size 1
- 467-410 size 2
- 467-412 size 3

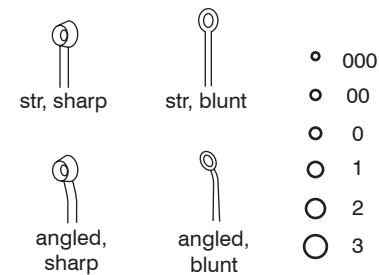

**Buck Ear Hex Handle Curette**

**Hex handle / str / blunt / 5 3/4" (14 cm)**

- 467-371S size 000
- 467-370S size 00
- 467-372S size 0
- 467-374S size 1
- 467-376S size 2
- 467-378S size 3



467-370S

**Hex handle / str / sharp / 5 3/4" (14 cm)**

- 467-389S size 000
- 467-390S size 00
- 467-392S size 0
- 467-394S size 1
- 467-396S size 2
- 467-398S size 3



467-398S

**Hex handle / angled / blunt / 5 3/4" (14 cm)**

- 467-379S size 000
- 467-380S size 00
- 467-382S size 0
- 467-384S size 1
- 467-386S size 2
- 467-388S size 3



467-386S

**Hex handle / angled / sharp / 5 3/4" (14 cm)**

- 467-403S size 000
- 467-404S size 00
- 467-406S size 0
- 467-408S size 1
- 467-410S size 2
- 467-412S size 3

**Hex handle / angled / sharp / 6 1/2" (16.5 cm)**

- 467-410HL size 2



467-410HL

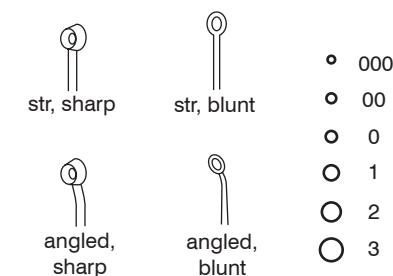



 Sontec Instruments®

GOUGES



**Brauer Rocking Nasal Chisel**

13 mm / 6 1/4" (15.9 cm)  
467-505

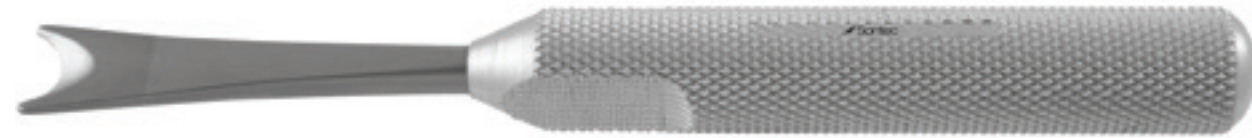

467-505

**Parkes Gouge**

6.5 mm / 7" (18 cm)  
330-051



330-051

**Killian-Claus Septum Gouge**

Bayonet / v-tip / 6 1/2" (16.5 cm)  
330-061



330-061

**Walter Meniscus Gouge**

7 1/2" (19.1 cm)  
330-070 3 mm  
330-072 5 mm  
330-074 12 mm

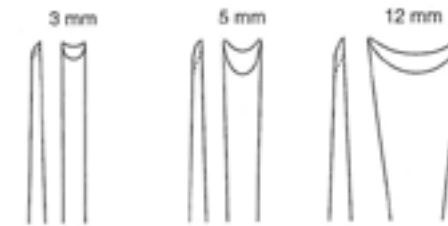

**Capener Lamina Cranked Gouge**

Bayonet / 9 1/2" (24 cm)  
330-054 6 mm  
330-058 11 mm  
330-056 13 mm



330-056

**Smith-Petersen Gouge**

**Straight / 8" (20.5 cm)**

- 330-630 6 mm (1/4") tip
- 330-631 9 mm (3/8") tip
- 330-632 13 mm (1/2") tip
- 330-633 16 mm (5/8") tip
- 330-634 19 mm (3/4") tip
- 330-635 25 mm (1") tip
- 330-636 32mm (1 1/4") tip



330-633

**Curved / 8" (20.5 cm)**

- 330-640 6 mm (1/4") tip
- 330-641 9 mm (3/8") tip
- 330-642 13 mm (1/2") tip
- 330-643 16 mm (5/8") tip
- 330-644 19 mm (3/4") tip
- 330-645 25 mm (1") tip
- 330-646 32mm (1 1/2")tip

**Cobb Type Spinal Gouge**

**11" (20.5 cm)**

- 330-650 straight
- 330-651 medium curve
- 330-652 strong curve
- 330-653 reverse curve



330-652

**Sontec Micro Gouge**

**5 1/2" (14 cm)**

- 475-803 3mm
- 475-804 4mm
- 475-805 5mm
- 475-806 6mm



475-803

**Mini Lexer Gouge**

**7" (18 cm)**

- 330-020 4 mm tip
- 330-021 6 mm tip
- 330-022 8 mm tip
- 330-023 10 mm tip
- 330-024 12 mm tip



330-024



330-023



**Lexer Gouge**

**8 3/4" (22.5 cm)**

- 330-030 7 mm tip
- 330-031 10 mm tip
- 330-032 15 mm tip
- 330-033 20 mm tip
- 330-034 25 mm tip
- 330-035 30 mm tip



330-033

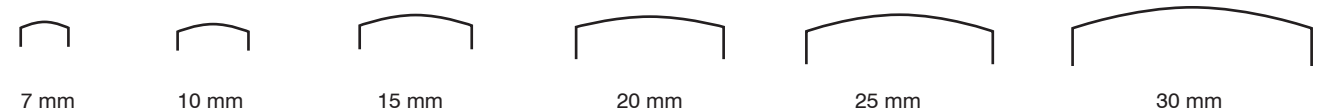

**Hibbs Gouge**

**Straight / 9 1/2" (24.1 cm)**

- 330-590 1/4"
- 330-591 3/8"
- 330-592 1/2"
- 330-593 5/8"
- 330-594 3/4"
- 330-595 7/8"
- 330-596 1"
- 330-597 1 1/8"
- 330-598 1 1/4"
- 330-599 1 1/2"



330-591

**Curved / 9 1/2" (24.1 cm)**

- 330-600 1/4"
- 330-601 3/8"
- 330-602 1/2"
- 330-603 5/8"
- 330-604 3/4"
- 330-605 7/8"
- 330-606 1"
- 330-607 1 1/8"
- 330-608 1 1/4"
- 330-609 1 1/2"

**Hibbs Chisel**

**Straight / 9 1/2" (24.1 cm)**

- 330-500 1/4"
- 330-511 3/8"
- 330-512 1/2"
- 330-513 5/8"
- 330-514 3/4"
- 330-515 7/8"
- 330-516 1"
- 330-517 1 1/8"
- 330-518 1 1/4"
- 330-519 1 1/2"



330-517

**Curved / 9 1/2" (24.1 cm)**

- 330-530 1/4"
- 330-531 3/8"
- 330-532 1/2"
- 330-533 5/8"
- 330-534 3/4"
- 330-535 7/8"
- 330-536 1"
- 330-537 1 1/8"
- 330-538 1 1/4"
- 330-539 1 1/2"

**Sontec Chisel**

**Curved / 7 1/4" (18.4 cm)**

- 330-460 7 mm



330-460

**Straight / 7 1/4" (18.4 cm)**

- 330-462 6 mm
- 330-464 8 mm
- 330-466 10 mm
- 330-468 12 mm
- 330-470 16 mm
- 330-472 22 mm



330-464



330-466



330-468



330-470



330-472



 Sontec Instruments®

ENT Plastic OSTEOTOMES

**Neivert Anderson Guarded Osteotome**

With single guard / 8" (20 cm)

- 350-826 straight
- 350-826N straight narrow
- 350-824 curved right
- 350-824N curved right narrow
- 350-825 curved left
- 350-825N curved left narrow

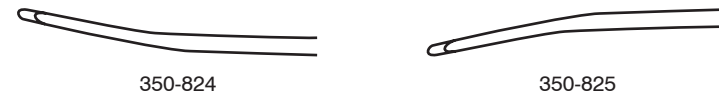

350-826



350-824N



350-825N

**Silver Guarded Osteotome**

With single guard / 7" (18 cm)

- 350-827 straight
- 350-829 curved right
- 350-828 curved left



350-828

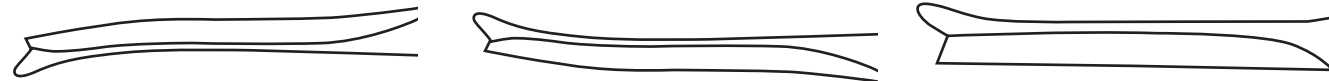

350-827

350-828

350-829

With single guards / 6 mm / 8" (20.3 cm)

- 475-794 straight
- 475-798 curved right
- 475-796 curved left

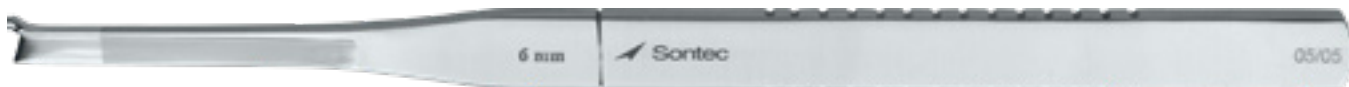

475-794



**Cinelli Guarded Osteotome**

With double guards / 6 1/4" (15.9 cm)

- 475-760 13/32" (10 mm)
- 475-762 15/32" (12 mm)
- 475-764 9/16" (14 mm)
- 475-766 5/8" (16 mm)



475-762

**Pitanguy U-Shaped Osteotome**

Semi-guarded / 8" (20 cm)

- 475-719 11/32" (9 mm)
- 475-722 15/32" (12 mm)
- 475-725 19/32" (15 mm)



475-719

**Brauer-Cottle Osteotome**

Graduated / cruciform / flat / 7 3/4" (19.7 cm)

- 475-734 5/32" (4 mm)
- 475-737 9/32" (7 mm)
- 475-739 11/32" (9 mm)
- 475-742 15/32" (12 mm)



475-737

**Rubin Rounded Corner Osteotome**

6 3/4" (17 cm)

- 475-750 13/32" (10 mm)
- 475-752 15/32" (12 mm)
- 475-754 9/16" (14 mm)
- 475-753 5/8" (16 mm)

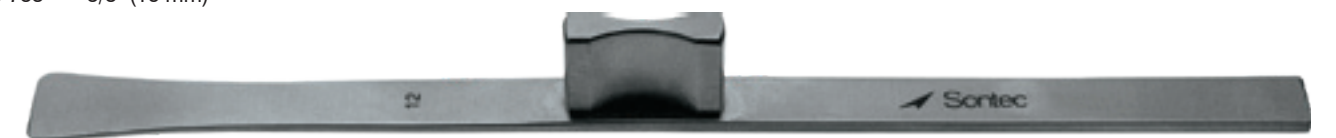

475-752

**Micro Plastic Surgery**

With guide / with special guide pin / 7 1/4"

- 475-785G1 2.5 mm
- 475-785G2 3mm

No guards / straight / 8" (20 cm)

- 475-785A 2.5 mm
- 475-785B 3mm
- 475-785C 4mm
- 475-785D 6mm
- 475-785E 8mm
- 475-785F 10mm
- 475-785G 12mm
- 475-785H 14mm



475-785G2



475-785C

**"V" Sontec®**

6" (15 cm)

- 478-768 (4 mm) upturned
- 478-770 (4 mm) downturned
- 478-772 (2 mm)
- 478-773 (3 mm)
- 478-774 (4 mm)
- 478-775 (5 mm)
- 478-776 (6 mm)
- 478-778 (8 mm)
- 478-780 (10 mm)
- 478-782 (12 mm)
- 478-785 (15mm)

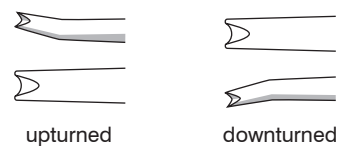

478-768



478-774

**Plastic Surgery Guarded Osteotome**

With single guard / straight / 8" (20.3 cm)

- 475-782 1/4" (6 mm)
- 475-783 5/16" (8 mm)
- 475-784 13/32" (10 mm)

With double guards / straight / 8" (20.3 cm)

- 475-775 13/32" (10 mm)
- 475-776 15/32" (12 mm)
- 475-777 9/16" (14 mm)
- 475-778 5/8" (16 mm)

With single guard / curved / 8" (20.3 cm)

- 475-768 5/16" (8 mm) right
- 475-769 5/16" (8 mm) left
- 475-770 13/32" (10 mm) right
- 475-771 13/32" (10 mm) left
- 475-772 15/32" (12 mm) right
- 475-773 15/32" (12 mm) left



475-768



475-769

With double guards / curved / 8" (20.3 cm)

- 475-779 13/32" (10 mm)
- 475-780 15/32" (12 mm)



475-779

**Alexander Osteotome**

Square serrated handle / straight / 7" (17.8 cm)

- 330-302 2 mm
- 330-303 3 mm
- 330-304 4 mm
- 330-305 5 mm
- 330-306 6 mm
- 330-308 8 mm
- 330-310 10 mm
- 330-312 12 mm
- 330-314 14 mm

**Plastic Surgery Osteotome**

Without guards / curved / 8" (20.3 cm)

- 475-790 5/16" (8 mm)
- 475-791 13/32" (10 mm)
- 475-792 15/32" (12 mm)



475-791

**Schrom Guarded Osteotome**

With guide / 7 3/4" (19.5 cm)

- 350-835ST straight
- 350-835LF curved for left side
- 350-835RT curved for right side

Black model / ceramic coated / with guide / 7 3/4" (19.5 cm)

- 350-835STB straight
- 350-835LFB curved for left side
- 350-835RTB curved for right side



350-835ST



350-835LF



350-835LFB



350-835RTB

**Alexander Osteotome**

Square serrated handle / straight / 7" (17.8 cm)

- 330-302 2 mm
- 330-303 3 mm
- 330-304 4 mm
- 330-305 5 mm
- 330-306 6 mm
- 330-308 8 mm
- 330-310 10 mm
- 330-312 12 mm
- 330-314 14 mm



330-302

**Cook Guarded Osteotome**

Right / upward / 6 1/2" (16.4 cm)

- 478-789 2 mm
- 478-788 3 mm
- 478-791 4 mm



478-788

Left / upward / 6 1/2" (16.4 cm)

- 478-790 2 mm
- 478-787 3 mm
- 478-792 4 mm

**Cakir Osteotome**

V-shaped blade / straight / 3 mm tip / 7" (18 cm)

- 475-787



475-787

**Famous Gubisch Nasal Osteotome**

Straight / delicate / 4 mm tip size / 7 3/4" (20 cm)

- 475-789



475-789

**Sontec® Pattern Plastic Osteotome**

7" (18 cm)

330-482	3/32" (2 mm)
330-483	1/8" (3 mm)
330-484	5/32" (4 mm)
330-485	6/32" (5 mm)
330-486	1/4" (6 mm)
330-487	9/32" (7 mm)
330-488	5/16" (8 mm)
330-489	11/32" (9 mm)
330-490	13/32" (10 mm)
330-491	7/16" (11 mm)
330-492	15/32" (12 mm)
330-495	19/32" (15 mm)



330-482

**Rees Osteotome**

Knurled aluminum handle / 7 3/4"

475-711	1/8" (3 mm)
475-712	5/32" (4 mm)



475-712

**Sontec Nasal Dorsum Osteotome**

With double guard blade / 6 7/8" (17 cm)

475-731	12mm
475-732	14mm



475-731



475-732

**Sontec Nasal Tip Cartilage Punch**

With handle / 4" (10 cm)

475-729	heart shaped
475-730	figure 8 shaped



475-729



475-730

**Sontec Osteotome**

Round Handle with disc end / 6 7/8" (17 cm)

475-743	2 mm
475-744	3 mm



475-743



475-744

**Sontec Intranasal Osteotome**

7" (18 cm)

475-745	4mm
475-746	7mm



475-745



475-746



**Sontec Type Lateral Osteotome**

With guard / 8" (20 cm)

- 475-747 curved left 4 mm
- 475-748 curved right 4 mm



475-747



475-748

**Cottle Gubisch Chisel**

Sloped chiseled tip and blade / 7" (18 cm)

- 475-800 5 mm
- 475-802 12 mm



475-800



475-802

**Blume Osteotome**

Curved / with guide / 7" (18 cm)

- 475-758 6 mm



475-758

**Obwegeser Ramus Osteotome**

Curved / 8 mm / 8 1/4" (21 cm)

- 475-749



475-749

**Epker Type Osteotome**

1.2 mm tip / 7" (18 cm)

- 330-320 straight 4 mm
- 330-322 straight 6 mm
- 330-324 straight 8 mm
- 330-326 slight curve 4 mm
- 330-330 slight curve 6 mm
- 330-336 full curve 6 mm
- 330-338 full curve 8 mm



330-320



330-322



330-326



330-330



330-336



330-338

**Walter Osteotome**

straight / 2 mm / 7 1/2"

- 475-810



475-810



 Sontec Instruments®

ENT Plastic ELEVATORS

**Woodson Elevator**

7 1/8" (18.1 cm)  
412-571



**Joseph Periosteal Elevator**

Curved / 6 3/4" (17 cm)

- 16-2207 3 mm
- 16-2208 3.5 mm
- 16-2209 4 mm
- 16-2210 5 mm
- 16-2200 6.5 mm



**Killian Elevator**

Double-ended / 7 1/4" (18.4 cm)  
412-536



**Masing Elevator / Dissector**

Double-ended / curved / octagonal handle / 7 7/8" (19.75 cm)  
412-575

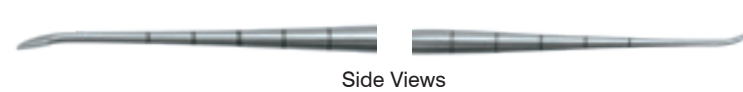

**Sontec-Masing Septal Dissector**

Double-ended / curved/curved / 8 1/4"  
467-535



**Sontec S.P.T. Elevator**

Round handle/ double-ended / curved / sharp / 8 1/4" (21 cm)  
412-583



**McKenty Elevator**

Semi-sharp / curved / 5 1/2" (14 cm)

- 412-5563 3 mm tip
- 412-556 4 mm tip
- 412-557 5 mm tip



Double-ended / curved / 8 1/2" (21.75 cm)

412-555



**Roger Elevator**

Double-ended / full curve / 7 1/4" (18.5 cm)  
412-558



**Mcdonald Elevator**

Double-ended / 7 1/2" (19 cm)  
412-585



**Freer Periosteal Elevator**

Double-ended / square handle / straight  
/4.5 mm tip / sharp/blunt / 7 3/4"

1100-798S

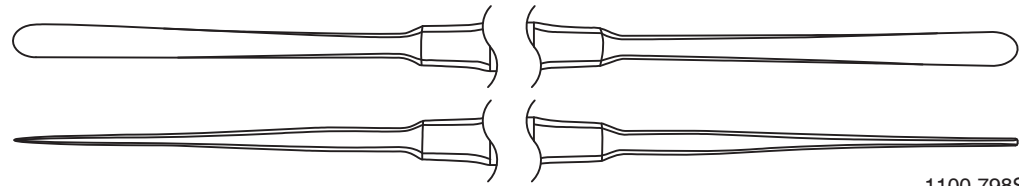

1100-798S

Double-ended / square handle / curved /  
4.5 mm tip / sharp/blunt

1100-798 7 3/4"

1100-798F 8 3/4"



1100-798

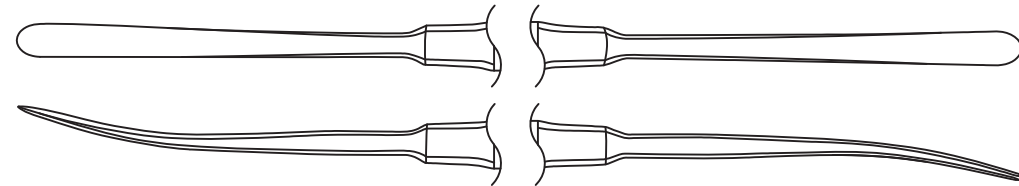

Double-ended / square handle / curved /  
6.5 mm tip / sharp/blunt

1100-798A 7 3/4"

1100-798E 8 3/4"



1100-798A

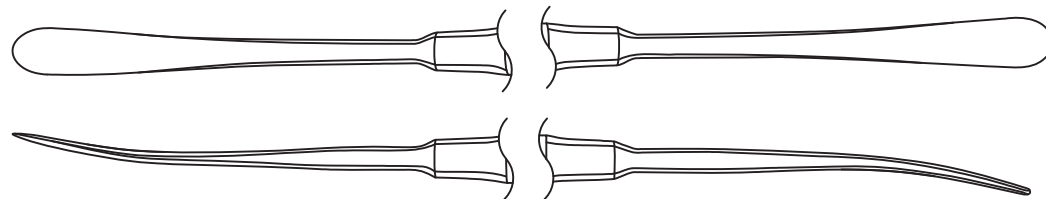

**Freer Periosteal Elevator**

Double-ended / round handle / curved /  
sharp/blunt / 7 1/2"

1100-798B 5 mm tip

1100-798C 6.7 mm tip



1100-798B

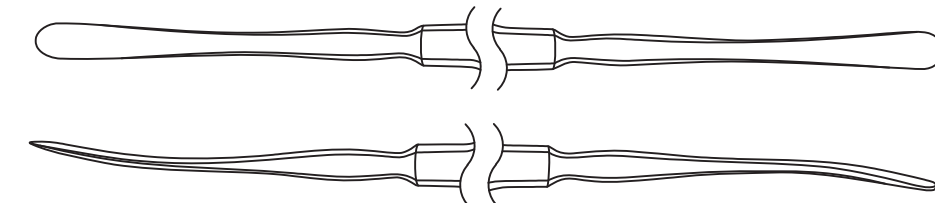

1100-798C

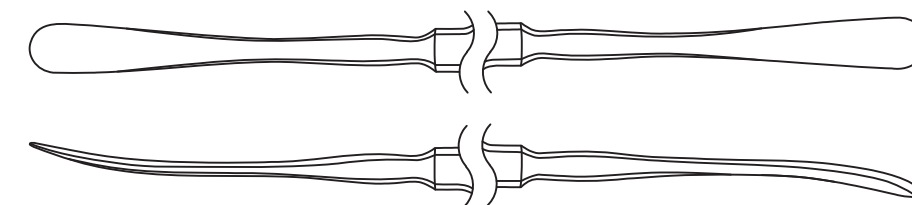

Double-ended / knurled round handle /  
curved / 4.5 mm tip / sharp/blunt / 6 3/4"

1100-798D



1100-798D

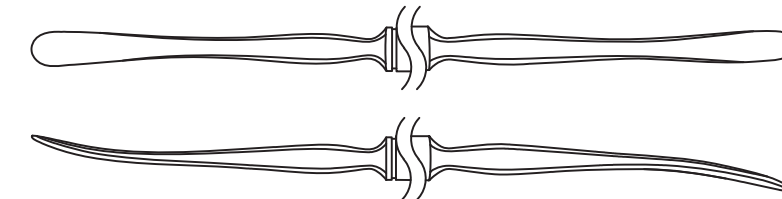

**Freer Elevator / Mucosa Knife Round Handle 4.5 mm**

Double-ended / 4.5 mm / 7 3/4" (19.5 cm)  
468-163



468-163

**Freer Elevator / Packer**

Double-ended / 4.5 mm / 7 3/4" (19.5 cm)  
468-165



468-165

**Joseph Massing Elevator**

Bayonet shaft / 8" (20 cm)  
335-105



335-105

Straight / 6 mm / 8" (20.3 cm)  
335-106



335-106

**Pennington Elevator**

Double-ended / 8 1/4" (21 cm)  
412-580



412-580

**House Ear Elevator**

1 mm tip / 6 1/4" (16 cm)  
468-140



468-140

**Cottle Elevator**

Slight curve / 9 mm tip  
/ 7 1/2" (19 cm)  
412-527



412-527

**Boies Nasal Fracture Elevator**

9 mm / wide tip blunt / 7 1/2" (19.1 cm)  
345-315



345-315

**Sontec® Cottle Elevator**

Double-ended / sharp & blunt /  
graduated / 8 1/4" (21 cm)  
1271-302



1271-302

**Sesamoid Cottle Elevator**

Strong curve / double-ended / 9" (23 cm)  
1271-310



1271-310

**CSU Cottle Elevator**

Double-ended / graduated /  
9" (23 cm)  
1271-300 blunt  
1271-301 sharp



1271-300

**Cottle Daniel Raspatory/Packer**

Double-ended / 8 1/2" (22 cm)  
1271-309



1271-309

**Daniel-Gubisch Raspatory/Rasp**

Double-ended / rasp-elevator / 8 1/2" (22 cm)  
1271-307



1271-307

**Sontec® Septum Elevator / Probe**

Double-ended / with ball tips / 7" (18 cm)  
468-150



468-150

**Barns Septum Elevator**

Double-ended / 7 3/4" (19.5 cm)  
467-532 60° disc end/60° 4.5 mm elevator end  
467-533 disc end/4.5 mm Freer end



467-532



467-533

**Maxillary Ostium Elevator / Probe**

Double-ended / with ball tips / 8 1/4" (21 cm)  
468-160



468-160

**Ostium Burnisher Elevator**

Ball #42 / 1.9 & 1.2mm diameters /  
double-ended / 6 1/2" (16 cm)  
1102-BR42



1102-BR42

**Cleft Palate Elevator**

Double-ended / with perpendicular  
blades / 6 1/4" (18 cm)  
478-395



**Cronin Cleft Palate Elevator / Dissector**

Rounded-blunt tip / 7" (18 cm)  
478-402 small  
478-405 medium  
478-400 large



478-402

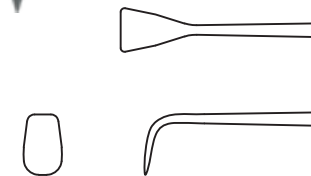

478-405

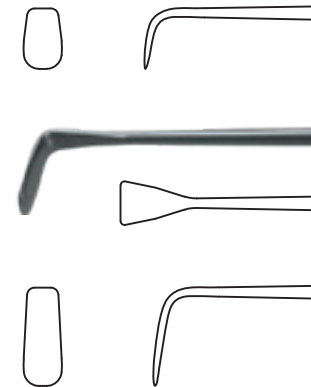

478-400



**Frontal Ostium Sound Elevator**

Double-ended w/ ball tips / 90 deg ang & cvd tips / 8 1/2" (21.5 cm)

468-161



468-161

**Lempert Elevator**

7 1/2" (19 cm)

412-519



412-519

**Sontec Forehead Lifter**

207-960	scalp	half curve	8 1/2" (21.5 cm)
207-961	scalp	quarter curve	9 3/4" (25 cm)
207-963	scalp	strong half curve	9 3/4" (25 cm)
207-966	orbital rim dissector	half curve	9 3/4" (25 cm)



207-960



207-961



207-963



207-966

**Endoscopic Forehead Lifter**

6 1/2" (16.5 cm) working length

- 207-950 set includes:  
 207-951 #1  
 207-952 #2  
 207-953 #3  
 207-954 #4  
 207-955 #5  
 207-956 #6  
 207-957 #7



207-951



207-952



207-953



207-954



207-955



207-956



207-957

**Forehead Lifting Elevator / Dissector**

Video endoscopic dissector / ergonomic lamb handle / 6 1/2" (16.5 cm) working length

- 207-921 #1 12 1/2" (30.5 cm)
- 207-922 #2 15 1/4" (39 cm)
- 207-923 #3 15 1/8" (38.8 cm)
- 207-924 #4 13" (33 cm)



207-921



207-922



207-923



207-924

**Zoellner Micro Ear Surgery Set**

Uniquely designed handle / 3 1/4" (8 cm)

Tip	Item #	Description
	68-1100	hook, 1.0 mm point, 90° angled down
	68-1102	hook, 1.0 mm point, 90° angled up
	68-1103	hook, 1.0 mm point, 60° angled down
	68-1104	hook, 1.0 mm point, 60° angled up
	68-1105	hook, 0.5 mm point, 45° angled down
	68-1106	hook, 0.5 mm point, 45° angled up
	68-1107	hook, 1.0 mm point, curved down
	68-1108	hook, 1.0 mm point, curved up
	68-1150	needle, straight, sharp point
	68-1120	round knife, 3.0 mm long, 45°, angled down
	68-1121	round knife, 3.0 mm long, 45°, angled up
	68-1131	elevator, 2.0 mm wide, curved down
	68-1132	elevator, 2.0 mm wide curved up
	68-1165	sickle knife, 5.0 mm, long, curved up
	68-1166	sickle knife, 5.0 mm, long curved down
	68-1170	spear-pointed needle, 5.0 mm long, curved to left
	68-1171	spear-pointed needle, 5.0 mm long, curved to right
	68-1180	raspatory, 2.0 mm wide, curved to left
	68-1181	raspatory, 2.0 mm wide, curved to right

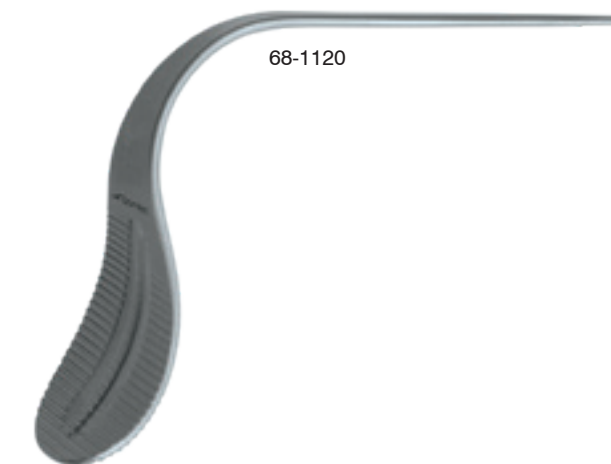

68-1120



68-1166



**Doyen Raspatory**

**Large 3.5 cm / 6 1/2" (16.5 cm)**

- 430-380 left
- 430-382 right
- 430-383 right delicate

**Small 2.5 cm / 6 1/2" (16.5 cm)**

- 430-384 left
- 430-386 right

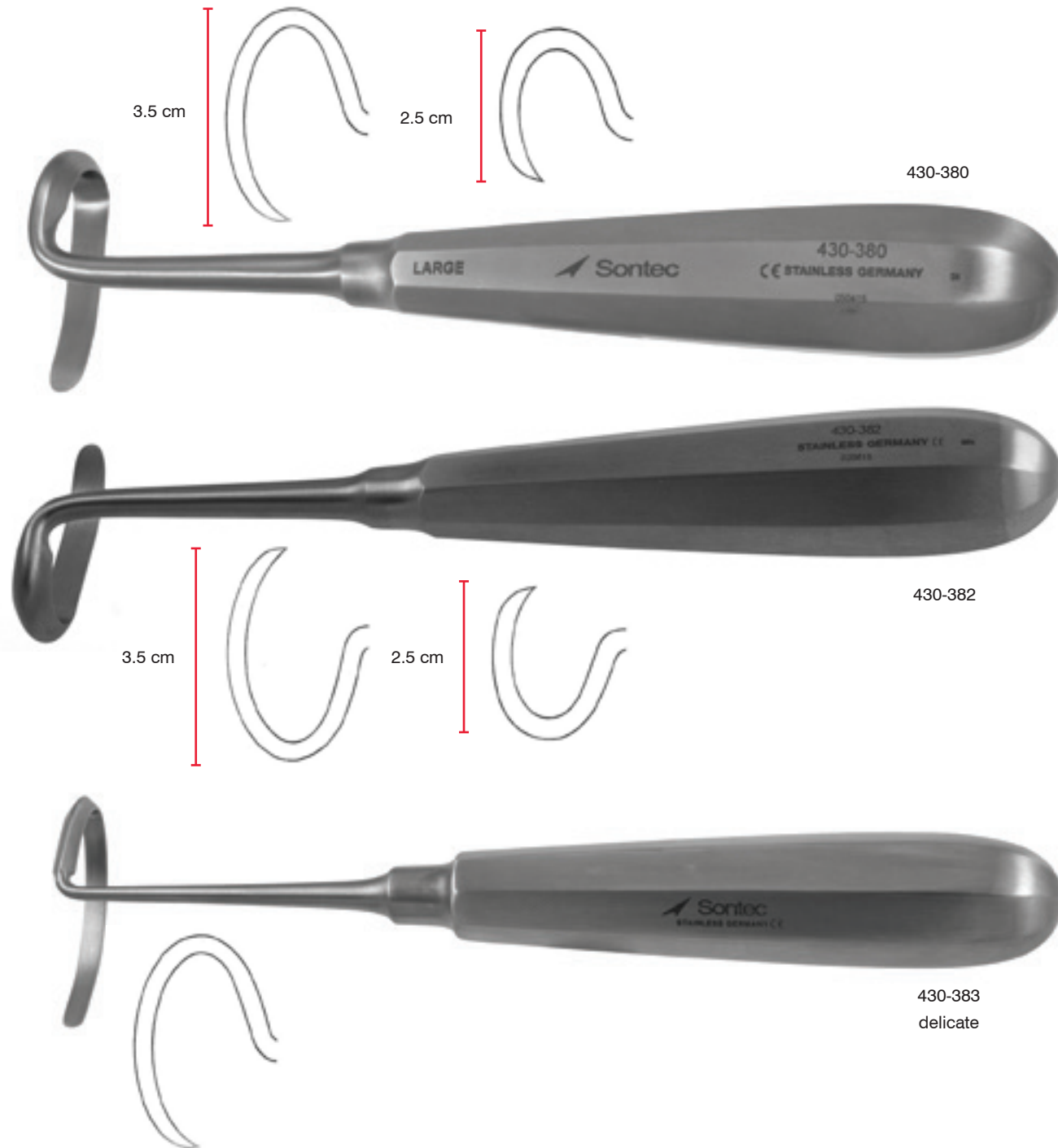

**Daniel Gubisch Rib Raspatory**

**6 3/4" (17.1 cm)**

- 430-378 right
- 430-379 left

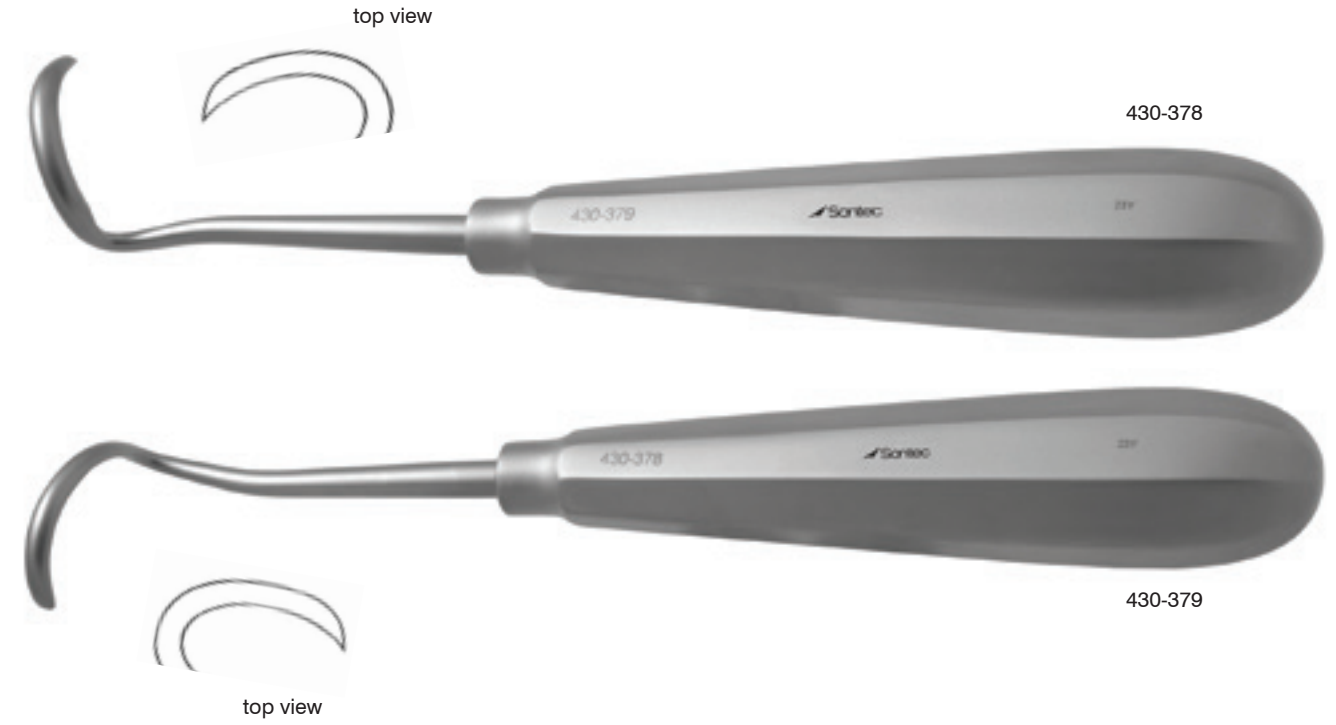

**Obwegeser Mandib Raspatory**

**6 3/4" (17.1 cm)**

- 430-375 right
- 430-376 left



**Sontec A O Type Elevator / Raspatory**

Phenolic handles / 7 / 12" (19 cm)

335-250	6 mm tip	str	flat edge
335-254	3 mm tip	slight curve	round edge
335-255	3 mm tip	slight curve	flat edge
335-260	6 mm tip	slight curve	flat edge
335-265	6 mm tip	slight curve	round edge

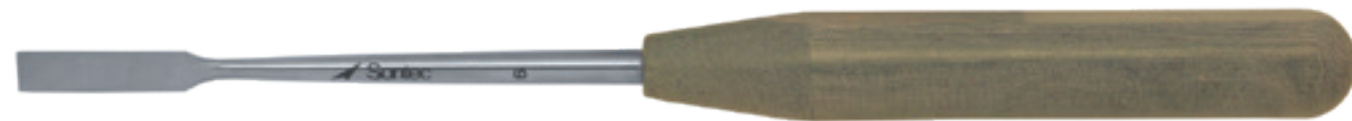

335-250

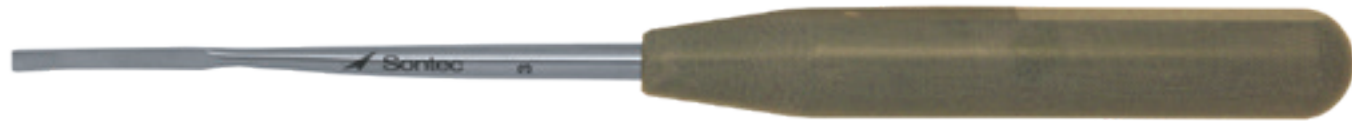

335-255



335-260

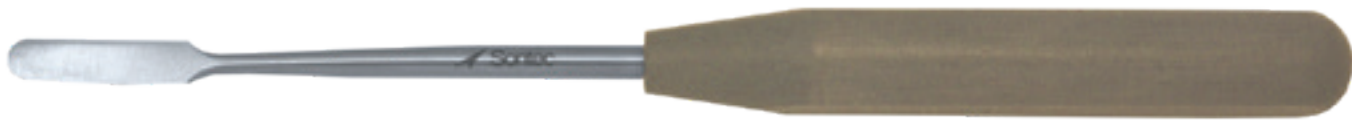

335-265



335-250



335-255



335-260



335-265

**Sontec A O Type Elevator / Raspatory**

Phenolic handles / 8" (20 cm)

335-270	13 mm tip	angled	flat edge
335-275	14 mm tip	str	round edge
335-280	14 mm tip	cvd	round edge
335-285	20 mm tip	str	round edge



335-270



335-275



335-280



335-285

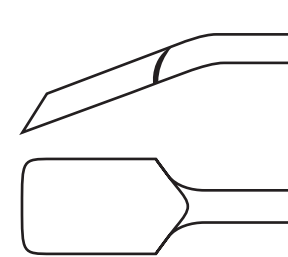

335-270

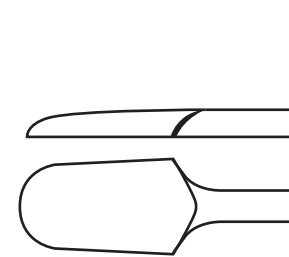

335-275

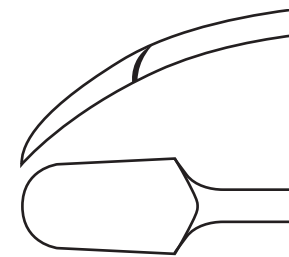

335-280

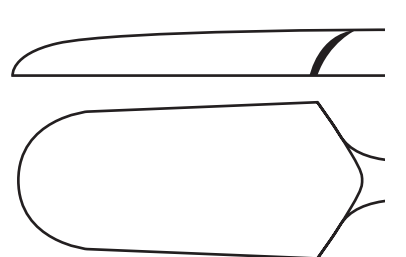

335-285



 Sontec Instruments®

ENT Plastic SUCTION ELEVATORS

**Pitanguy Raspatory Elevator With Suction**

7" (17 cm)

- 412-667A 2.5 mm
- 412-667B 3 mm
- 412-667D 3.5 mm
- 412-667C 4 mm



**Elevator With Suction**

7 1/4" (18.4 cm)

2700-320



**Daniel Endoscopic Forehead Elevator**

9 1/4" (23.5 cm)

478-370 slight curve with suction



**Pitanguy Elevator With Suction**

Blunt / 8" (20 cm)

475-855



**Haraldsson Elevator with Suction**

Distal tube connection swivels / 7 1/2" (19 cm)

478-360



**Gorney Elevator With Suction**

7 3/4" (20 cm)

478-375



**Gubisch Suction Elevator**

Straight

478-380 6"

478-382 8" bayonet





 Sontec Instruments®

ENT SPECULUMS

**Tieck-Halle Infant Nasal Speculum**

5 3/4" (14 cm)

16-2330 stainless  
16-2332 ebonized



16-2330

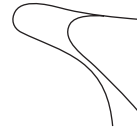

**Sonnenschein Nasal Speculum**

6" (15.2 cm)

465-320



465-320

**Killian Septum Speculum**

5 1/2" (14 cm)

465-309 2" thin low profile blades  
465-311 2 1/2" thin low profile blades  
465-313 3" thin low profile blades



465-321

**Killian Nasal Speculum**

Fixation screw / with universal fiber  
optic light guide / 5 1/4" (13.5 cm)

465-321 35mm  
465-322 50mm  
465-323 75mm



465-321



465-322



465-323

**Killian Nasal Speculum**

With universal fiber optic light guide / 85 mm / 5 1/2" (14 cm)

465-325



465-325

**Modified Cottle Speculum**

Tapered thin wide blades / 6" (15 cm)

16-2365 2" thin low profile blades



16-2365

**Cottle Speculum**

X-delicate / 5 1/2" (14 cm)

465-301 50 mm



465-301

**Cottle Septum Speculum**

Includes screw set / ebony finish / very thin blades / complete black / 5 3/4" (14 cm)

- 465-299 35 mm
- 465-300 50 mm
- 465-302 75 mm
- 465-304 100 mm



465-300

Includes screw set / ebony finish / narrow blades / 6" (15.2 cm)

- 16-2368 35 mm
- 16-2372 50 mm
- 16-2374 75 mm
- 16-2376 90 mm



16-2372

**Pashley Nasal Speculum Set**

12 mm gap / one long blade & one short blade / 5 1/2" (14 cm) / 68 mm x 8.5 mm blade / adult

- 1463-118 right
- 1463-120 left

12 mm gap / one long blade & one short blade / 5 1/2" (14 cm) / 65 mm x 6 mm blade / pediatric

- 1463-119 right
- 1463-117 left

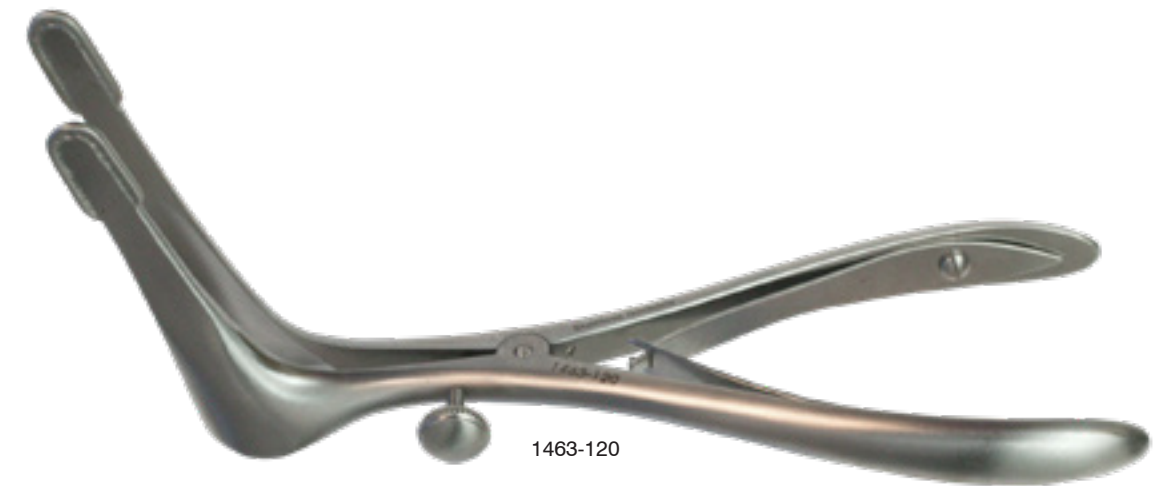

1463-120

### Hartmann Ear Specula

Set of three (3 mm, 4 mm, 5 mm)

465-225

Set of four (4 mm, 5 mm, 6 mm, 7 mm)

465-227

Also available individually

- 465-225-3 3mm
- 465-225-4 4mm
- 465-225-5 5mm
- 465-225-6 6mm
- 465-225-7 7mm



465-225

### Boucheron Ear Specula Chrome

Chrome / set of four

- 465-210 size 1-4
- 465-220 size 5-8

Also available individually

- 465-210-1 size 1
- 465-210-2 size 2
- 465-210-3 size 3
- 465-210-4 size 4
- 465-220-5 size 5
- 465-220-6 size 6
- 465-220-7 size 7
- 465-220-8 size 8

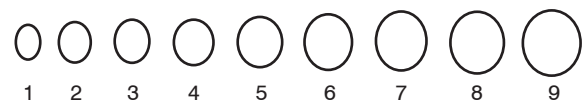

465-210

### Gruber Ear Specula

Oval / standard adult sizes / long pattern / chrome

- 465-241 size 1 4 mm x 5 mm
- 465-242 size 2 5 mm x 6 mm
- 465-243 size 3 6 mm x 7 mm
- 465-244 size 4 7 mm x 8 mm

Set of four

465-240 size 1-4

Oval / standard child sizes / long pattern / chrome

- 465-251 size 1 2 mm x 3 mm
- 465-252 size 2 3 mm x 4 mm
- 465-253 size 3 4 mm x 5 mm
- 465-254 size 4 5 mm x 6 mm

Set of four

465-250 size 1-4

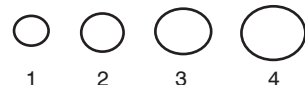

465-240

### Farrior Ear Specula

Oval / angled end / non-glare stainless

- 465-231 size 1 3 x 4 mm
- 465-232 size 2 4 x 5 mm
- 465-233 size 3 4.5 x 5.5 mm
- 465-234 size 4 5 x 6 mm
- 465-235 size 5 5.5 x 6.5 mm
- 465-236 size 6 6 x 7 mm
- 465-237 size 7 6.5 x 7.5 mm
- 465-238 size 8 7 x 8 mm
- 465-239 size 9 7.5 x 8.5 mm

Oval / angled end / black

- 465-231B size 1 3 x 4 mm
- 465-232B size 2 4 x 5 mm
- 465-233B size 3 4.5 x 5.5 mm
- 465-234B size 4 5 x 6 mm
- 465-235B size 5 5.5 x 6.5 mm
- 465-236B size 6 6 x 7 mm
- 465-237B size 7 6.5 x 7.5 mm
- 465-238B size 8 7 x 8 mm
- 465-239B size 9 7.5 x 8.5 mm

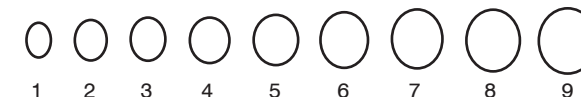

465-237

### Farrior Ear Specula

Round / black / partial opening

- 465-260 set of all 4 below
- 465-262 4 mm
- 465-264 5 mm
- 465-266 6 mm
- 465-268 7 mm



465-262

### Farrior Ear Specula

Round / black / full opening

- 465-270 set of all 4 below
- 465-272 4 mm
- 465-274 5 mm
- 465-276 6 mm
- 465-278 7 mm

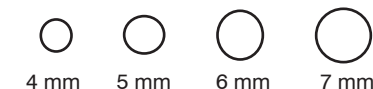

465-272



**Sewall Tongue Depressor**

13 x 67 mm / 6 1/2" (16.5 cm)

485-422 13 x 67 mm



485-422

**Bruenings Tongue Depressor**

7 1/2" (19 cm)

485-476 13 x 67 mm



485-476

**Doyen Tongue Depressor**

5" (12.7 cm)

485-479



485-479

**Wieder Tongue Depressor**

With a widely-flared depressing / surface for increased traction and visibility / 5 1/2" (14 cm)

- 485-590 small 30 mm wide
- 485-592 large 35 mm wide
- 485-592S large 35 mm wide with suction



485-592S

**Dingman Mouth Gag Set**

Adjustable upper retractor blades and cheek retractors / complete with three grooved tongue blades

485-500-SET frame and 3 tongue blades

Blades also sold individually

485-501 small 24mm x 52mm  
 485-502 medium 28mm x 55mm  
 485-503 large 30mm x 68mm



485-500-SET



485-501



485-501



485-502



485-503

**Mclvor Mouth Gag Set**

7 1/4" (18.5 cm)

485-580 set with frame and 3 blades

485-582 frame only

485-584 small blade size 1 blade 1 x 2 1/2"

485-586 medium blade size 2 blade 1 x 3 1/2"

485-588 large blade size 3 blade 1 x 4"



485-584

485-582

**Jennings Mouth Gag**

- 485-510 infant 3 1/2" spread
- 485-512 small 4 1/4" spread
- 485-514 medium 5" spread
- 485-516 large 6" spread



**Davis Mouth Gag Frame**

- 485-528 left side bite
- 485-530 right side bite





 Sontec Instruments®

ENT Plastic HOOKS

**Sontec Tissue Twist Hook**

5 1/2" (14 cm)  
199-372



199-372

**Frazier Skin Hook**

5" (12.5 cm)  
199-380 sharp  
199-382 blunt



199-380

**Hartman Ear Hook**

6 1/4" (15.9 cm)  
467-441



467-441

**Tyrell Skin Hook**

5" (12.5 cm)  
199-385 sharp  
199-387 blunt



199-385

**Gillies Skin Hook**

7" (18 cm)  
199-390 large  
199-391 small



199-391

**Gillies Skin Hook Titanium**

Small / sharp / 6 1/2" (16.5 cm)  
199-384T

Large / sharp / 6 1/4" (15.9 cm)  
199-3841T



199-384T

199-3841T

**Cottle Double Skin Hook**

Sharp / 5 1/2" (14 cm)  
199-394



199-394

**Cottle Skin Hook**

5 1/2" (14 cm)  
199-393A angled  
199-393B shallow curve  
199-393C deep curve



angled shallow curve deep curve

6 1/4" (15.9 cm)  
199-392 angled  
199-392A angled 180°



199-393C

199-392

199-392A

**Cottle Skin Hook Titanium**

Angled 180° / 17.5 cm / 7" (17.8 cm)  
199-392T



199-392T

**Cottle Skin Hook Titanium**

Angled 180° / 6 1/4" (15.9 cm)  
199-3921T



199-3921T

**Freer Double Skin Hook**

2.5 mm wide / 6" (15 cm)  
199-395 sharp  
199-396 blunt



199-395

**Sontec Freer Skin Hook Titanium**

Flat handle / 2 sharp prongs / 3 mm wide / 6" (15 cm)  
199-402T



199-402T

**Sontec Freer Double Skin Titanium**

Flat handle / 2 blunt prongs / 3 mm wide / 6" (15 cm)

199-401T



199-401T

**Sontec® Skin Hook**

Sharp / 2 mm prong / 4 3/4" (12 cm)

199-400



199-400

**Sontec® Skin Hook Titanium**

Ergonomic flat handle/ small / 5" (12.7 cm)

199-470T



199-470T

**O'Connor Skin Hook**

4 3/4" (11.5 cm)

199-406



199-406

**O'Connor Skin Hook Titanium**

1 sharp prong / 4 3/4" (11.5 cm)

199-406T



199-406T

**Guthrie Skin Hook**

Sharp / 5" (12.5 cm)

199-410 1.5 mm wide

199-411 2.5 mm wide large



199-410

**Guthrie Hook Titanium**

Flat handle / 2 sharp prongs / 5" (12.7 cm)

199-412T 3 mm

199-413T 3 mm

199-4131T 2 mm



199-412T



199-413T



199-4131T

**Seltzer Dermal Biopsy Hook**

Sharp / 4 1/2" (11.4 cm)

199-405



199-405

**Day Ear Hook**

6 3/4" (17 cm)

467-443 small

467-445 large



467-445

**Gross Ear Hook & Spoon**

5 1/4" (13 cm)

467-448



467-448

**Allport Muscle Hook**

6 3/4" (17 cm)

468-155



468-155

**Allport Mastoid Searcher**

With ball tip / 6 1/2" (16.5 cm)

468-156



468-156

**Pashley Hook**

Probe with round handle / 6 1/2" (16.5 cm)

1197-673 right angle hook  
1197-675 malleable hook



1197-673



1197-675

**Sontec Hook Probe Titanium**

90° angle / 1.8 mm x 9 mm / 8" (20.3 cm)

2700-506



2700-506

**Converse Skin Hook**

Single-ended / aluminum Handle / 6" (15 cm)

475-100 small  
475-101 medium  
475-102 large  
475-104 straight small  
475-103 straight large



475-100



475-101



475-102



475-103



475-104

**Kleinert-Kutz Skin Hook**

5" (12.5 cm)

475-136 small 3 mm diameter  
475-137 medium 5 mm diameter  
475-138 large 7 mm diameter



475-136



475-137



475-138

**Frazier Skin Hook**

5" (12.5 cm)

199-380 sharp  
199-382 blunt



199-380

**Adamson Double-ended Hook and Retractor**

7.5 mm x 5 mm retractor / 3 mm hook / 6 1/4" (15.9 cm)

205-700



205-700

**Joseph Skin Hook**

Two prong / sharp  
 199-485 6" (15 cm)  
 199-484 7" (18 cm)



**Joseph Skin Hook Titanium**

Round handle / 2 sharp prongs / 7 mm / 6 1/4" (15.9)  
 199-420T



**Meyerdig Skin Hook**

6 1/4" (16 cm)  
 205-850



**Converse Nasal Tip Skin Hook**

Double-ended / 4" (10 cm)  
 475-540 sharp  
 475-542 blunt



**Converse Combo Sharp/Blunt Skin Hook**

Double-ended / sharp/blunt / 5 1/2" (14 cm)  
 475-539



**Sontec Alar Stabilizing Jig**

5" (12.5 cm)  
 475-543



**Freeman Skin Hook**

With finger loop / 4" (10 cm)  
 475-546 1 prong  
 475-547 2 prongs



**Humby Variable Skin Hook**

2 swivel hooks / 4 3/4" (12 cm)  
 475-550



**Modified Humby Skin Hook**

Sharp / 6" (15 cm) / 2 adjustable prongs / with handle  
 475-552



**Kilner Deluxe Skin Hook**

Small / 6" (15 cm)  
 199-375



**Mammoplasty & Mastectomy Hook**

7 1/2" (19 cm)  
 475-549





**Joseph Skin Hook**

Single prong ball tip / 6 1/4" (16 cm)

199-415



199-415

**Joseph Skin Hook**

Sharp / 1 prong / 6 1/4" (16 cm)

199-414



199-414

**Joseph Skin Hook**

Sharp / 2 prongs / 6 1/4" (16 cm)

- 199-416 2 mm
- 199-418 5 mm
- 199-420 7 mm
- 199-422 10 mm
- 199-430 12 mm
- 199-438 14 mm
- 199-446 16 mm
- 199-458 18 mm



199-422

**Joseph Blunt Ball Tips Skin Hook**

Ball tip / 2 prongs / 6 1/4" (16 cm)

- 199-426 10 mm
- 199-434 12 mm
- 199-442 14 mm
- 199-450 16 mm
- 199-462 18 mm



199-426



199-450

**Joseph Skin Hook Electro Blue**

Sharp / 2 prongs / blue electro coat / 6 1/4" (16 cm)

- 199-417 2 mm
- 199-4182 5 mm
- 199-419 7 mm
- 199-424 10 mm
- 199-432 12 mm
- 199-440 14 mm
- 199-448 16 mm
- 199-460 18 mm



199-419

**Joseph Blunt Ball Tips Skin Hook Electro Blue**

Ball tip / 2 prongs / blue electro coat / 6 1/4" (16 cm)

- 199-421 7 mm
- 199-428 10 mm
- 199-436 12 mm
- 199-444 14 mm
- 199-452 16 mm
- 199-464 18 mm



199-436

**Jackson Tracheal Hook**

5 1/2" (14 cm)

502-394



502-394

**Sontec Tracheal Hook Titanium**

Sharp / 90° angled / 4 mm 6 1/4" (15.9 cm)

502-393T



502-393T

**Rake Retractor**

6 1/2" (16.5 cm)

- 205-880 sharp 1 prong
- 205-884 blunt 1 prong
- 205-881 sharp 2 prongs
- 205-885 blunt 2 prongs
- 205-882 sharp 3 prongs
- 205-886 blunt 3 prongs

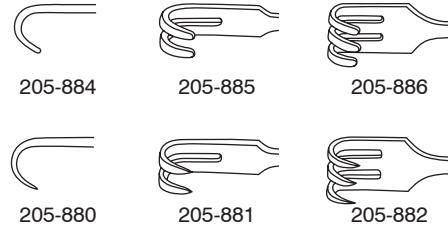

205-881

**Neivert Hook Retractor**

Double ended / 7 1/2" (19.1 cm)

199-397S



199-397S

**Cottle Neivert Hook Retractor**

Double ended / 8 1/2" (21.6 cm)

199-397



199-397S

**Neivert Retractor**

Rhinoplastic / double ended / 6 1/4" (16 cm)

199-398



199-398

**Mandible Bone Hook**

8" (20 cm)

320-937



320-937

**Sontec® Bone Hook**

9" (23 cm)

- 320-925 small
- 320-930 medium
- 320-935 large



320-930

**Kilner Skin Retractor Hook**

With finger ring / 2 prongs / 3 1/4" (8 cm)

220-160



220-160

**Finger Ring Retractor Hook**

Sharp / 2 prongs / 10 mm / 1 3/4" (4.4 cm)

220-143



220-143

**Millard Thumb Retractor Hook**

**Sharp**

- 220-145 1 prong
- 220-149 2 prongs 14 mm
- 220-150 2 prongs 18 mm



**Thumb Ring Skin Hook**

**Sharp / 2 prongs / 3 1/2" (9 cm)**

- 220-151 small
- 220-152 large



**Finger Ring Skin Hook**

**1 3/4" (4 cm)**

- 220-155 short hook
- 220-155L long hook



**Cottle Thumb Skin Hook**

**With finger ring / 2 prongs / 10 mm / 2" (5 cm)**

- 220-156

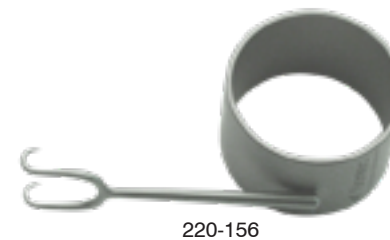

**Flexible Neck Hook Retractor**

**5" (13 cm)**

- 205-819 sharp 3 prongs

**6" (15 cm)**

- 205-820 sharp 1 prong
- 205-826 blunt 1 prong
- 205-822 sharp 2 prongs
- 205-828 blunt 2 prongs
- 205-824 sharp 3 prongs
- 205-830 blunt 3 prongs

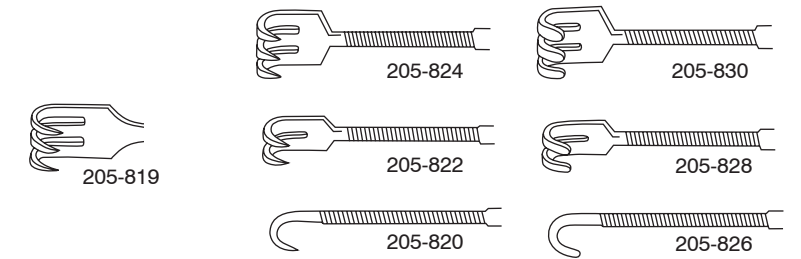

**Blair Hook Retractor**

**Four prongs / 5" (12.5 cm)**

- 205-847 sharp
- 205-848 blunt



**Knapp Rollet Hook Retractor**

**4 prongs / 5" (12.5 cm)**

- 205-844 sharp
- 205-846 blunt



**Anderson Bear Claw Hook Retractor**

**Sharp / 5" (12.5 cm)**

- 475-530 3 prongs
- 475-535 5 prongs



**Miller Skin Rake Retractor**

5" (12.5 cm)

- 199-480 9 prong sharp
- 199-481 9 prong blunt
- 199-482 6 prong sharp
- 199-483 6 prong blunt



199-481

**Paul Skin Rake Retractor**

Blunt / 5" (12.5 cm)

199-490



199-490

**Mini Rake Retractor**

6 1/4" (16 cm)

475-503



475-503

**Cottle Alar Retractor**

4 prong / 5 1/8" (13 cm)

205-865 8 mm

4 prong / delicate / long neck / 5 1/8" (13 cm)

205-864 7 mm



205-864



205-865

**Hook Retractor**

In-line prongs / four prongs / 7" (18 cm)

- 475-511 straight
- 475-510 narrow head
- 475-521 angled shaft

With shorter inner prongs / 7" (18 cm)

- 475-520 angled shaft 4 prong

Miniature model / with thumb ring / in-line prongs / four prongs

- 475-517 2 1/2" (6 cm)
- 475-518 4 1/2" (11.5 cm)



475-517

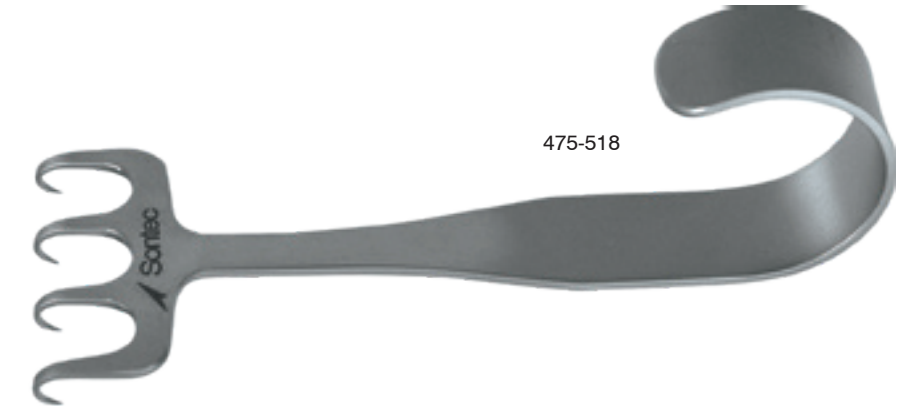

475-518



475-510



475-520

**Freeman Hook Retractor**

Seven Prongs / with shorter inner prongs / seven prongs / 7" (18 cm)

- 475-505
- 475-505A concave
- 475-505B convex



475-505A



475-505B

**Sontec-Yancoskie Coronal Lift Retractor**

6 off-set prongs / 8 1/2" (22 cm)

475-508



475-508

**Sontec Skin Retractor**

Round tapered edges / 6" (15.2 cm)

205-870



205-870

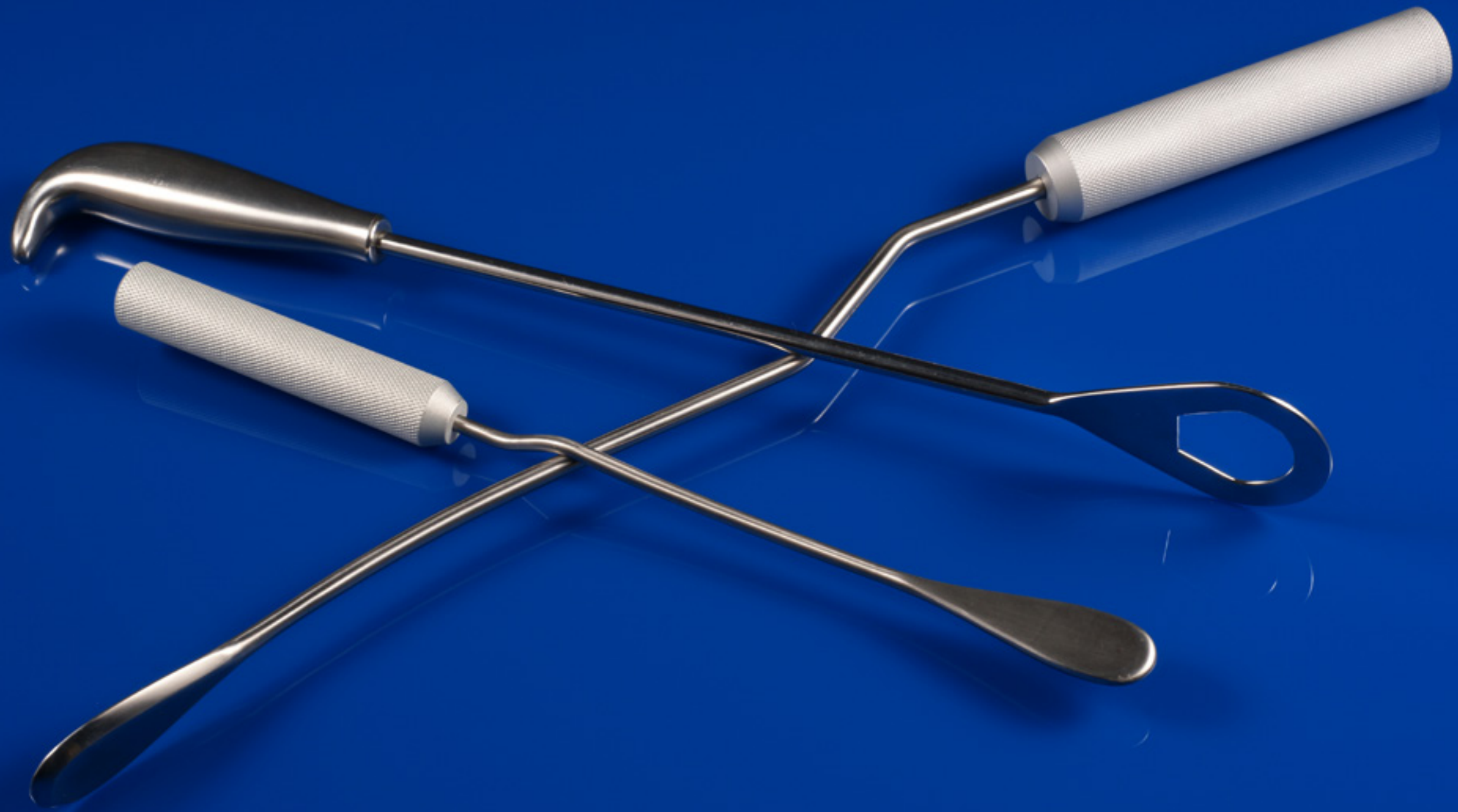

 Sontec Instruments®

ENT Plastic DISSECTORS

**Mammary & Calf Muscle Dissector**

14 3/4" (37.8 cm)  
475-940



475-940

**Golf Club Breast Dissector**

Angulated blade / rigid / 13" (33 cm)  
475-627



475-627

**MacCollum-Dingman Submammary Dissector**

12" (30 cm)  
475-635



475-635

**MacCollum-Dingman Breast Dissector**

16" (41 cm)  
475-630



475-630

**"J" Mammary Implant Dissector**

16" (40 cm)  
475-628



475-628

**Agris-Dingman Breast Dissector**

Graduated / 14 1/4" (36 cm)  
475-631L left  
475-632R right



475-631L

**Solz Breast Hook Dissector**

14 1/4" (36 cm)  
475-640L left  
475-640R right



475-640L

475-640R

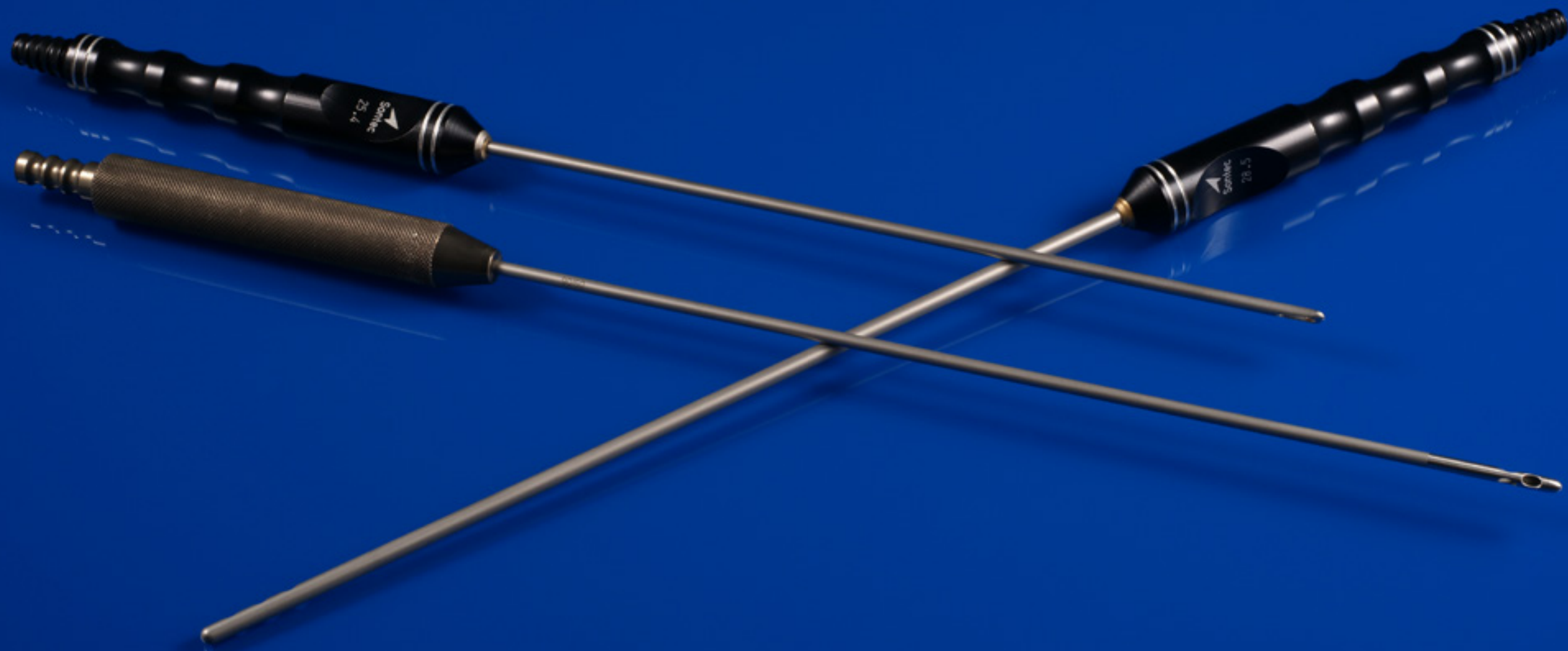

 Sontec Instruments®

Plastic Liposuction Cannulas



**Liposuction Cannula**

**Multi perforated tip / 15 3/4" (40 cm)**

Item#	
250x3 mm	201-330
250x4 mm	201-332
250x5 mm	201-334
280x4 mm	201-336
280x5 mm	201-338

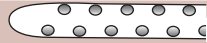

**Angled tip / 15 3/4" (40 cm)**

Item#	
150x3 mm	201-400
180x4 mm	201-402
250x4 mm	201-404
250x5 mm	201-406



**Spatulated tip / 15 3/4" (40 cm)**

Item#	
180x3 mm	201-350
180x4 mm	201-352
180x5 mm	201-354
220x3 mm	201-356
220x4 mm	201-358
250x4 mm	201-360
250x5 mm	201-362
280x4 mm	201-364
280x5 mm	201-366

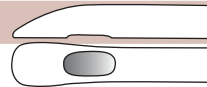

**Ring swiss point tip / 15 3/4" (40 cm)**

Item#	
220x3 mm	201-410
220x3.5 mm	201-412
250x3 mm	201-414
250x3.5 mm	201-416



**Spiral tip / 15 3/4" (40 cm)**

Item#	
220x4 mm	201-380
220x5 mm	201-382
250x3 mm	201-384
250x4 mm	201-386
280x3 mm	201-388
280x4 mm	201-390



**Liposuction Cannula**

The following tips are available with these three handles. Please be specific when ordering.



"A" Handle



"B" Handle



"C" Handle

**One hole / straight / 15 3/4" (40 cm)**

Item#	straight tip	curved tip
150x2 mm	201-002	n/a
150x3 mm	201-004	201-032
180x2 mm	201-006	n/a
180x3 mm	201-008	201-034
180x4 mm	201-010	n/a
220x3 mm	201-012	n/a
220x4 mm	201-014	201-036
220x5 mm	201-016	n/a
250x3 mm	201-018	n/a
250x4 mm	201-020	201-038
250x5 mm	201-022	201-040
280x3 mm	201-024	n/a
280x4 mm	201-026	n/a
280x5 mm	201-028	n/a
280x6 mm	201-030	n/a

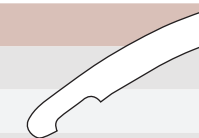

Liposuction Cannula

Tótem style / straight / 15 3/4" (40 cm)

Item#	1x2 holes	2x1 holes
220x3 mm	201-190	201-210
220x4 mm	201-192	201-212
250x3 mm	201-194	201-214
250x4 mm	201-196	201-216
250x5 mm	201-198	201-218
280x4 mm	201-200	201-220
280x5 mm	201-202	201-222

Tótem style / straight / 15 3/4" (40 cm)

Item#	Double- Model 1	Double- Model 2
250x4 mm	201-230	201-240
250x5 mm	201-232	201-242
280x4 mm	201-234	201-244
280x5 mm	201-236	201-246

Two hole/ straight / 15 3/4" (40 cm)

Item#	straight tip	curved tip
150x2 mm	201-050	n/a
150x3 mm	201-052	201-090
150x4 mm	201-054	201-092
180x2 mm	201-056	201-094
180x3 mm	201-060	201-096
180x4 mm	201-062	201-098
180x5 mm	201-064	n/a
220x3 mm	201-066	201-100
220x4 mm	201-068	201-102
220x5 mm	201-070	201-104
220x6 mm	201-072	n/a
250x3 mm	201-074	201-106
250x4 mm	201-076	201-108
250x5 mm	201-078	201-110
280x3 mm	201-080	n/a
280x4 mm	201-082	201-112
280x5 mm	201-084	201-114
280x6 mm	201-086	201-116



Liposuction Cannula

Three hole / Mercedes style / 15 3/4" (40 cm)

Item#	
150x2.5 mm	201-260
150x3 mm	201-262
150x4 mm	201-264
180x2.5 mm	201-266
180x3 mm	201-268
180x4 mm	201-270
180x5 mm	201-272
220x3 mm	201-274
220x4 mm	201-276
220x5 mm	201-278
250x3 mm	201-280
250x4 mm	201-282
250x5 mm	201-284
280x3 mm	201-286
280x4 mm	201-288
280x5 mm	201-290

Cobra style / 15 3/4" (40 cm)

Item#	
150x3 mm	201-162
180x2.5 mm	201-164
180x3 mm	201-166
180x4 mm	201-168
220x3 mm	201-170
220x4 mm	201-172
220x5 mm	201-174
250x2 mm	201-160
250x3 mm	201-176
250x4 mm	201-178
250x5 mm	201-180
280x3 mm	201-182
280x4 mm	201-184
280x5 mm	201-186



Three hole / straight tip / 15 3/4" (40 cm)

Item#	
150x2 mm	201-120
150x3 mm	201-122
150x4 mm	201-124
180x2 mm	201-126
180x3 mm	201-128
180x4 mm	201-130
180x5 mm	201-132
220x2 mm	201-134
220x3 mm	201-136
220x4 mm	201-138
220x5 mm	201-140
250x3 mm	201-142
250x4 mm	201-144
250x5 mm	201-146
280x3 mm	201-148
280x4 mm	201-150
280x5 mm	201-152
280x6 mm	201-154

Grated style tip / 15 3/4" (40 cm)

Item#	
180x3 mm	201-300
180x4 mm	201-302
220x3 mm	201-304
220x4 mm	201-306
250x3 mm	201-308
250x4 mm	201-310
250x5 mm	201-312
280x3 mm	201-314
280x4 mm	201-316



 Sontec Instruments®

ENT Plastic RETRACTORS

**Biggs Mammoplasty Retractor**

Narrow model

475-885L illuminated w/suction



**Fiber-Optic System**

For optimal visibility during surgery. Add illumination to your instruments. Including Retractors, Elevators, and Speculums. Sontec® can adapt a fiber-optic system to almost any instrument for better illumination of surgical sites. Please call Sontec® for more details.

475-885L

**Biggs Mammoplasty Retractor**

Narrow model

475-885 standard

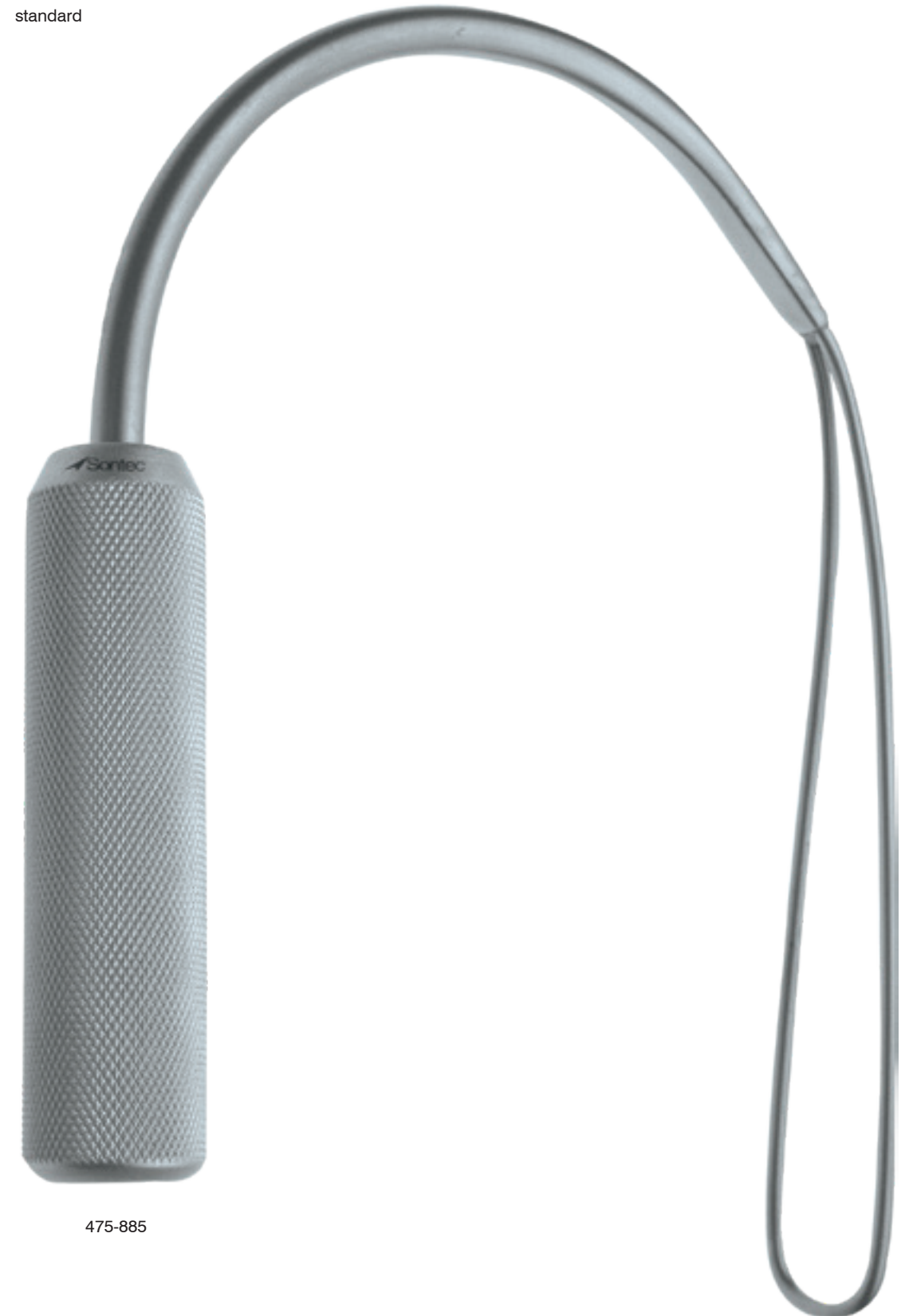

475-885

**Biggs Face Lift Retractor**

8" (20 cm) overall length

- 475-884 standard
- 475-884L illuminated



475-884

**Biggs Mammoplasty Retractor**

Standard model

- 475-886 standard
- 475-886L illuminated



475-886

**Ferreira Face Lift Retractor**

5" (12.5 cm) overall length

475-880

475-880L illuminated



**Aufricht Daniel Nasal Retractor**

4 1/4" (11 cm)

207-2929 50 x 10 mm



**Maliniac Nasal Retractor**

2" blade

475-878 3 1/2" overall length

475-878L 4" overall length with fiber optic light guide



**Ferreira Breast Augmentation Retractor**

With round smooth tip

With Light Guide	With Light Guide & Suction	Blades
475-926L	475-926LS	14 mm x 7 cm
475-927L	475-927LS	14 mm x 9 cm
475-928L	475-928LS	16 mm x 8 cm
475-929L	475-929LS	16 mm x 15 cm
475-931L	475-931LS	23 mm x 10 cm
475-932L	475-932LS	23 mm x 15 cm
475-933L	475-933LS	23 mm x 18 cm
475-934L	475-934LS	25 mm x 10 cm
475-935L	475-935LS	25 mm x 12 cm
475-936L	475-936LS	25 mm x 15 cm
475-937L	475-937LS	25 mm x 19 cm
475-938L	475-938LS </td <td>30 mm x 12 cm</td>	30 mm x 12 cm
475-939L	475-939LS	30 mm x 15 cm



475-931LS

**Breast Retractor**

Double-ended 12 1/2" (31 cm)

475-925 22 mm x 55 mm / 38 mm x 70 mm blades



475-925

**Ferreira Breast Augmentation Retractor**

25 mm x 190 mm blade / 6 1/2" (16.5 cm) overall length

475-930

475-930L illuminated



475-930

**Sontec Suction Wound Retractor**

With suction / illuminated / toothed straight edge

46933-00 90 mm x 24 mm

46933-02 90 mm x 30 mm

46933-04 115 mm x 24 mm

46933-06 150 mm x 36 mm

46933-08 190 mm x 30 mm



46933-00



**Sontec Suction Wound Retractor**

With suction / illuminated / smooth round edge

46934-00	80 mm x 16 mm
46934-01	100 mm x 24 mm
46934-02	120 mm x 25 mm
46934-03	120 mm x 30 mm
46934-04	150 mm x 25 mm
46934-05	150 mm x 30 mm
46934-06	170 mm x 40 mm



**Pitanguy Abdominal Retractor**

Straight

475-922	small 90 mm
475-921	medium 170 mm
475-920	large 190 mm



**Pitanguy Abdominal Retractor**

**Curved**

- 475-923 right
- 475-924 left (reverse)



475-923

**Converse Hand Retractor**

**3 3/4" (9.5 cm) overall length**

	Length	Straight blade	Curved blade
205-907 #1	3 1/2"	20 mm x 8 mm	22 mm x 8 mm
205-908 #2	3 1/2"	30 mm x 12 mm	25 mm x 12 mm
205-909 #3	3 7/8"	38 mm x 12 mm	25 mm x 12 mm
205-910 #4	3 7/8"	47 mm x 12 mm	25 mm x 12 mm
205-912	set of four (one of each style)		

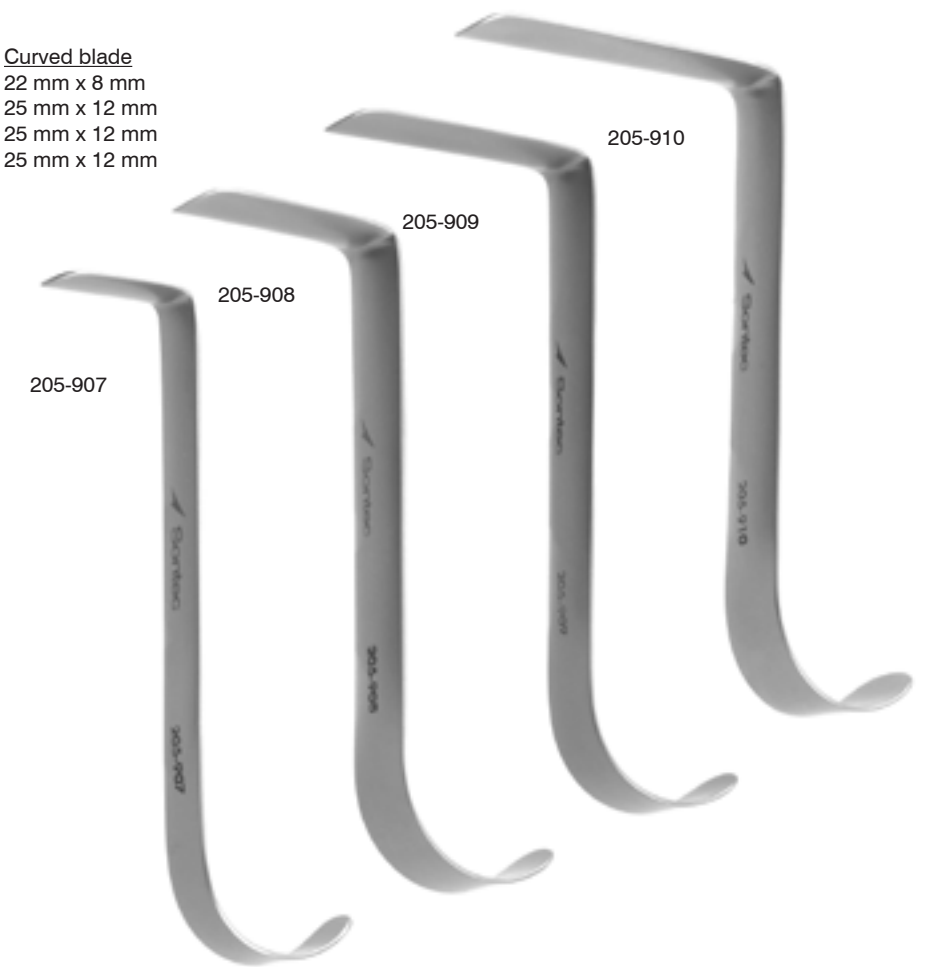

**Converse Hand Retractor**

**With fiber optic light guide / 5 1/4" (13cm) overall length**

205-907L	8x20mm
205-908L	12x30mm
205-909L	12x40mm
205-910L	12x50mm



205-907L

**Kasdan Hand Retractor**

**Double-ended / 1/2" x 1/4" (13 mm x 6.5 mm) and 3/4" x 3/8" (19 mm x 9.5 mm) 6 1/4" (15.9 cm)**

10-4280



10-4280

**Endoscopic Guidance Face Lift Retractor**

7 1/2" (19 cm)  
207-945



**Walter Forehead Retractor**

With fiber optic illumination and unit  
adaptor / 7" (18 cm)  
207-930



**Langenbeck Retractor**

With fiber optic light guide /  
medium blade / 10 1/4" (26cm)

207-289L



207-289L

**Freeman Flap Retractor**

1/2" wide

475-523

475-523C blue electro coat

1" wide

475-522

475-522C blue electro coat



475-523



475-522C

**Deaver Retractor**

- 207-420 1/4" x 7"
- 207-421 3/8" pediatric size
- 207-422 3/4" x 7"
- 207-422L 3/4" x 7" illuminated
- 207-423 7/8" x 8 1/2"
- 207-423A 5/8" x 8 1/2"
- 207-423L 7/8" x 8 1/2" illuminated
- 207-424 1" x 12"
- 207-424L 1" x 12" illuminated
- 207-425 1" x 13"
- 207-426 1" x 14"
- 207-427 1 1/2" x 12"
- 207-428 2" x 12"
- 207-429 3" x 12"
- 207-431 1" x 9"



**Deaver Retractor**

**Electro blue coated**

- 207-4221 3/4" x 7"
- 207-4231 5/8" x 8"
- 207-4232 3/4" x 8"
- 207-4234 1" x 8"
- 207-4242 1" x 12 1/2"
- 207-4271 1 1/2" x 12"
- 207-4281 2" x 12"

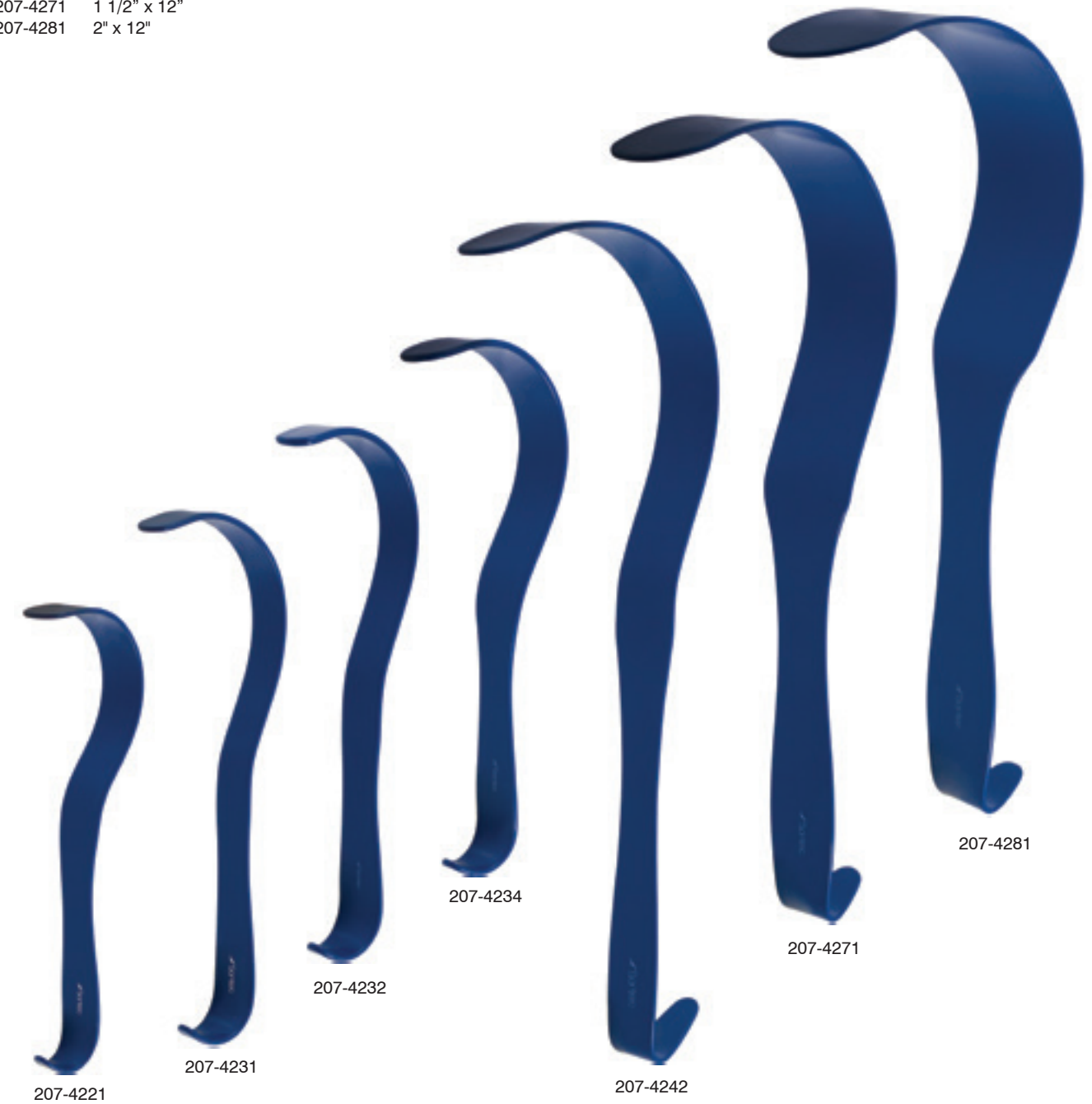

**Sontec S-Curve Retractor**

Sontec special model / hard/ flexible

207-417 3/4" tapered to 1/2" 8" (20cm)



**S-Curve Retractor**

Malleable

207-418	1/2"	8" (20 cm)
207-419-10	10 mm	7" (18 cm)
207-419-12	12.7 mm	7" (18 cm)



**Gruber Skin Hook**

With weight / 10 mm tip / 5" (12.7 cm)

199-383



**Tsur Open Rhinoplasty Retractor**

207-295

This retractor solves the problems of open rhinoplasty exposure by exposing the tip and dorsum of the nose simultaneously, enabling the surgeon to perform the operation with no assistance. The adjustable, flexible tension on the retracted skin and soft tissue prevents congestion and formation of edema to the retracted skin. The nasal prong adjusts and adapts to the shape of the nose, changing its position by using the sliding bar fixation screw. The tension on the retractor is easily adjusted by rubber bands, which enables flexible, adjustable elastic tension (not stiff like other retractors). - Padgett



**Walter Aufricht Nasal Retractor**

Double Ended / 5 1/4" (13.5 cm)

207-2924 4 mm  
207-2928 8 mm

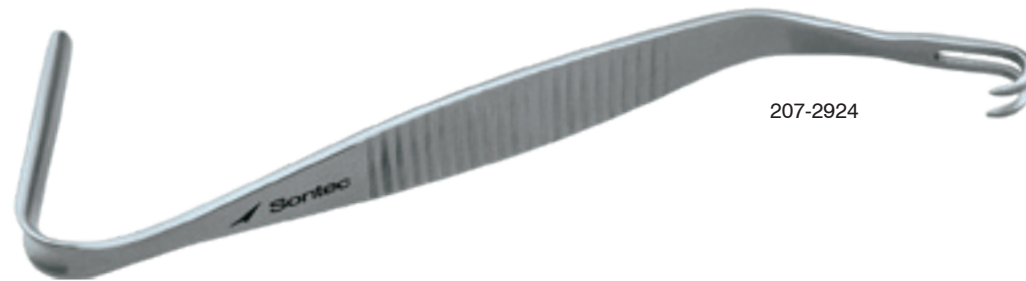

207-2924

**Walter Aufricht Nasal Retractor Titanium**

Double Ended / blunt / 8 mm / 5 1/4" (13.5 cm)

207-2928T



207-2928T

**Jackson Tracheal Retractor Titanium**

Double Ended / 2 sharp prongs / 6 3/4" (17.1 cm)

207-2924 4 mm



502-398T

**Trousseau Tracheal Dilator Retractor**

5 1/4" (13.3 cm) shaft

502-380 medium adolescent  
502-382 pediatric small  
502-384 adult large



502-380

502-382

**Craig-Sheehan Retractor**

4 prong / 7 1/2" (19 cm)

215-100

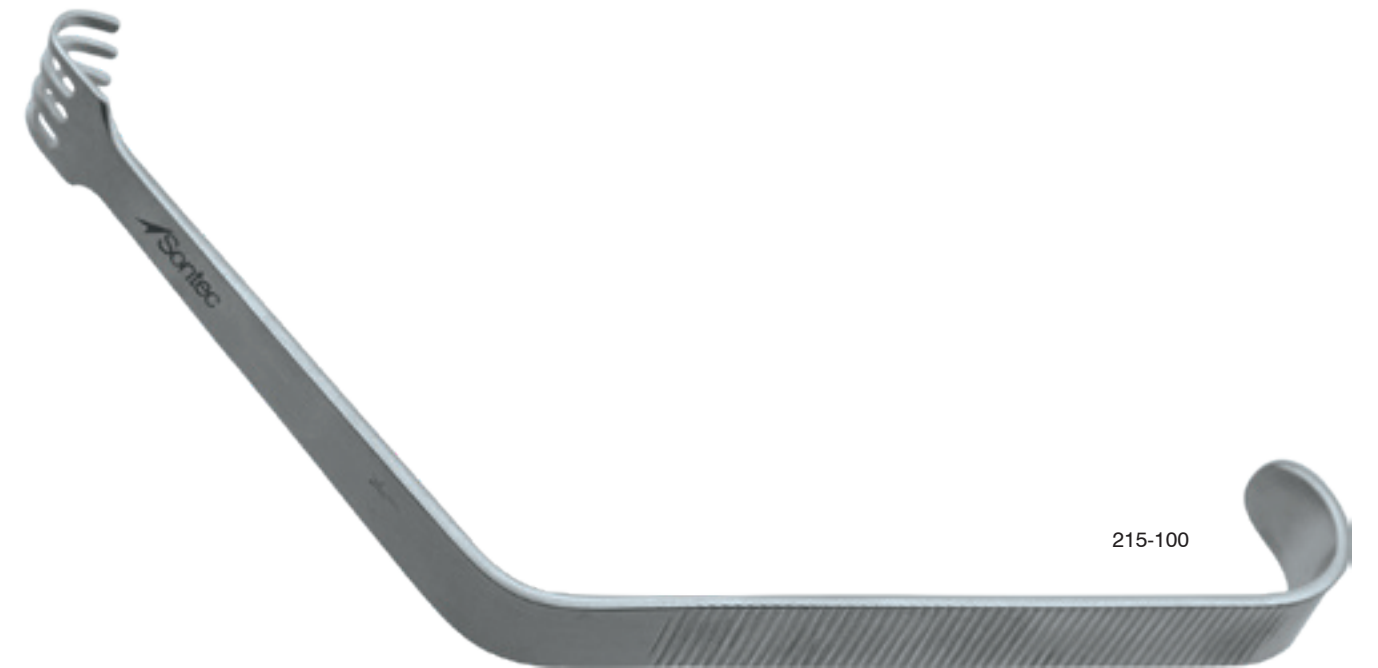

215-100

**LaRoe Tissue Spreader Retractor**

**Straight**

475-622 small 9" (23 cm)

**Curved**

475-623 small 9" (23 cm)  
475-625 large 10 1/4" (25.5 cm)

**Tapered**

475-624 medium 10 1/4" (25.5 cm)



475-624

**U.S. Army-Navy Retractor**

Set of 2 / 8 1/2" (21.5 cm)

1100-670



1100-670

**U.S. Army-Navy Retractor**

Set of 2 / blue electro coated / 8 1/2" (21.5 cm)

1100-670B



1100-670B

**Aufricht Nasal Retractor**

6 1/2" (16.5 cm) overall length

207-292	solid blade		10 x 45 mm
207-292L	solid blade	illuminated	10 x 45 mm
207-2925	solid blade		10 x 35 mm
207-290	open blade		
207-290L	fenestrated open blade	illuminated	
207-293	solid blade	non-reflective finish	
207-293L	solid blade illuminated	non-reflective finish	10 x 45 mm



207-292L

207-293

207-292

207-290



**Senn Retractor**

Double-ended / 6 1/4" (16 cm)

1100-668 sharp  
1100-668B blunt



1100-668

**Senn Retractor**

Blue electro coated / Double-ended / 6 1/4" (16 cm)

1100-669 sharp  
1100-669B blunt



1100-669



1100-669B

**Ragnell Retractor**

Double-ended / 6" (15 cm)

205-849



205-849

**Ragnell Retractor**

Blue coated / double-ended / 6" (15 cm)

205-849B



205-849B

**Richardson Retractor**

9 1/2" overall length / loop grip handle

207-338 1" x 3/4"  
207-340 1" x 1 1/4"  
207-342 1 1/2" x 1 1/2"  
207-345 2" x 3/4"

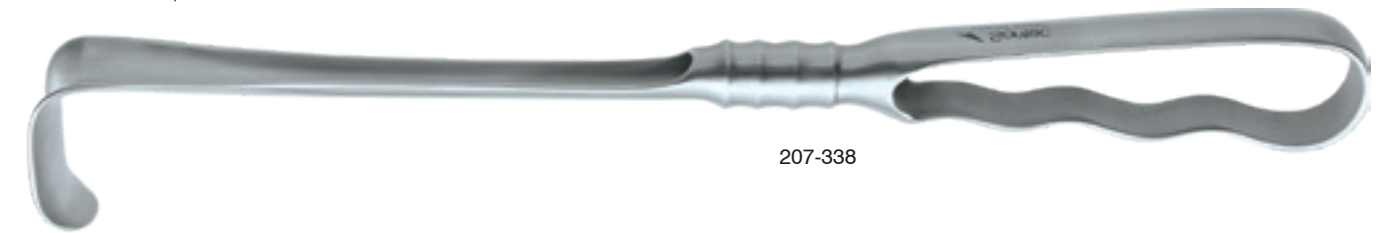

207-338

9 1/4" overall length / hollow grip handle

207-333 2" x 3/4"

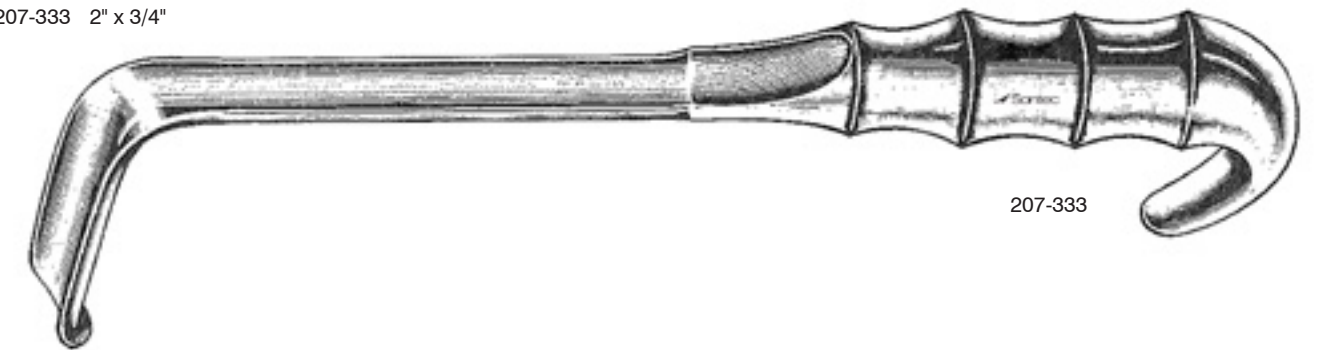

207-333

11" overall length / lamb grip handle

207-326 1" x 3/4"  
207-328 1 1/4" x 1"  
207-330 1 1/2" x 1 1/2"



207-326

**Parker Retractor Set**

Set of 2

1100-664 5" (12.5 cm)  
1100-666 7" (18 cm)



1100-664

**Malleable Ribbon Retractor**

**Malleable**

- 207-454 1/4" x 7"
- 207-455 3/8" x 7"
- 207-456 1/2" x 7"
- 207-460 5/8" x 7"
- 207-461 3/4" x 7"
- 207-462 1" x 7"
- 207-463 3/4" x 13"
- 207-464 1" x 13"
- 207-465 1 1/4" x 13"
- 207-466 1 1/2" x 13"
- 207-467 2" x 13"
- 207-468 2 1/2" x 13"
- 207-469 3" x 13"
- 207-470 3 1/2" x 13"
- 207-471 4" x 13"
- 207-472 5" x 13"
- 207-474 1 3/4" x 13"
- 207-473 2 3/4" x 13"



207-466

207-460



**Malleable Ribbon Retractor**

**Hollow Grip Handle**

- 207-482 3/4" wide blade
- 207-484 1" wide blade
- 207-486 1 1/4" wide blade
- 207-488 1 1/2" wide blade
- 207-490 2" wide blade



207-486



207-488

**Lead Hand Stabilizing Restrainer**

- 48-0339 pediatric 9 3/4" (25cm)
- 48-0340 adult 14 1/2" (37cm)



48-0339

**G Aufricht Nasal Retractor**

**Solid Blade / 7" (17.8 cm)**

207-2920 45x6 / 7 mm

**Solid Blade / 7 1/4" (18 cm)**

207-2921 45x9 / 7 mm



**Aufricht Nasal Retractor**

**Solid Blade / 6 3/4" (17 cm)**

207-2922 50x12 / 6 mm

207-2923 30x6 / 10 mm



**Desmarres Lid Retractor**

**Stainless steel / 5 1/2" (14 cm)**

- 10-4192 6 mm
- 10-4194 8 mm
- 10-4196 9 mm
- 10-4198 10 mm
- 10-4200 11 mm
- 10-4201 11 mm electro-blue coated
- 10-4206 12 mm
- 10-4207 12 mm electro-blue coated
- 10-4210 13 mm
- 10-4213 13 mm electro-blue coated
- 10-4216 14 mm
- 10-4220 15 mm



10-4200



10-4223

- 10-4223 15 mm electro-blue coated
- 10-4226 16 mm
- 10-4227 16 mm electro-blue coated
- 10-4230 17 mm



10-4236

- 10-4233 17 mm electro-blue coated
- 10-4236 18 mm
- 10-4237 18 mm electro-blue coated
- 10-4240 19 mm



**Kawamoto Double-Ended Retractor**

**14 mm x 16 mm / 6" (15.2 cm)**

- 10-4269
- 10-4270 blue electro coating



10-4269



10-4270

**McGannon Retractor**

**Fenestrated blade / 5" (12.5 cm)**

- 205-800 2.5 mm



205-800

**Desmarres Lid Retractor Titanium**

**10 mm / 4 3/4" (12.1 cm)**

- T10-4198



T10-4198

**Double-ended / 10 mm & 12 mm / 5 7/8" (14.7 cm)**

- T10-4255 6 mm



T10-4255

**Desmarres Lid Retractor Autoclavable Plastic**

**Double ended / transparent yellow / autoclave safe / 5 1/2" (14 cm)**

- 10-4245 10 mm & 12 mm
- 10-4246 14 mm & 16 mm



10-4245



10-4246

**Gil-Vernet Desmarres Retractor**

**5 3/4" (14.5 cm)**

- 10-4211 size 1
- 10-4221 size 2
- 10-4231 size 3
- 10-4241 size 4



10-4211

10-4231



10-4221

10-4241



10-4241

**Chamberlain-Fries Retractor**

Aluminum handle / 7 1/2" (19 cm)  
475-882



475-882

**Lukens Thymus Retractor**

7" (18 cm)  
502-409



502-409

**Lukens Thymus Retractor**

Blue electro coated / 7" (18 cm)  
502-410



502-410

**Meyering Finger Retractor**

7" (18 cm)

- 205-856 style 1
- 205-857 style 2
- 205-858 style 3
- 205-859 style 4
- 205-860 style 5
- 205-861 style 6

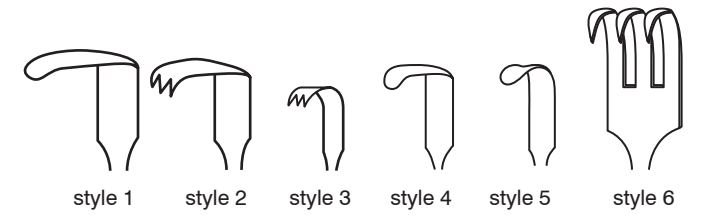

205-857



205-858



205-861

**Cottle Alar Retractor**

6 1/4" (16 cm)  
205-867



205-867

**Luer S-Shaped Retractor**

Double-ended / 10 x 5 mm & 14 x 9 mm  
/ 5 1/2" (14 cm)  
502-405



502-405

**Jackson Tracheal Retractor**

2 prong / blunt / 7" (18 cm)  
502-399



502-399

**Jackson Tracheal Retractor**

Blue electro coated / 2 prong / blunt / 7" (18 cm)  
502-400



502-400

**Perkins Retractor**

230-487 5 1/4" (13.5 cm) right  
230-488 5 1/2" (14 cm) left



230-487



230-488

**Mayo-Sontec Retractor**

6 3/4" (16 cm)  
1100-634 2 1/4" blade

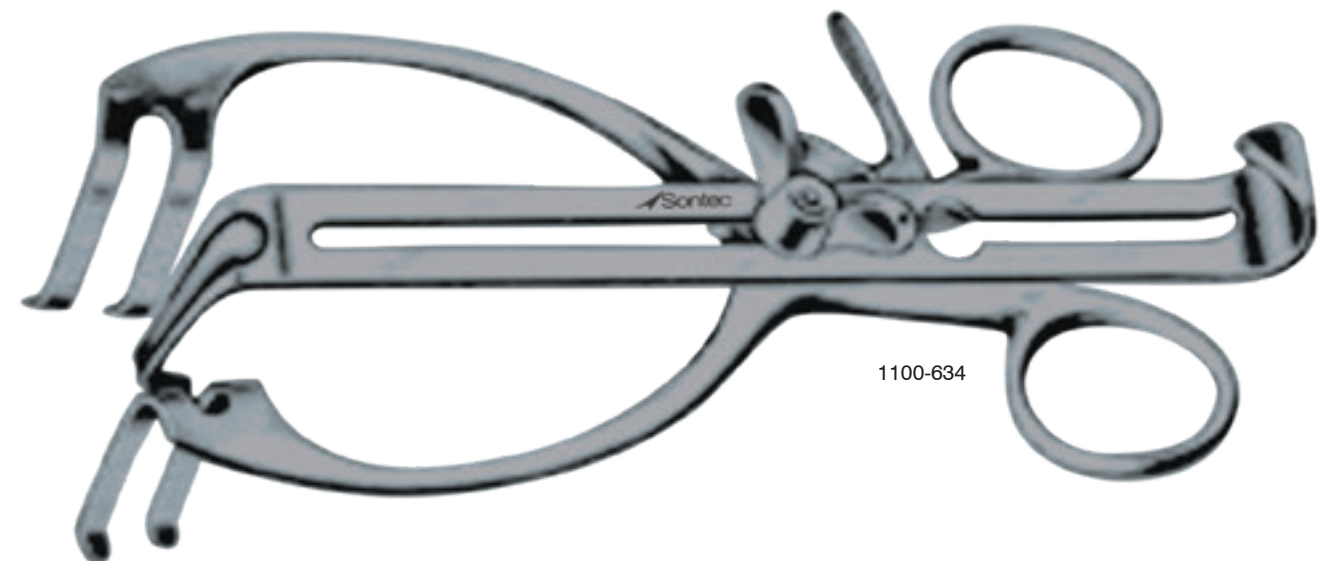

1100-634

**Plester Retractor Set**

**Blunt / 5 1/4" (13.3 cm)**

230-489R right  
230-489L left

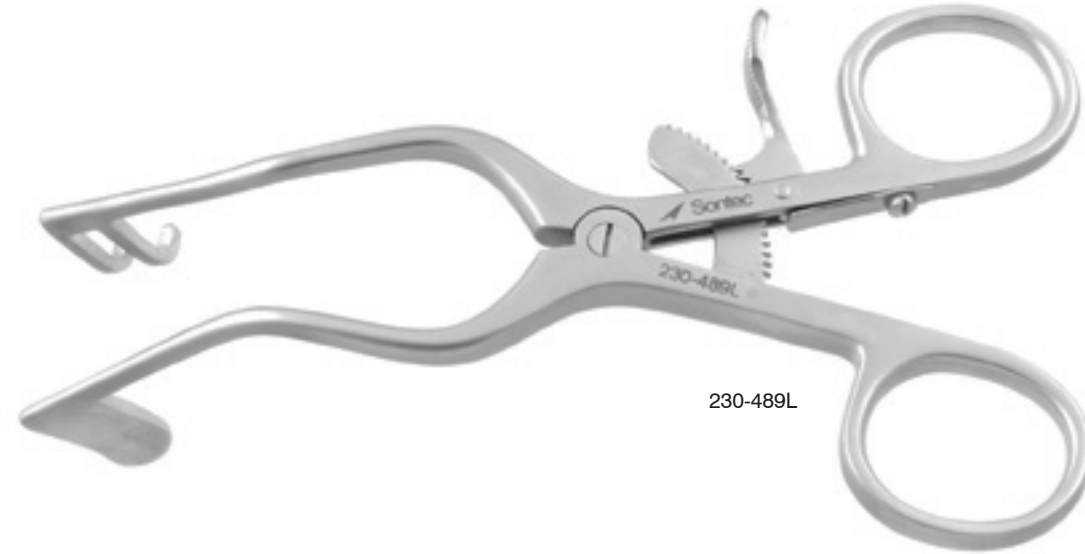

230-489L

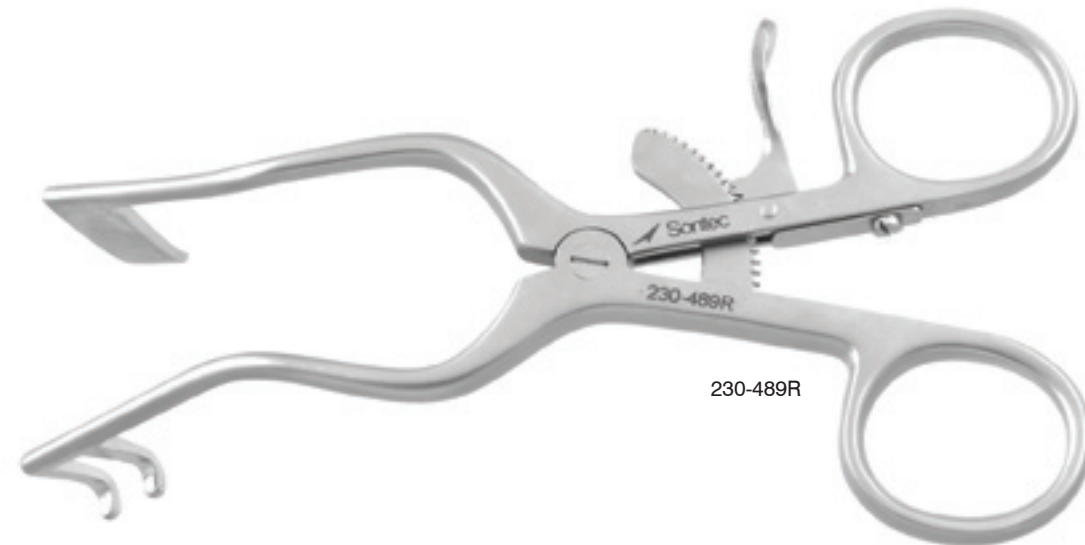

230-489R

**Jefferson Retractor**

**3x4 blunt 16 mm blades with curved arms / 5" (13 cm)**

230-495



230-495

**Plester Jansen Retractor**

**2x2 blunt 15 mm blades with curved arms / 4 3/8" (11 cm)**

230-4961

**3x3 blunt 20 mm blades with curved arms / 5 1/4" (13 cm)**

230-496



230-4961



230-496



 Sontec Instruments®

Plastic Endoscopic Face Lifting



**Ramirez Type Endoscopic Plastic Forehead Scissors**

Malleable / curved / vertical tip / 15 cm working length

- 2800-0001 periosteal
- 2800-0002 corrugator

Malleable / curved / horizontal tip / 15 cm working length

- 2800-0006 periosteal
- 2800-0007 corrugator



**Ramirez Type Endoscopic Plastic Forehead Procerus Punch**

Malleable / straight / vertical tip / 15 cm working length

- 2800-0003

Malleable / straight / horizontal tip / 15 cm working length

- 2800-0008



**Ramirez Type Endoscopic Plastic Forehead Corrugator Grasper**

Malleable / straight / vertical tip / 15 cm working length

- 2800-0004

Malleable / curved / horizontal tip / 15 cm working length

- 2800-0009



**Ramirez Type Endoscopic Plastic Facelift Needle Holder**

Malleable / straight / vertical tip / 15 cm working length

- 2800-0005

Malleable / straight / horizontal tip / 15 cm working length

- 2800-0010





 Sontec Instruments®

ENT RONGEURS

**Sontec Dynamic Punch Rongeur**

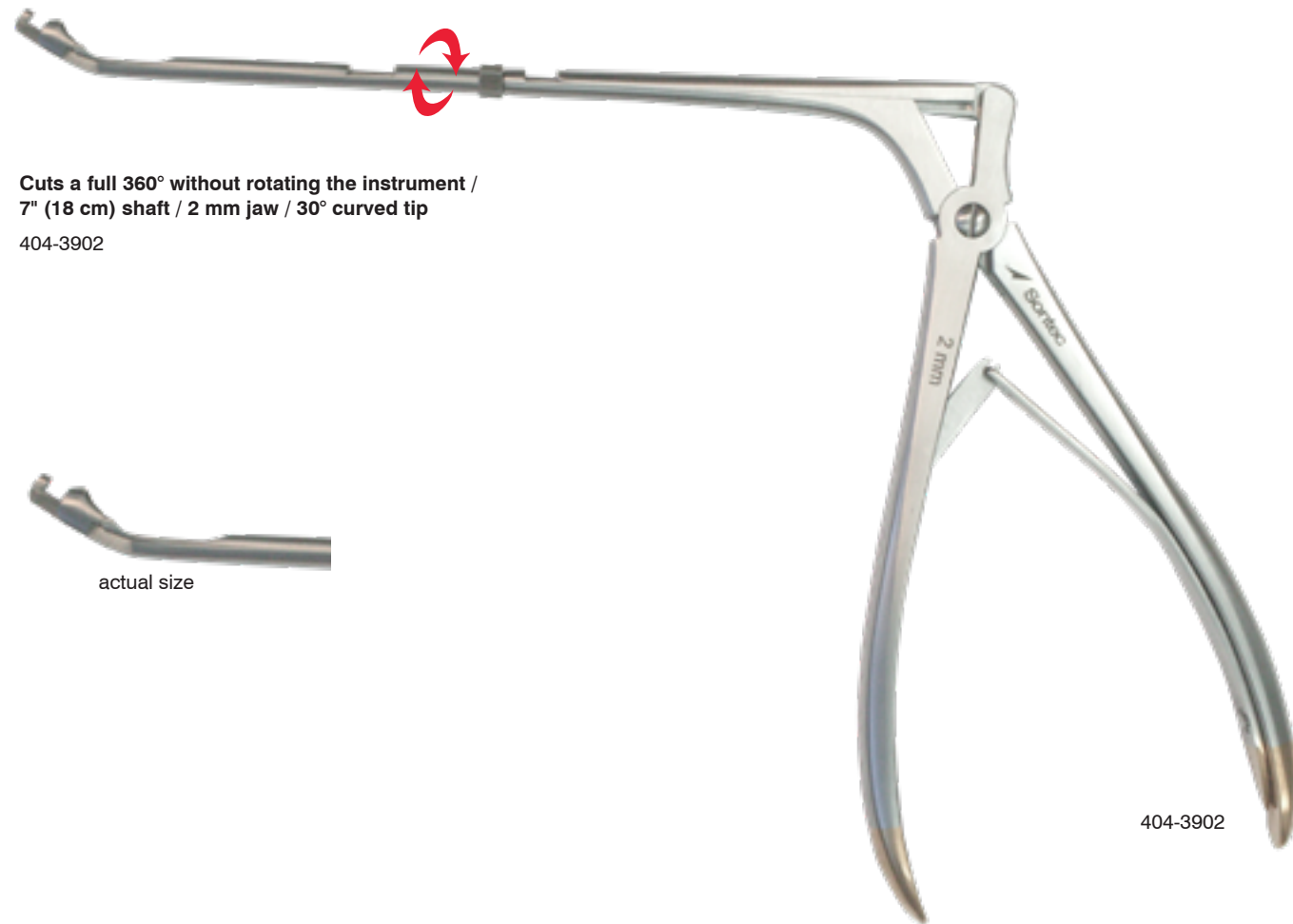

Cuts a full 360° without rotating the instrument /  
7" (18 cm) shaft / 2 mm jaw / 30° curved tip  
404-3902

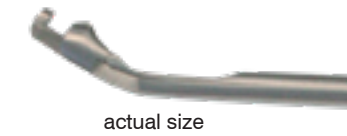

404-3902

**Hajek-Kofler Bone Punch Rongeur**



360° rotating shaft / 6 1/4" (16 cm) shaft  
404-390

404-390

**Frontal Ostium Nasal Rongeur**

70° curved up / 5 1/2" (14 cm) shaft  
468-010 2 mm x 2.5 mm jaw pediatric  
468-011 3 mm x 3.5 mm jaw  
468-012 5 mm x 5 mm jaw

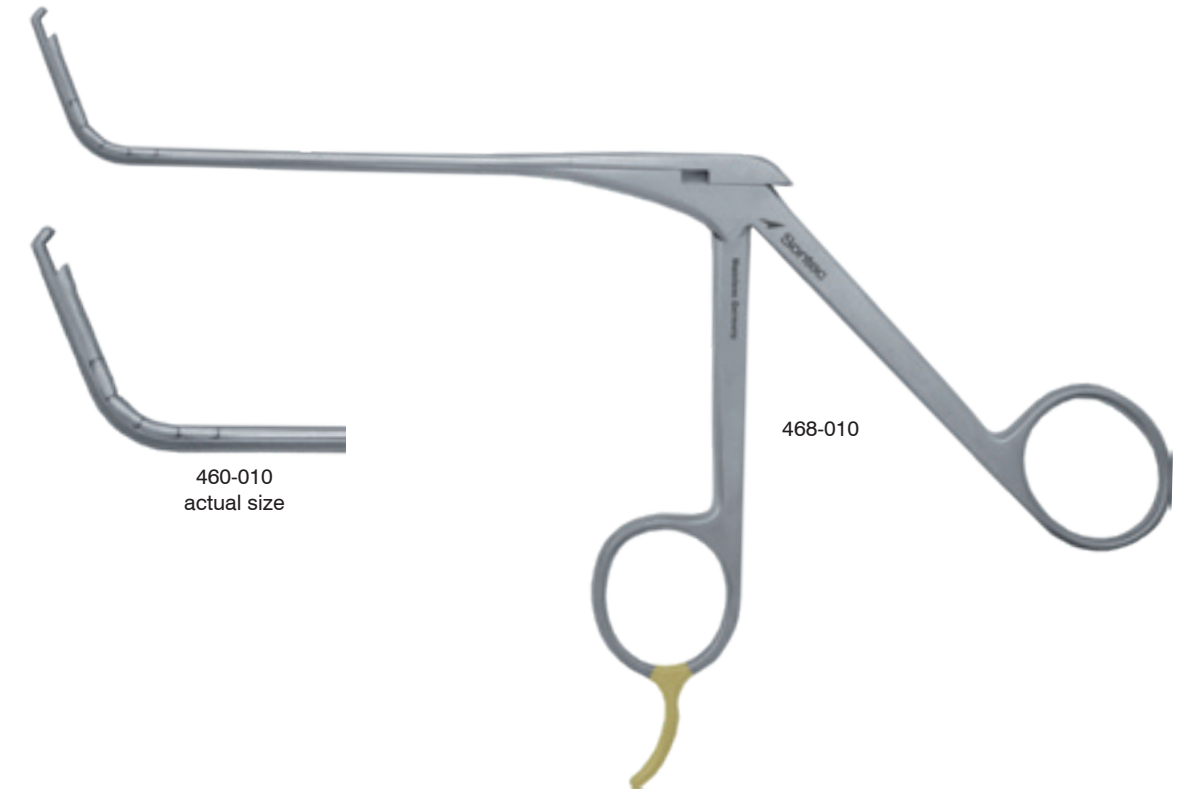

460-010  
actual size

468-010

**Lower Lateral Cartilage Morselizer**

7 1/2" (19.1 cm)  
468-515



468-515

**Weil Cut-Through Rongeur**

Fenestrated jaw / scissor action / straight / 4 1/2" (11.5 cm) shaft

- 468-649 2 mm x 5 mm jaw
- 468-650 2.5 mm x 5 mm jaw
- 468-651 3 mm x 5 mm jaw
- 468-660 3.6 mm x 8 mm jaw
- 468-670 4.8 mm x 14 mm jaw

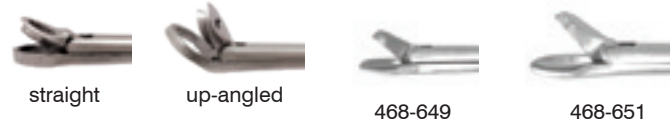

Fenestrated jaw / scissor action / up-angled / 4 1/2" (11.5 cm) shaft

- 468-654 2.5 mm x 5.5 mm jaw
- 468-664 3.6 mm x 8 mm jaw
- 468-674 4.8 mm x 13 mm jaw



**Jansen-Middleton Septum Rongeur**

5 mm x 15 mm spoon-shaped cups / 7 1/2" (19 cm)

- 475-340
- 475-345 ergonomic handle

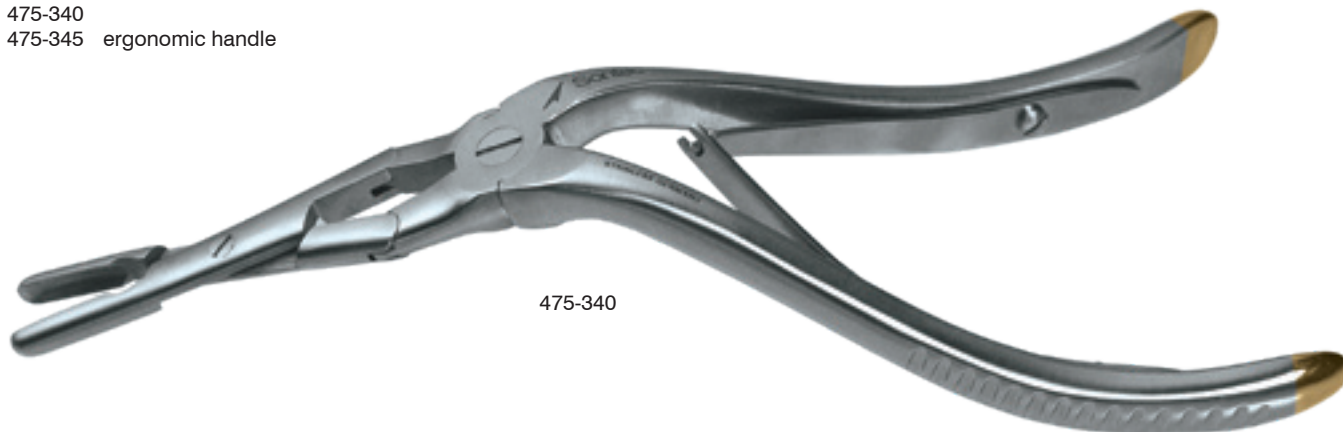

**Jansen-Middleton Septum Cut Through Rongeur Punch**

cut-through cups / ergonomic handle / 7 1/2" (19 cm)

- 475-350 4 mm x 19 mm
- 475-352 6 mm x 24 mm



**Sheen Fragment Retriever Forceps**



Low profile / 7" (18 cm)  
469-035

**Sontec Septal Platform Forceps**



7 1/4" (18.4 cm)  
467-332

**Classic Lempert Rongeur**

2.5 mm x 10 mm jaw

315-542	straight	6 1/4" (16 cm)
315-544	curved	6 1/4" (16 cm)
315-548	straight	7 1/2" (19 cm)
315-550	curved	7 1/2" (19 cm)

\* Additional Rongeurs available. Please call for styles, sizes & details



**Beyer Rongeur**

Double-action / curved / 7" (18 cm)

315-597	2.3 mm jaw
315-598	3.0 mm jaw
315-599	4.0 mm jaw

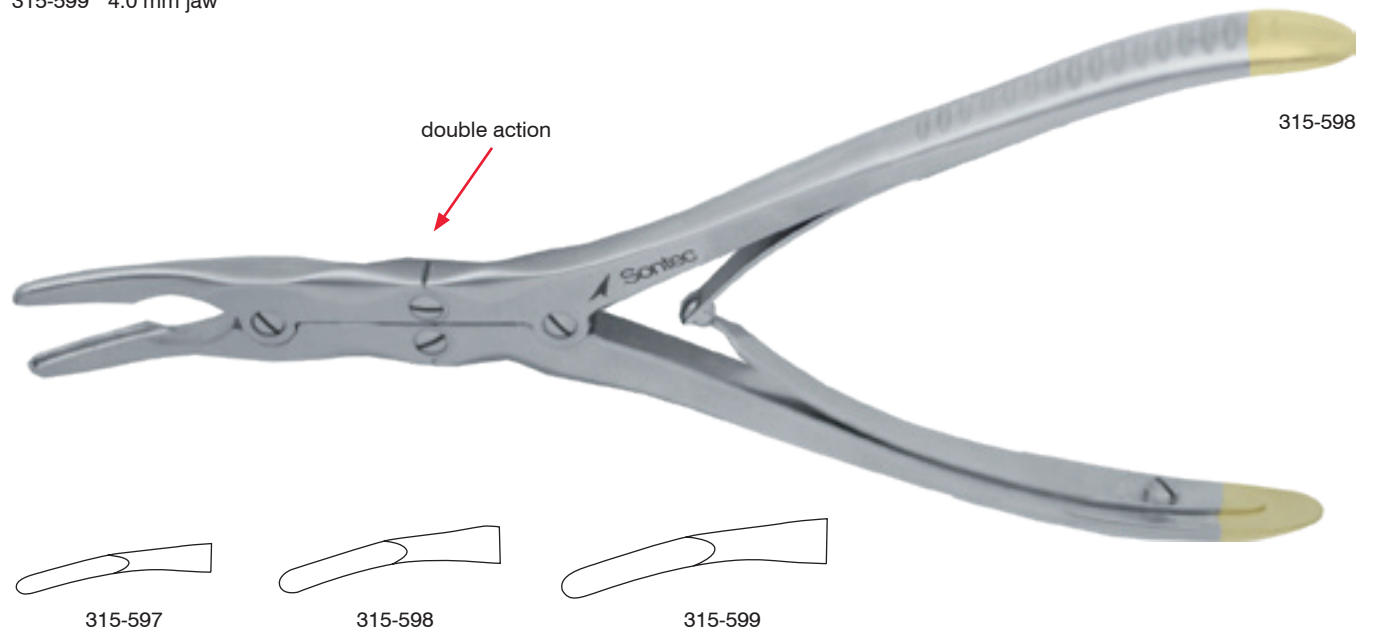

**Takahashi Rongeur**

**2.5 mm x 10 mm jaw cup / straight**

- 404-786 3 1/2" (9 cm) shaft
- 404-787 4 1/2" (11.5 cm) shaft
- 404-788 5 1/2" (14 cm) shaft

**3 mm x 10 mm jaw cup / 4 1/2" (11.5 cm) shaft**

- 404-788U up-angled
- 404-7871 straight

**3 mm x 8 mm oval jaw cup / straight**

- 404-7885 5 1/2" (14 cm) shaft

**3.5 mm x 10 mm jaw cup / straight**

- 404-7875 4" (10 cm) shaft



404-788U



404-7871



404-7875

**McIlwraith Cup Rongeur**

**Round cup / straight / 7" (18 cm) shaft**

- 1404-845A 2 mm cup
- 1404-845B 4 mm cup
- 1404-845D 6 mm cup

**Round cup / up-angled / 7" (18 cm) shaft**

- 1404-846A 2 mm cup
- 1404-846B 4 mm cup
- 1404-846D 6 mm cup



1404-846D



1404-845A

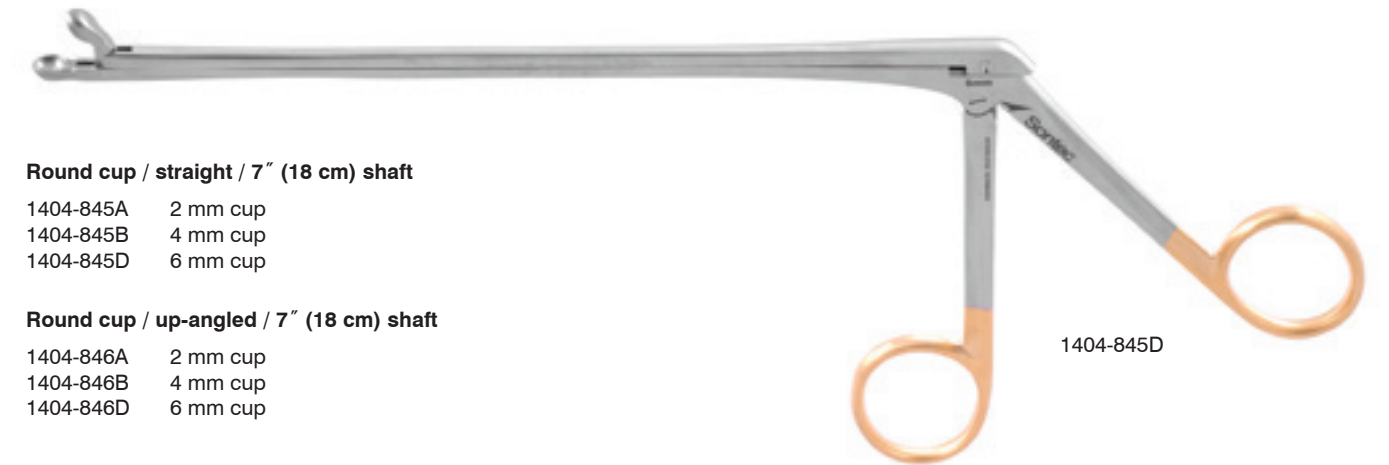

1404-845D

**Sheen Fragment Retriever Forceps**

**Low profile / 7" (18 cm)**

- 469-035



469-035



 Sontec Instruments®

ENT KNIVES

**McIlwraith Bistouri Knife**

**Button end blade**

- 1271-156 straight 35 mm 6" (15 cm)
- 1271-155 curved 55 mm 7" (18 cm)
- 1271-154 straight 55 mm 7" (18 cm)



1271-156



1271-155



1271-154

**Tendon Knife**

**6" (17 cm) / double Sided / 21mm blade**

- 1271-151 curved



1271-151

**Sexton-Gerzog Ear Knife**

**6 3/4" (17.1 cm)**

- 467-450 straight shaft
- 467-452 bayonet shaft
- 467-454 angle shaft



467-452

**Politzer Ear Knife**

**7 1/4" (18 cm)**

- 467-458 straight shaft
- 467-460 bayonet shaft
- 467-462 angled shaft



467-462



467-460

**Nasal Sickle Knife**

**6 1/4" (16 cm)**

- 467-461 straight small blade 3 x 1mm
- 467-465 light curve
- 467-467 straight



467-461



467-465



467-467

**Fisher Tonsil Knife**

**Serrated blade / 9" (22.9 cm)**

- 485-675



485-675

**Cottle Mucosa Knife**

**6" (15 cm)**

- 412-559



412-559



**Rosen Circular Blade Dissector**

6 1/4" (15.9 cm) / 45° angle tip

- 412-455 1.0 mm
- 412-456 1.4 mm
- 412-457 1.6 mm
- 412-458 2.0 mm
- 412-459 2.6 mm
- 412-460 2.8 mm
- 412-461 3.0 mm

6 1/4" (15.9 cm) / 90° angle tip

- 412-462A 1.5 mm
- 412-462B 2.0 mm
- 412-462C 2.5 mm
- 412-462D 3.0 mm



412-460

**Plester First Incision Knife**

6 1/4" (16 cm)

467-463



467-463

**Buck Myringotomy Knife**

6" (15 cm)

- 467-464
- 467-464A 90° angle



467-464

**Freer Mucosa Knife**

6 1/4" (16 cm)

345-405



345-405

**Jacobson Knife**

Micro blade / 6 1/2" (16.5 cm)

400-418



400-418

**Pashley Knife Set**

Curved blade / 6 3/4" (17 cm)

- 1467-456 straight
- 1467-460 angled right
- 1467-458 angled left



1467-458

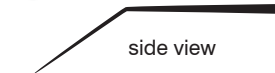

side view



1467-460

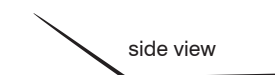

side view



1467-456



side view

**Yasargil Arachnoid Knife**

7 1/4" (18.5 cm)

- 400-426 full curved
- 400-427 partial curved bayonet



400-426



400-427

**Yasargil Bayonet Arachnoid Knife Titanium**

7 1/4" (18.5 cm)

- 400-427T curved down
- 400-4271T curved up



400-427T



400-4271T

**Ballenger Swivel Knife**

7 1/4" (18.5 cm)

- 467-5303 straight 3 mm
- 467-5304 straight 4 mm
- 467-5305 straight 5 mm

8 3/4" (22 cm)

- 467-5313 bayonet 3 mm
- 467-5314 bayonet 4 mm
- 467-5315 bayonet 5 mm



swivel end

467-5304

**Ballenger Bayonet Swivel Knife**

3 mm / 7 1/4" (18.5 cm)

467-534T



467-534T

**Joseph Tendon Knife**

6 1/2" (16.5 cm)

- 345-400 single edge 60° angled



345-400

**Joseph Nasal Knife**

Button end / straight / 6" (15 cm)

345-402



345-402

**Blair Skin Graft Knife**

W/ thickness gauge

- 199-600 6" (15 cm)
- 199-602 4" (10 cm)

Blades

- 199-604 blades for 6" (15 cm)
- 199-606 blades for 4" (10 cm)



199-600



199-604

**Skin Holding Plate**

4, 5, 8, 10 cm

475-950

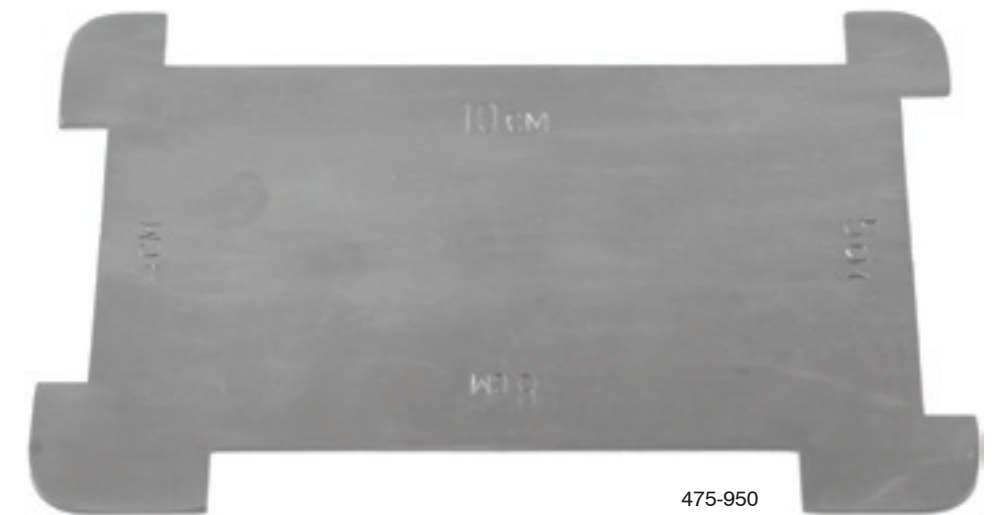

475-950



 Sontec Instruments®

CALIPERS & RULERS

**Castroviejo Caliper**

Scale to 20 mm / 3 1/2" (9 cm)

- 12-9300 str
- T12-9300 straight titanium
- 12-9310 cvd
- 12-9315 angled

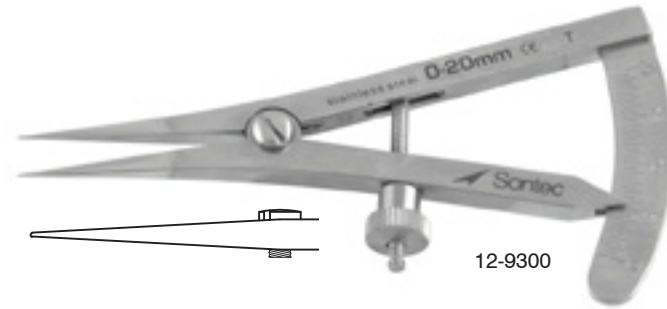

12-9300

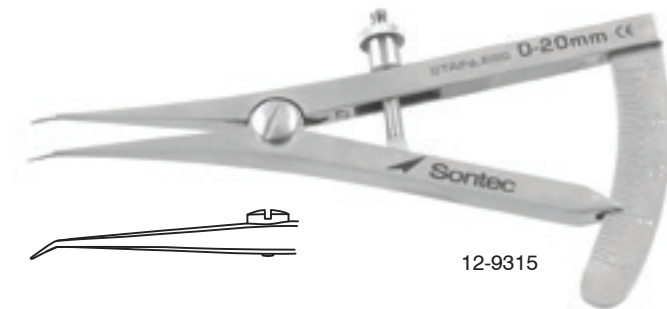

12-9315

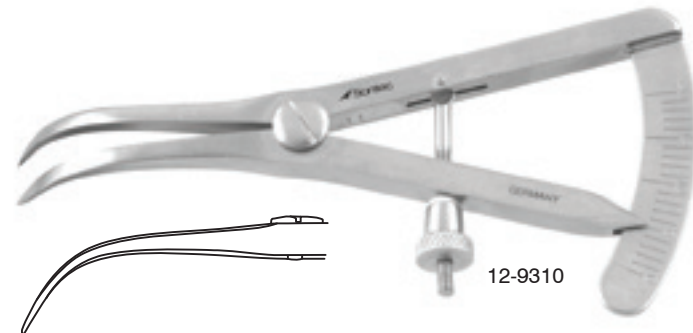

12-9310

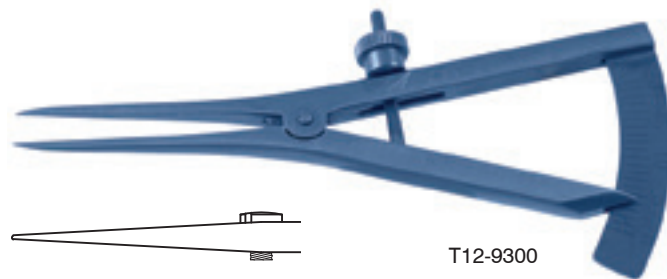

T12-9300

**Finger Goniometer**

5 3/4" (14.5 cm)

350-915

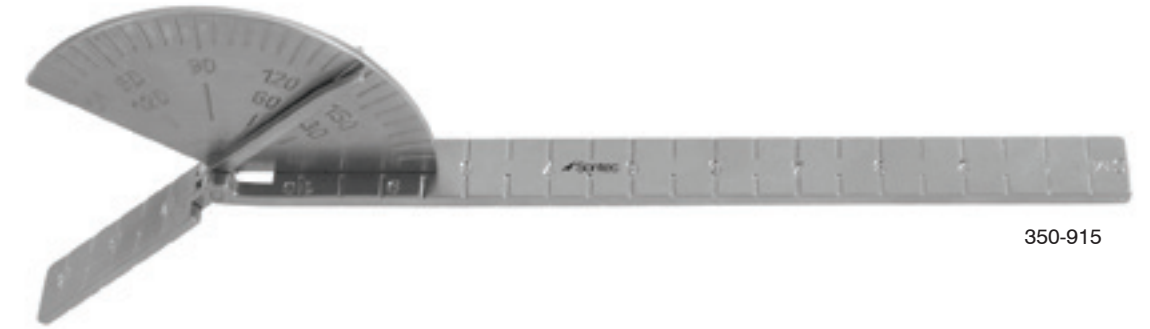

350-915

**Castroviejo Body Caliper**

0-200 mm gauge / 0-100 mm gauge

- 12-9330 100 mm
- 12-9335 200 mm



12-9330



12-9335

**Castroviejo Caliper**

Straight / 40 mm / 7" (17.8 cm)

12-9320



12-9320

**Jameson Caliper**

Scale to 3" (8 cm)  
12-9450

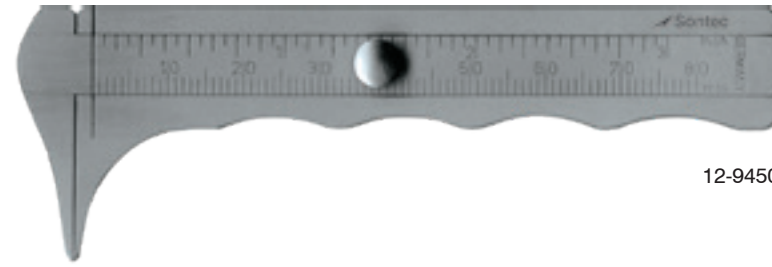

12-9450

**Thorpe Caliper**

Scale to 3" (8 cm) /  
angled / markings in  
0.5 mm increments  
12-9400



12-9400

**Orthopedic Vernier Caliper**

Stainless steel / 6" (15.5 cm)  
1103-170

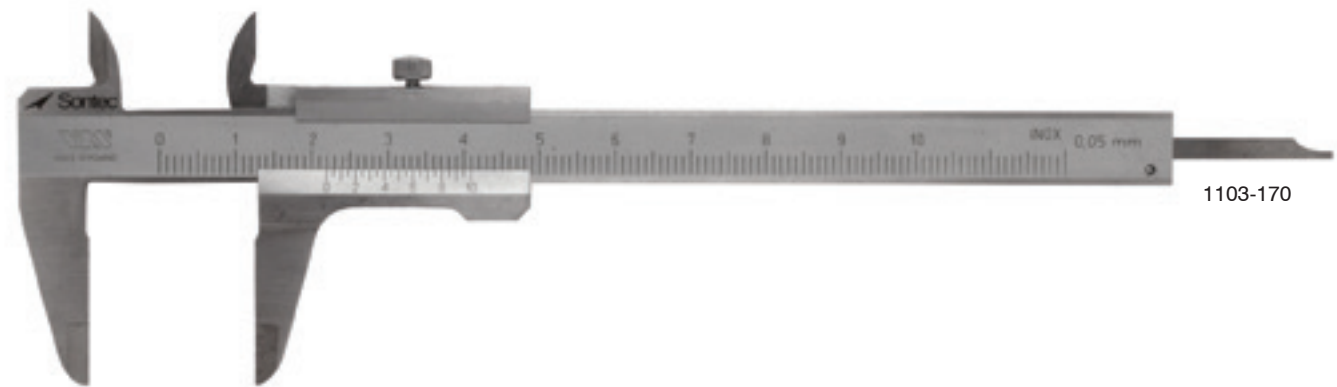

1103-170

**Braun Fixed Caliper**

8 cm / special sizes made to order  
12-9340

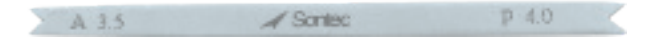

12-9340

**Stahl A/C Lens Gauge**

For verifying diameter of A/C  
lenses in 1.5 mm increments /  
Teflon coated stainless steel  
12-9630

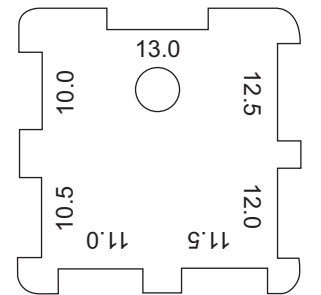

12-9600

**Stahl Caliper**

A/C caliper for  
measuring corneal  
diameter prior to A/C  
IOL / size markings  
on both sides  
12-9600



12-9630

**House Ear Caliper**

With rod mark / 6 1/4" (16 cm)  
1463-140 3.5mm  
1463-141 4mm  
1463-142 4.5mm  
1463-143 5mm

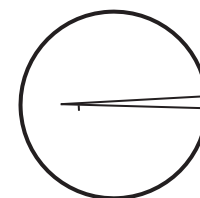

1463-142

**Schiotz Tonometer**

Autoclavable / original model  
18-8301 incline scale

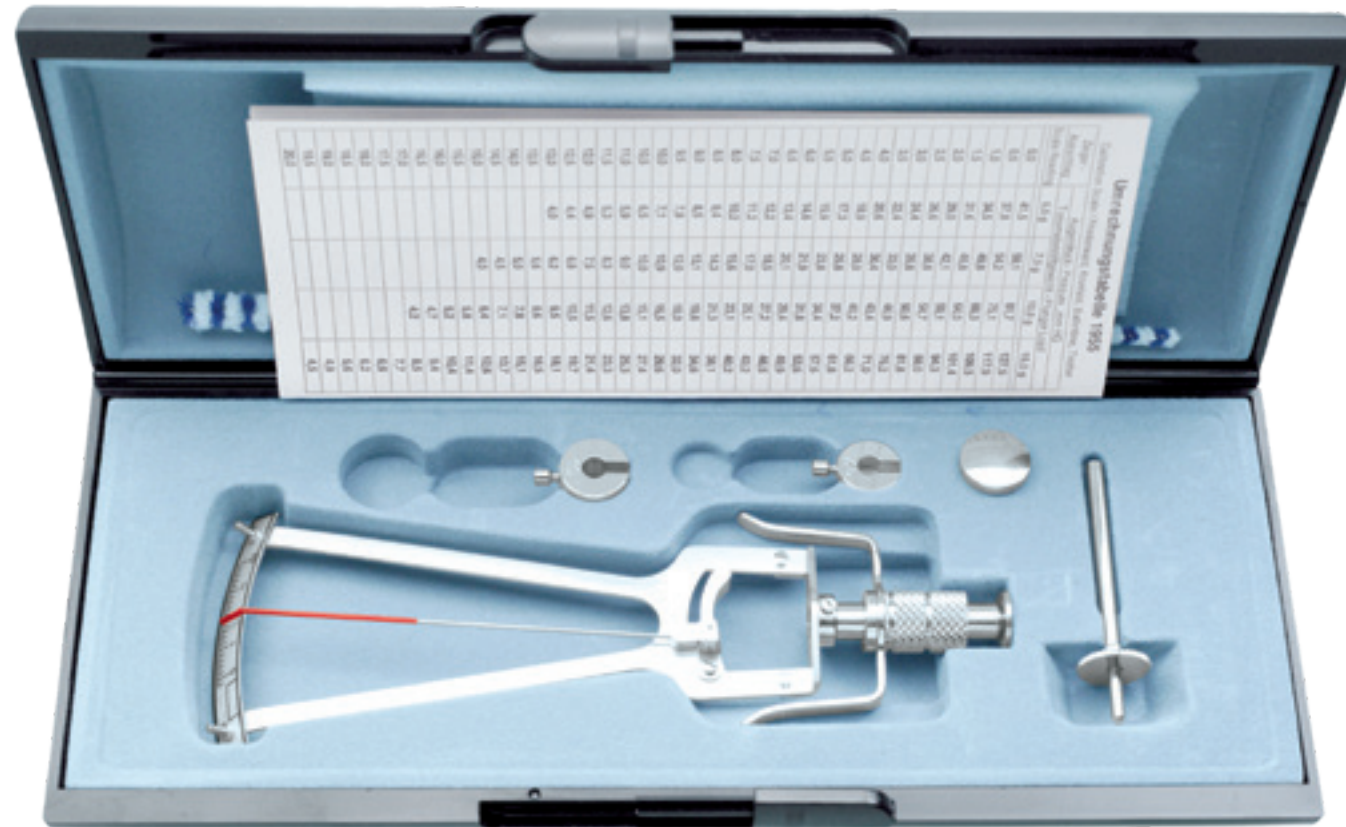

**Flexible Stainless Ruler**

6" (15 cm) / graduated in 1/32"  
fractions and millimeters  
12-9500

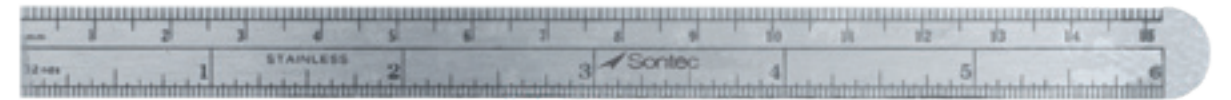

12-9500

**Punched Hole Gauge Ruler**

7" (18 cm) in length  
1106-190

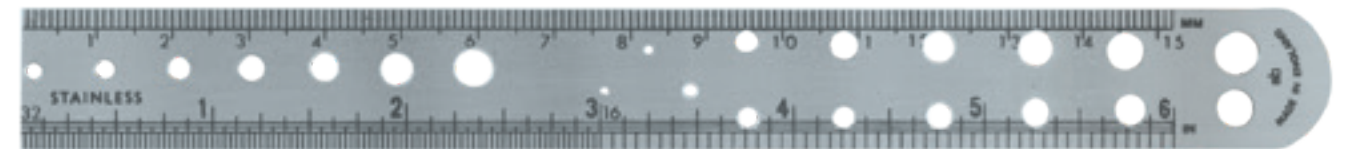

Back

1106-190



 Sontec Instruments®

RASPS

**Sontec®-Glabella Sculpting TC Insert Rasp**

TC / 7" (18 cm)  
345-246



345-246

**Webster Glabella Sculpting Rasp**

TC serrated tip / 4 mm x 8 mm / 8 1/4" (21 cm)  
345-246A



345-246A

**Foman TC Insert Rasp**

TC / double-ended / single-sided / 8 1/2" (21.5 cm)

- 345-289 9 / 10
- 345-287 7 / 8
- 345-285 5 / 6
- 345-283 3 / 4
- 345-281 1 / 2



345-285

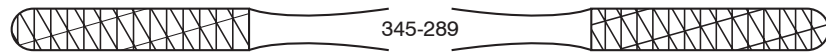

345-289

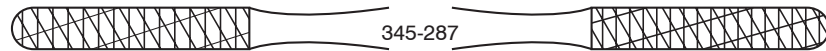

345-287

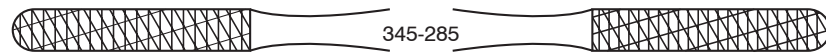

345-285

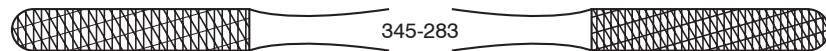

345-283

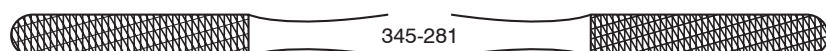

345-281

**Miller Rasp**

Concave / single  
ended / TC / 8"  
(20.25 cm)  
345-305



345-305

**Kistler Ear Cartilage Rasp**

Curved / 6 1/2" (16.5 cm)

- 475-618L left
- 475-618R right



475-618L



475-618R



**Rhinoplasty Rasp**

**Straight / 7 3/4" (20 cm)**

- 345-312 teeth down
- 345-314 teeth up



345-312



345-314

**Maltz Improved Double Ended Rasp**

**Single-sided / up & down rasping / 8 1/4" (21 cm)**

1103-235



1103-235

**McCollough Twist Fomon Raspatory**

**Double-Ended-Single-Ended / TC / 8 1/2" (21.6 cm)**

- 345-350 #2/3
- 345-352 #4/6



345-352

**Sontec Ear Rasp Set**

**Serrated / 6" (15.2 cm)**

- 475-596 curved left
- 475-598 curved right

**7 1/4" (18.5 cm)**

- 475-610 curved right
- 475-605 curved right serrated
- 475-600 curved left serrated
- 475-615 set of all three



475-596



475-598



475-610



475-605



475-600

**Foman Rasp**

Serrated / double ended / single sided / 8" (20.3 cm)

- 345-290 1 / 2
- 345-291 3 / 4
- 345-292 5 / 6
- 345-293 7 / 8
- 345-294 9 / 10



345-290



345-291



345-292



345-293



345-294

**Foman Rasp**

TC serrated / double ended / 9" (22.9 cm)

- 345-2951 #1
- 345-2952 #2
- 345-2953 #3
- 345-2954 #4
- 345-2955 #5
- 345-2956 #6
- 345-2957 #7
- 345-2958 #8
- 345-2959 #9
- 345-2950 #10



**Foman "R" Rasp**

Double ended / TC / 8 1/4" (21 cm)

- 345-279



345-279

**Polokoff Bone Rasp Double-Ended Single-Sided**

- 1103-241 5.5 mm / 6 mm 8"
- 1103-242 3 mm / 4 mm 7 1/2"



1103-241



1103-242

**Howard Bone Rasp Double-Ended Single-Side**

7 1/8"

- 1103-223 #12
- 1103-225 #12A
- 1103-226 #12CA



1103-223



1103-225



1103-226

**Miller Bone Rasp Double-Ended Single-Sided Serrated**

7"

- 345-241 5 mm / 6 mm #33
- 345-242 3 mm / 4 mm #64
- 1103-233 6 mm / 7 mm #10



**Miller Bone Rasp Double-Ended Single-Sided**

7 1/2"

- 1103-229 6 mm / 7 mm #45



**Miller Rasp**

Concave / single ended / TC / 8" (20.25 cm)

- 345-305



**Sontec-Miller TC Insert Rasp**

Double-ended / TC / 7 1/8" (18.25 cm)

- 345-300 serrated
- 345-302 cross-serrated



**Miller Cross Serrated Rasp**

Double-ended / cross-serrated / up & down rasping / 7 1/8" (18.25 cm)

- 1103-232 4 mm & 4 mm wide
- 1100-490C 5 mm & 6 mm wide
- 1103-225C 5 mm & 7 mm wide
- 1100-491 6 mm & 7 mm wide

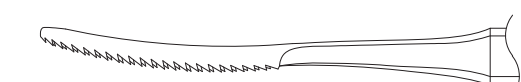
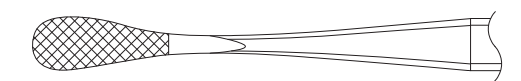
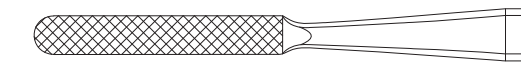
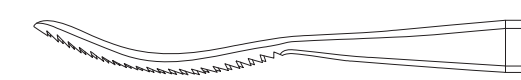
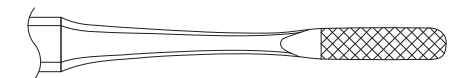
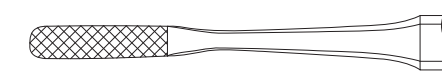

**Miller Parallel Serrated Rasp**

Double-ended / regular cut / down rasping  
/ 7 1/8" (18.25 cm)

- 1103-228 4 mm & 4 mm wide
- 1100-490 5 mm & 5 mm wide
- 1103-238 5 mm & 7 mm wide
- 1103-236 5 mm & 8 mm wide
- 1103-237 6 mm & 7 mm wide

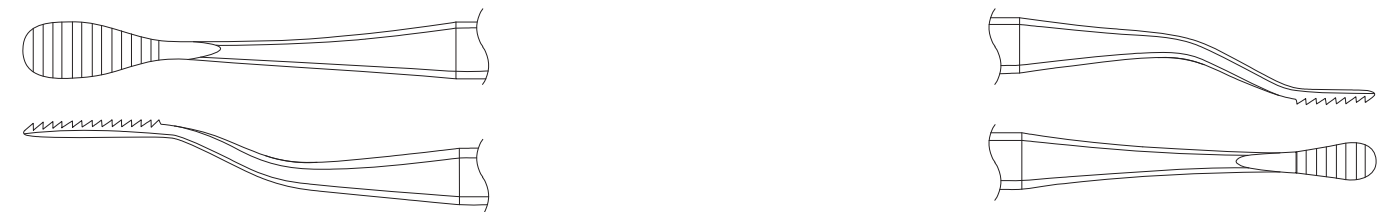

**Sontec Micro Rasp**

Single-ended / double-sided / 5 1/2" (14 cm)

- 345-265 straight
- 345-264 curved

Single-ended / single-sided / special order

- 345-266 5 1/2" (14 cm)
- 345-267 7" (18 cm)



**Nail Rasp**

Single-sided /  
6 3/4" (17 cm)

- 345-243



**Maltz Single-Ended Rasp**

Single-sided / 7" (18 cm)

- 345-310 reverse
- 345-311 forward cut



**Masing Rasp**

Single ended / straight  
/ TC / 7 3/4" (19.5 cm)

345-289R course  
345-338 fine



345-289R



345-338

**Sontec Diamond Surface Rasp**

7 3/8" (18 cm)

345-345 straight  
345-346 curved



345-345



345-346

**Sontec®-Glabella Sculpting TC Insert Rasp**

TC / 7" (18 cm)

345-246



345-246

**Webster Glabella Sculpting Rasp**

TC serrated tip / 4 mm x 8 mm / 8 1/4" (21 cm)

345-246A



345-246A

**Obwegeser Fenestrated Serrations Rasp**

Double-ended / flat, straight / infinity cut / 7 1/2" (19 cm)

345-320 fine grit  
345-322 medium grit



345-322

Double-ended / flat, curved / infinity cut / 7 1/2" (19 cm)

345-324 fine grit  
345-326 medium grit



345-326

Double-ended / concave / infinity cut / 7 1/2" (19 cm)

345-330 fine grit  
345-332 medium grit



345-332



 Sontec Instruments®

Plastic SPECIALTY

**Wright Fascia Needle**

With suture eye / sharp tip / 1 mm x 6 mm oval / 5 1/2" (14 cm)

10-4600



10-4600

**Cottle-Walsham Forceps**

For septum straightening / straight / 9" (24.5 cm)

468-520



468-520

**Midface Dissecting Forceps**

Curved / 9" (22 cm)

438-630 7 mm

438-632 10 mm

438-634 17 mm

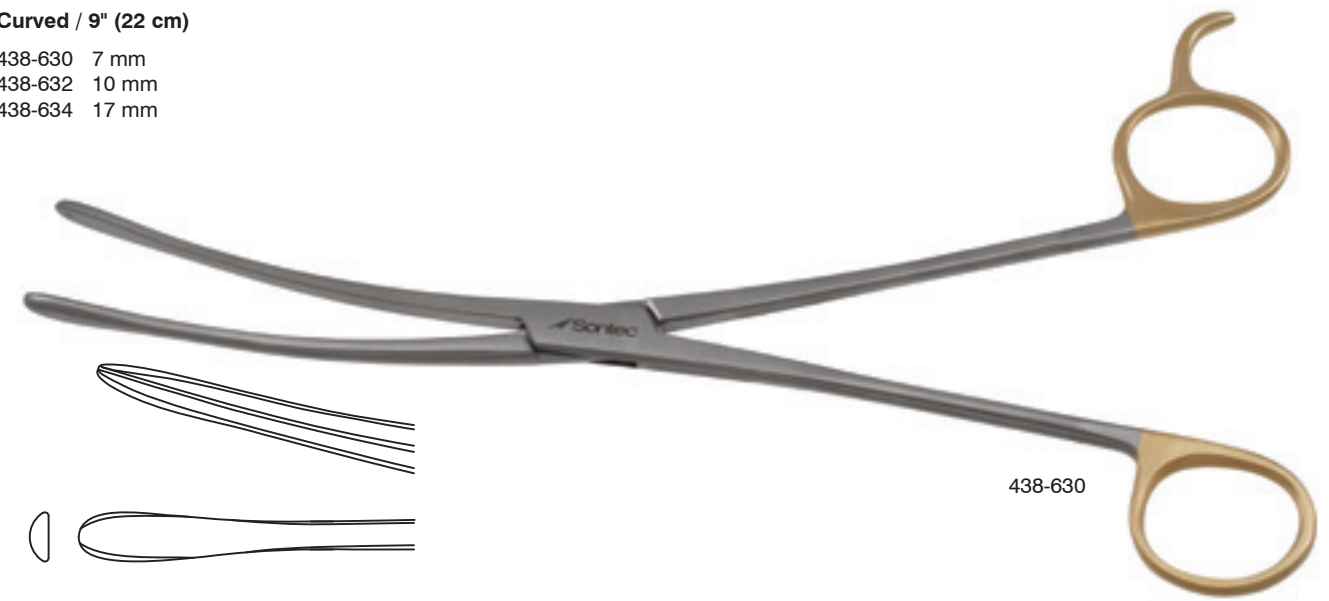

438-630

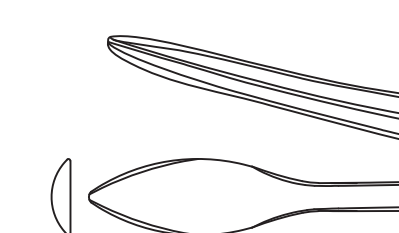
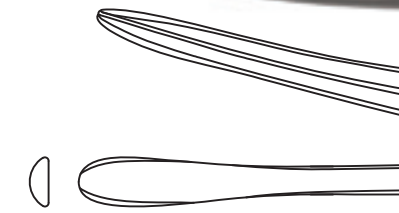

438-632

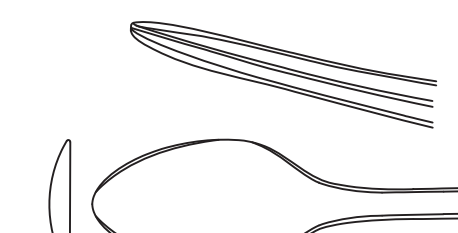

438-634

**Asch Septum Straightening Forceps**

Angled blades / 44 mm x 7 mm

468-522 9" (23 cm)

468-523 6 1/4" (16 cm)



468-523

**Tessier Bone Morselizing Forceps**

Concave/convex jaws / 8 3/4"  
468-521



468-521

**McCabe Facial Nerve Dissector**

Angle / smooth / 5 1/2"(14 cm)  
2200-437

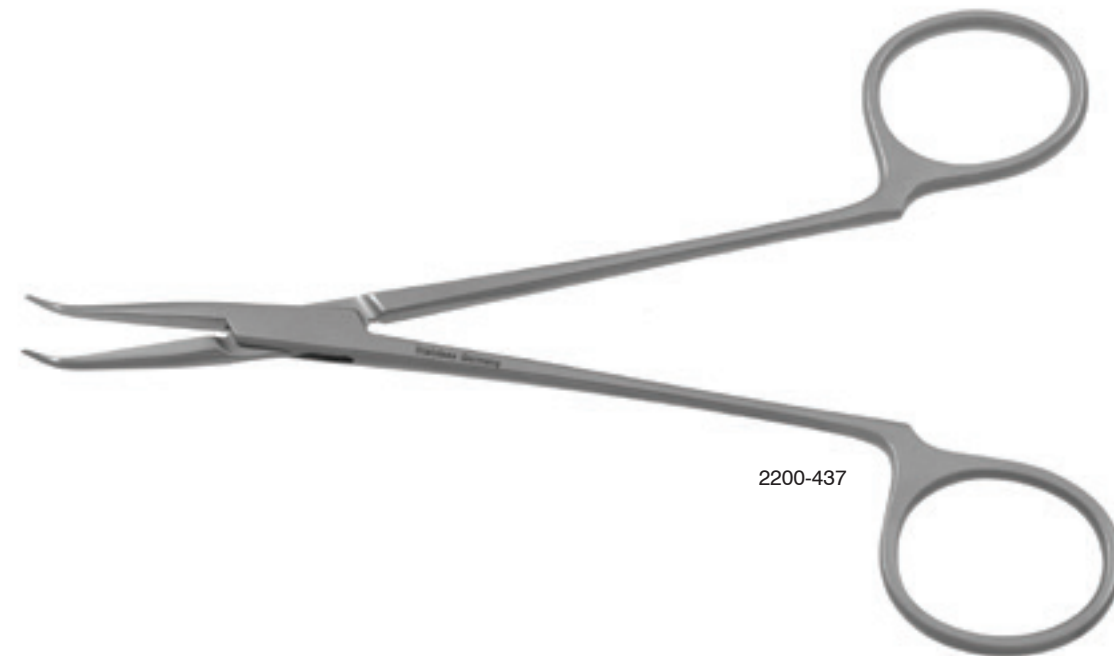

2200-437

**Rubin Septal Morselizer Forceps**

With jaw guard / 8"(20.5 cm)  
475-360

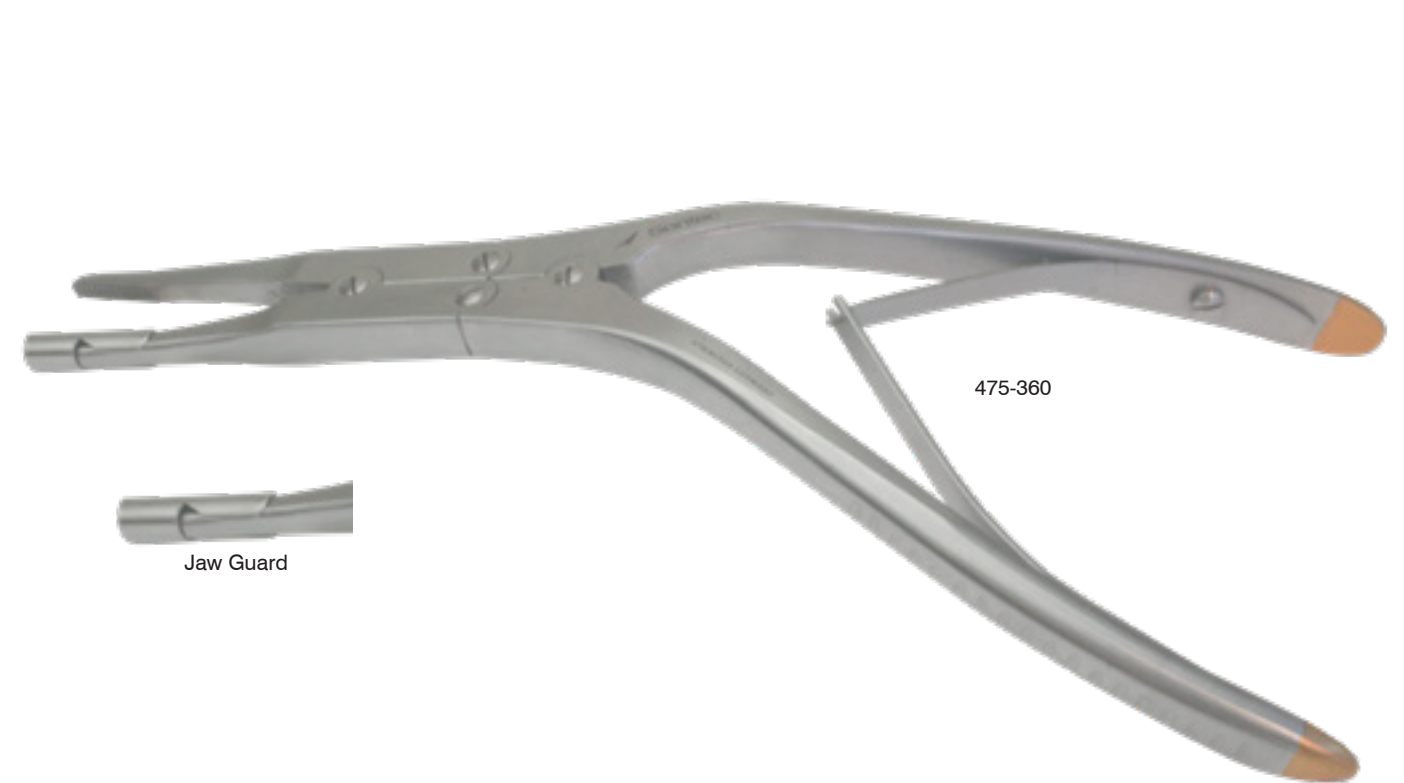

475-360

Jaw Guard

**Sontec® Universal Bottle Opener**

Easy to use / 7 1/2" (19 cm)  
1103-620



1103-620



**Freeman Areola Marker**

- 475-904 30 mm
- 475-899 34 mm
- 475-906 36 mm
- 475-900 38 mm
- 475-901 42 mm
- 475-902 45 mm
- 475-903 50 mm

- Sets
- 475-9071
  - Includes sizes: 36 mm & 42 mm
  - 475-9072
  - Includes sizes: 32 mm, 36 mm & 42 mm



**Sontec Areola Marker**

- 475-908 30 mm
- 475-909 34 mm
- 475-910 36 mm
- 475-911 38 mm
- 475-915 40 mm
- 475-912 42 mm
- 475-913 45 mm
- 475-914 50 mm



**Grossman Areola Marker**

- Aluminum / 4 sizes
- 475-917

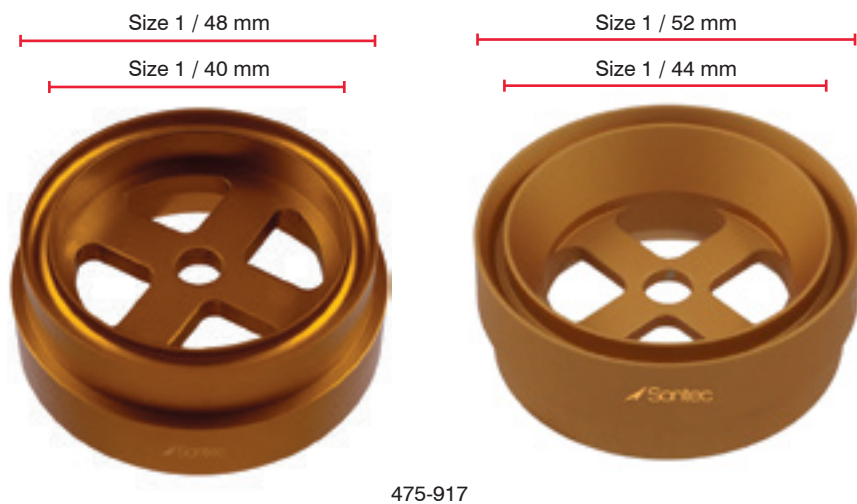

**Chang Quad Areola Marker**

- 38 mm & 42 mm
- 475-918



**Bone Grinder**

- 355-265



**Breast Reduction Marker**

- 475-916
- 475-916-SET
- 475-916S    small
- 475-916M    medium
- 475-916L    large

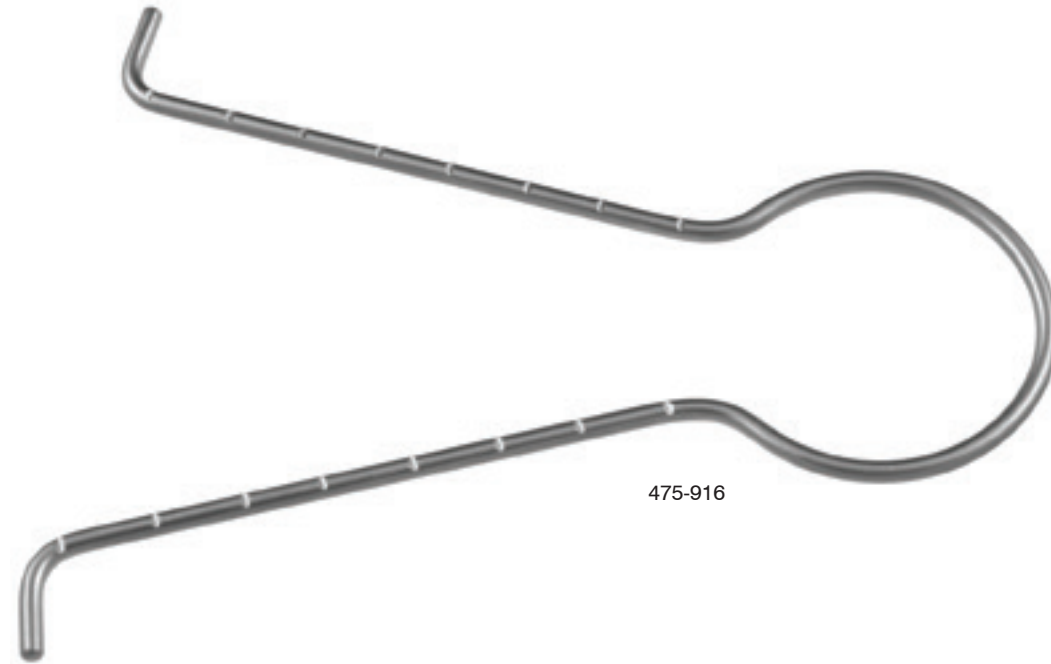

475-916

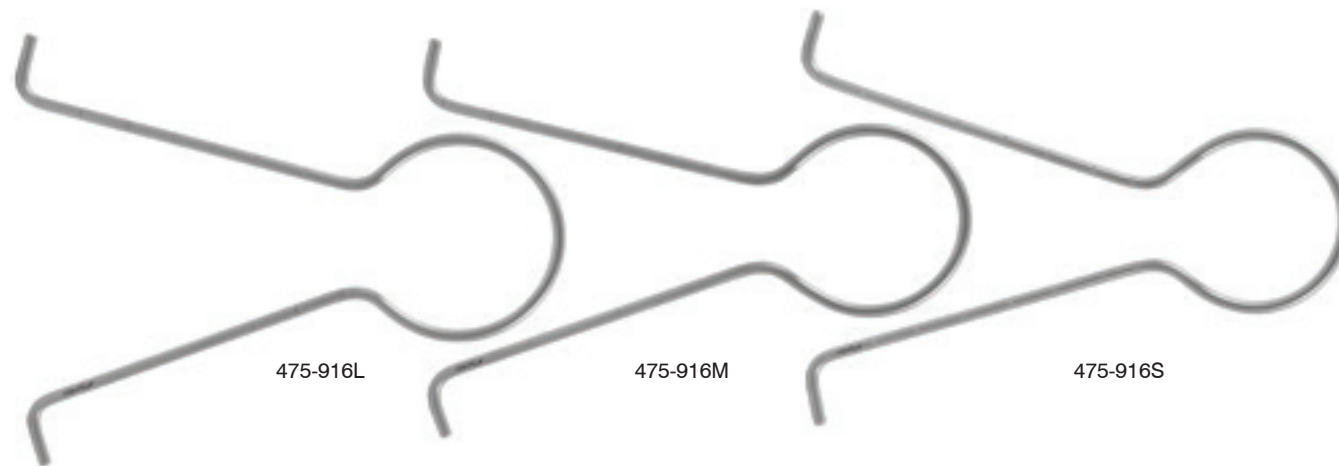

475-916L

475-916M

475-916S

**Lower Lateral Cartilage Morselizer**

- 7 1/2" (19.1 cm)
- 468-515



468-515

**Nasal Cartilage Punch Forceps**

- 6" (15 cm)
- 115-556



115-556

**Sontec Septal Platform Forceps**

7 1/4" (18.4 cm)  
467-332



**Sontec Septal Platform Forceps Titanium**

Serrated jaws / 11 mm x 21 mm / 7" (17.8 cm)  
469-033T



**Carroll Tendon Pulling Forceps**

4.5" shaft (11.4 cm) / serrated jaws  
350-805 curved down  
350-807 curved up

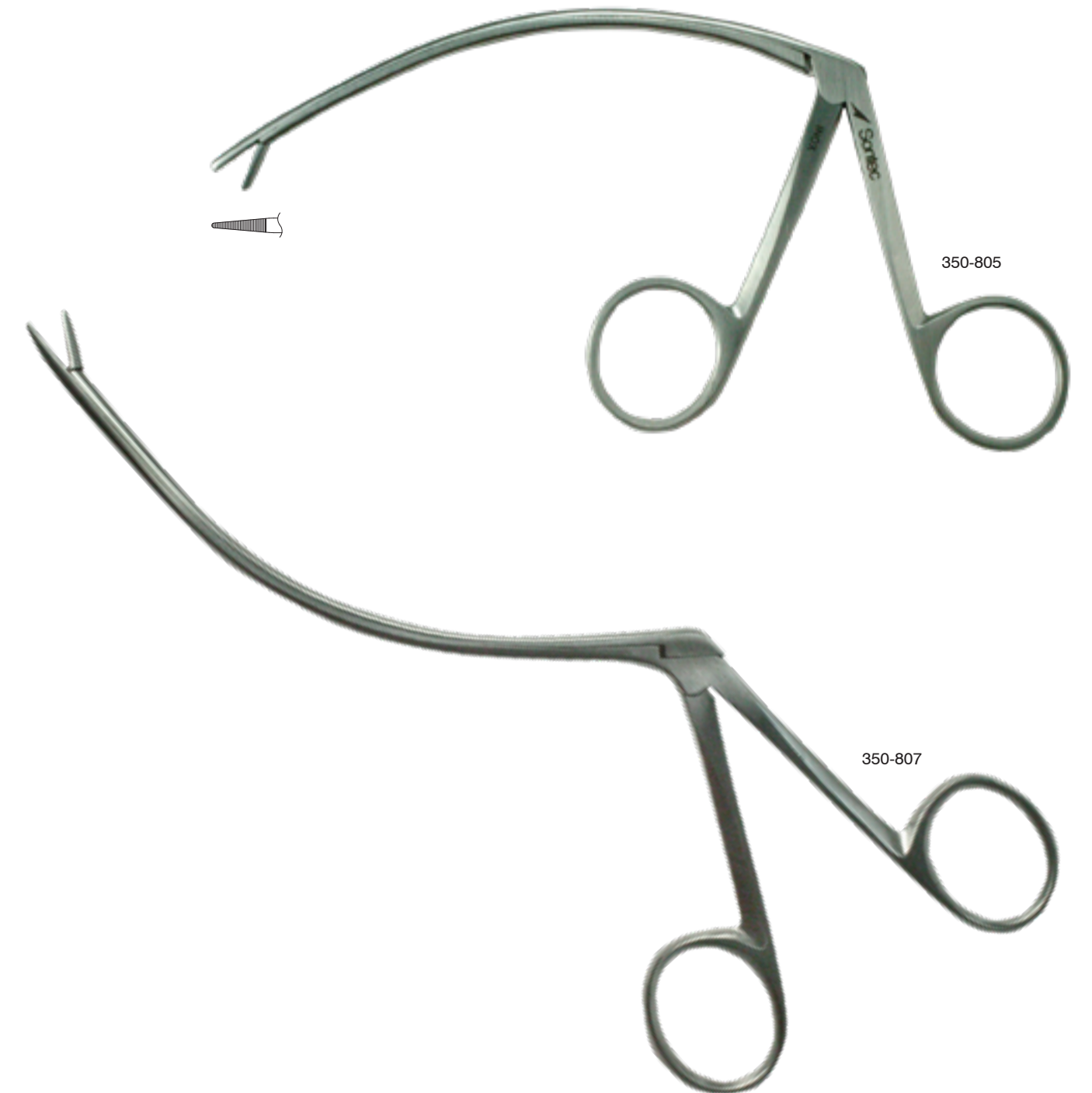

**Tendon Stripper**

4.5 mm / 9" (23 cm)  
350-790



350-790

**Sheehy Gelfoam Mini Cartilage Press**

7 1/2" (19.1 cm)  
468-535 12 mm x 16 mm plate  
468-530 13 mm x 13 mm plate

8 1/4" (21 cm)  
468-540 13 mm x 20 mm plate

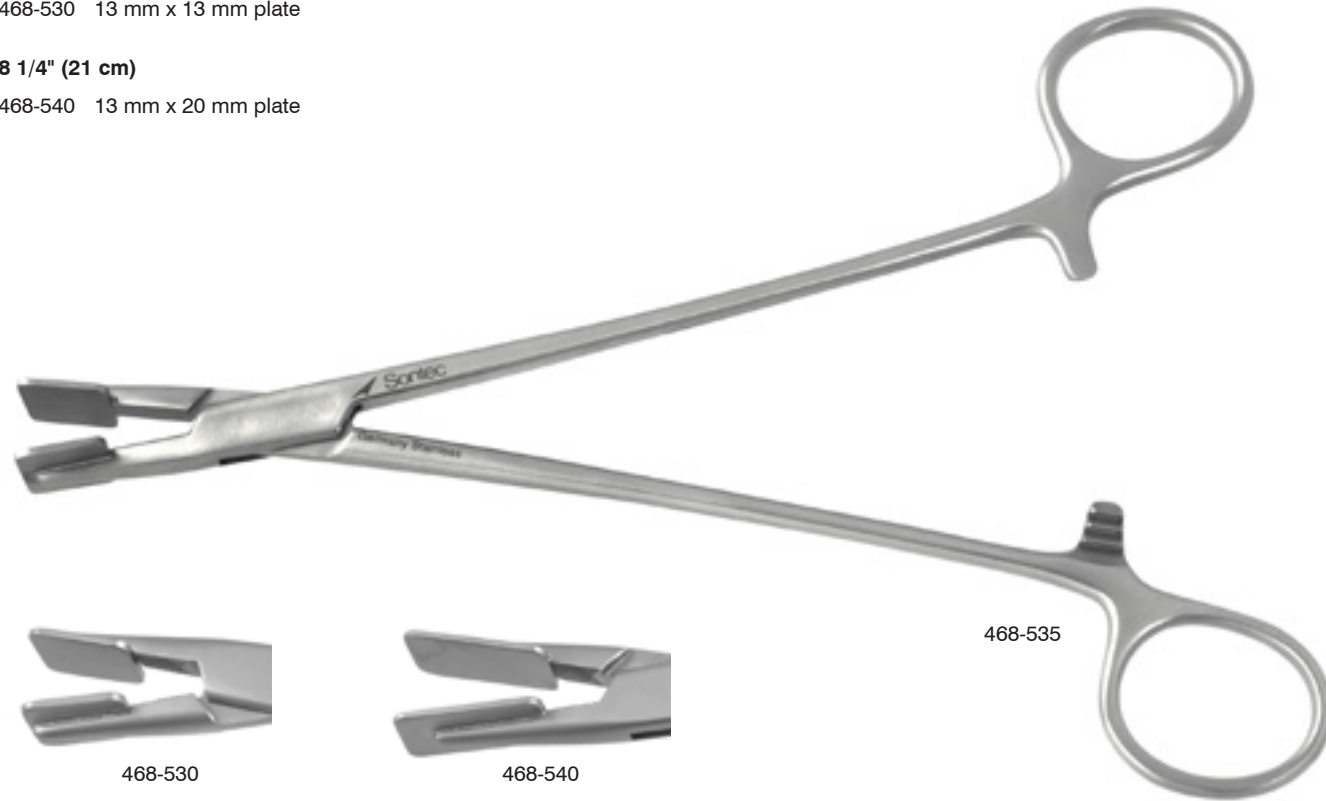

468-535

468-530

468-540

**Gubisch Cartilage Crusher**

350-851

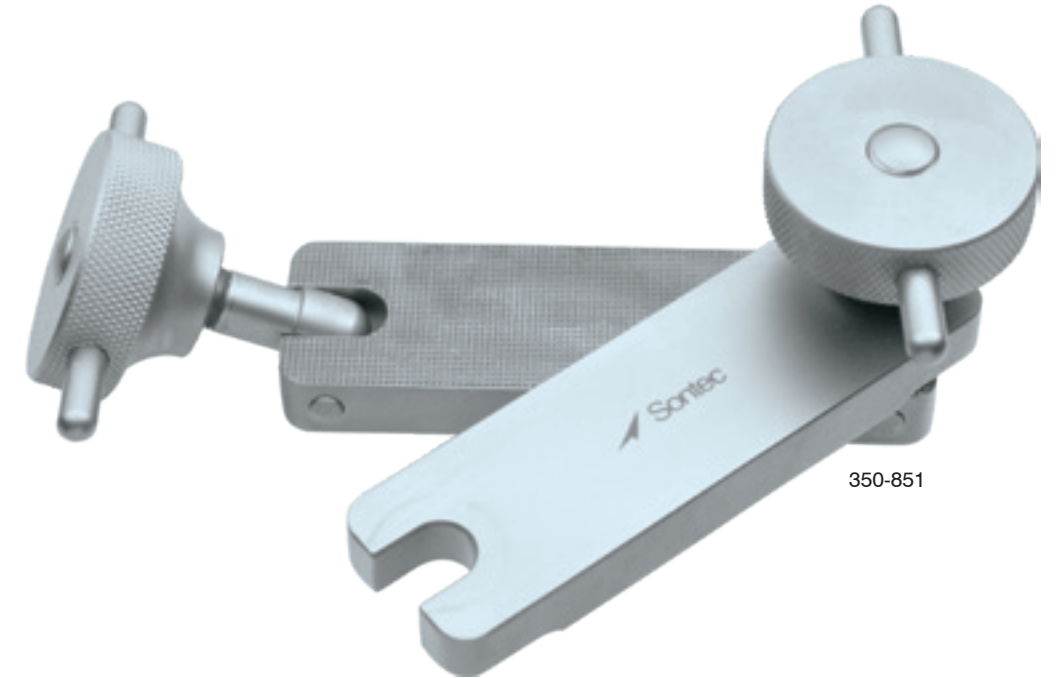

350-851

**Cartilage Cutting Block Titanium**

120mm x 120mm x 15mm  
350-5453



350-5453

**Cartilage Cutting Block**

85mm x 55mm x 10mm / 4 set depths to create the perfect cut

350-8451 teflon  
350-8451S stainless steel



350-8451



350-8451S

**Gruber Cartilage Teflon Cutting Block with Grid**

Black / 120 mm x 80 mm x 10 mm

350-8452



350-8452

**Gruber Teflon Cutting Block**

Without grid / 85 mm x 55 mm x 10 mm

350-8454



350-8454

**Sheen Cartilage Cutting Block with Grid**

Stainless steel / 120 mm x 80 mm x 2 mm

350-846

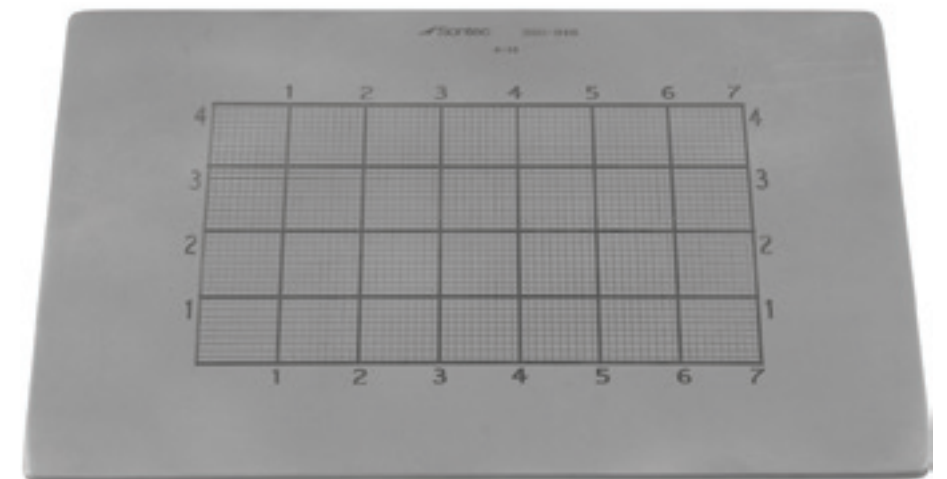

350-846

**Gruber Cartilage Cutting Block with Grid**

Stainless steel / 120 mm x 80 mm x 2 mm

350-845

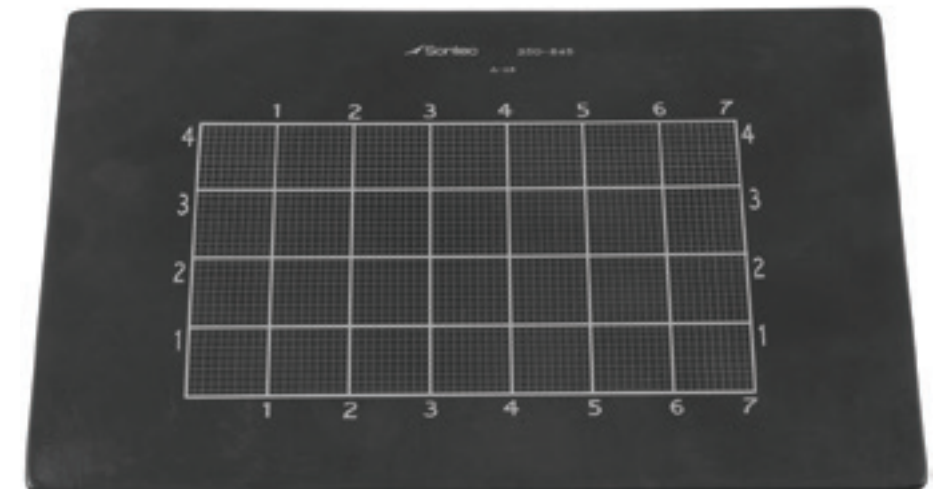

350-845

**Cottle Cartilage Crusher**

Original single serrated bed  
350-849

New / double-sided / dismountable /  
reversible / 1 smooth side 1 serrated side  
350-844

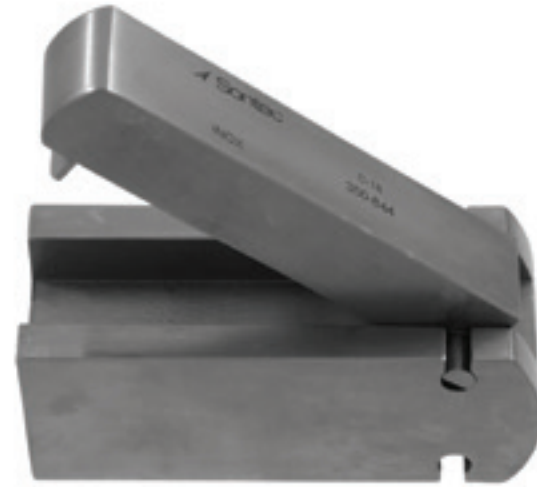

350-844 (side one)

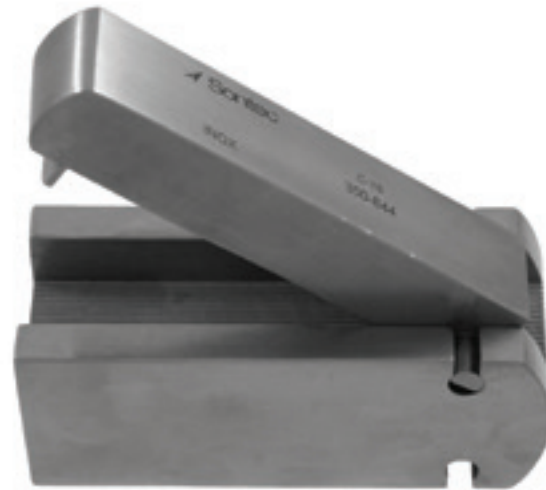

350-844 (side two)



350-849

**Cartilage Crusher**

Hand controlled crank / serrated bed  
350-850



350-850

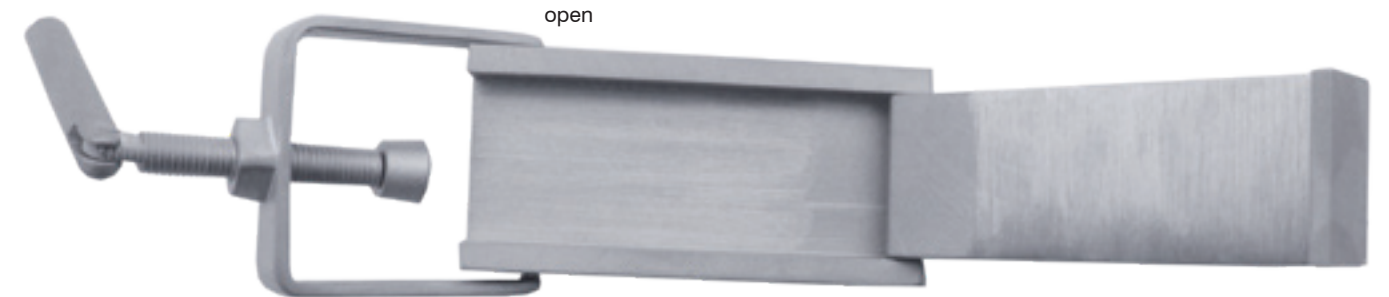

open



 Sontec Instruments®

Ligature Carriers

**Cassio Ligature Carrier**

Sharp / straight / 8" (20.5 cm)  
134-240

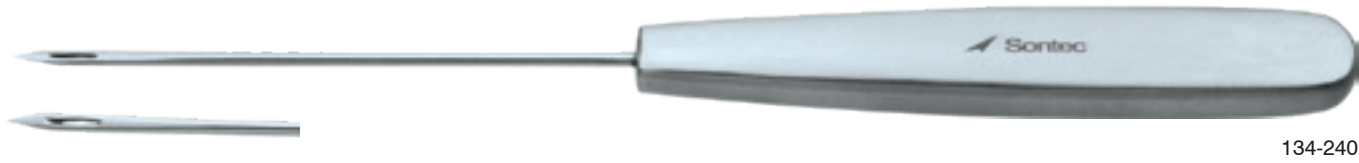

134-240

**Sontec Reverdin Blunt Needle/Ligature Carrier**

Blunt / curved / 8" (20.5 cm)  
134-242



134-242

**Reverdin Needle/Ligature Carrier**

Sharp / curved / 8" (20.5 cm)  
134-276



134-276

**Tendon Passer Ligature Carrier**

10.5" (26 mm) / 11" phenolic handle  
305-910



305-910

**Graft Passer Ligature Carrier**

**Curved**

1106-400	2 cm	extra small
1106-401	3 cm	small
1106-402	4.5 cm	large
1106-403	6 cm	extra large
1106-404	8cm	XX large



1106-400

1106-401

1106-402

1106-403



1106-400



**Deschamps Ligature Carrier**

**Small / 25 mm / 8" (20 cm)**

- 134-277 sharp left
- 134-278 sharp right
- 134-280 blunt left
- 134-281 blunt right



134-278

**Medium / 30 mm / 8" (20 cm)**

- 134-277M sharp left
- 134-278M sharp right
- 134-280M blunt left
- 134-281M blunt right

**Large / 35 mm / 9 1/2" (24 cm)**

- 134-282A sharp left
- 134-282B sharp right



134-277

**Schmieden-Dick Ligature Carrier**

**Malleable / 12 3/4" (32.5 cm)**

- 134-267



134-267

**Entner Ligature Carrier**

**Curved**

- 134-243 8.1/4" (21 cm)
- 134-245 6.1/2" (16.5 cm)



134-243

**Sanders Brown Ligature Carrier**

**10" (25 cm)**

- 134-248



134-248

**eyebrow Lifting Ligature Carrier**

**11" (28 cm)**

- 134-268



134-268

**Facia Ligature Carrier**

**6" (15 cm)**

- 134-247



134-247



 Sontec Instruments®

SUCTION Selection

**Frazier Angled Suction**

Finger cut-off hole to control suction / angled / 7" (18 cm)

- 412-677 3 french
- 412-678 4 french
- 412-680 6 french
- 412-681 7 french
- 412-682 8 french
- 412-683 9 french
- 412-684 10 french
- 412-685 11 french
- 412-686 12 french
- 412-688 15 french

9" (23 cm)

- 412-705 10 french



Finger cut-off hole to control suction / angled / malleable / 7" (18 cm)

- 412-677M 3 french
- 412-678M 4 french
- 412-680M 6 french
- 412-681M 7 french
- 412-682M 8 french
- 412-683M 9 french
- 412-684M 10 french
- 412-685M 11 french
- 412-686M 12 french
- 412-688M 15 french

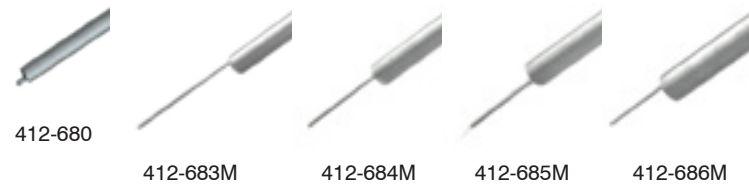

\* special order

Finger cut-off slot to control suction / angled / 7" (18 cm)

- 412-677L 3 french
- 412-678L 4 french
- 412-679L 5 french
- 412-680L 6 french
- 412-681L 7 french
- 412-682L 8 french
- 412-683L 9 french
- 412-684L 10 french
- 412-685L 11 french
- 412-686L 12 french



**Frazier Straight Suction**

Finger cut-off hole to control suction / straight / 7" (18 cm)

- 412-689 5 french
- 412-690 6 french
- 412-691 7 french
- 412-692 8 french
- 412-694 10 french
- 412-696 12 french

9" (23 cm)

- 412-700 6 french
- 412-701 7 french
- 412-702 8 french
- 412-704 10 french
- 412-706 12 french



**Frazier Insulated Suction**

Finger cut-off hole to control suction / angled / Insulated electro coated tube / 7" (18 cm)

- 412-677I 3 french
- 412-678I 4 french
- 412-679I 5 french
- 412-680I 6 french
- 412-681I 7 french
- 412-682I 8 french
- 412-683I 9 french
- 412-684I 10 french
- 412-685I 11 french
- 412-686I 12 french

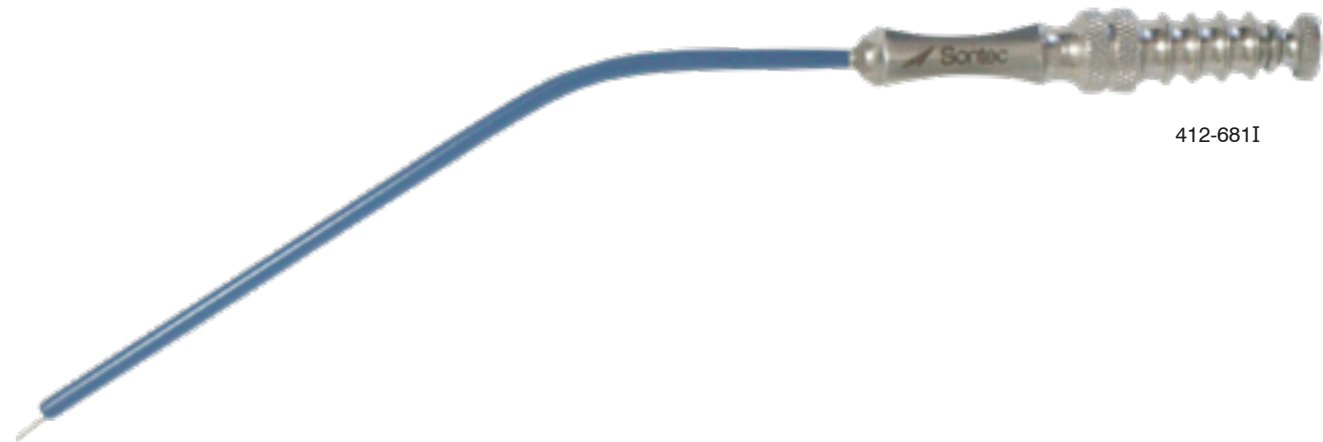

412-681I

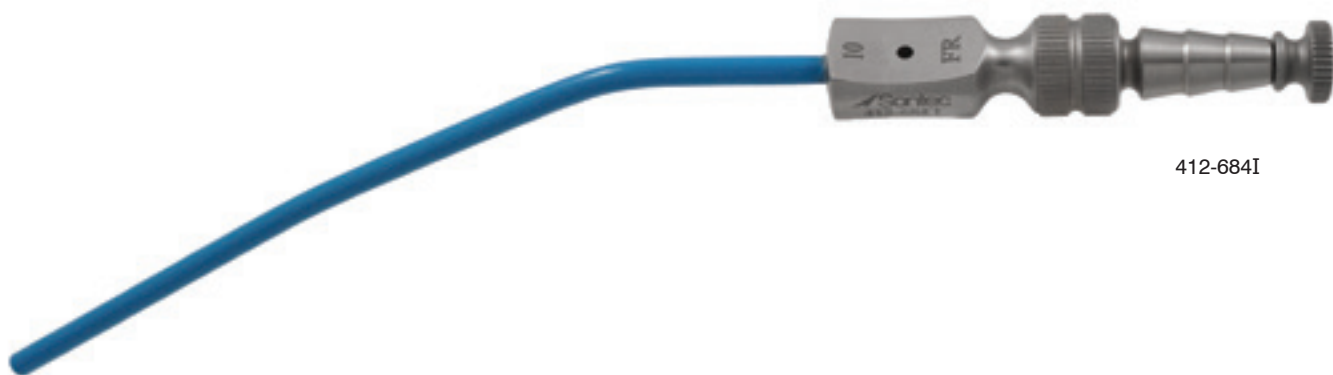

412-684I

**Fukushima Suction**

Tapered tube shaft / teardrop finger control / 7" (18 cm)

- 180-403 3 fr
- 180-404 4 fr
- 180-405 5 fr
- 180-406 6 fr
- 180-407 7 fr
- 180-408 8 fr
- 180-409 9 fr
- 180-410 10 fr
- 180-411 11 fr
- 180-412 12 fr

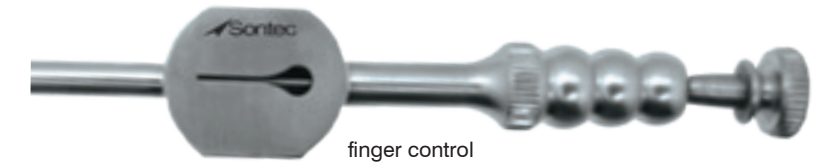

finger control

Tapered tube shaft / teardrop finger control / 8" (20.5 cm)

- 180-373 3 fr
- 180-374 4 fr
- 180-375 5 fr
- 180-376 6 fr
- 180-377 7 fr
- 180-378 8 fr
- 180-379 9 fr
- 180-380 10 fr
- 180-381 11 fr
- 180-382 12 fr

\* Also available in 6 1/2" sizes

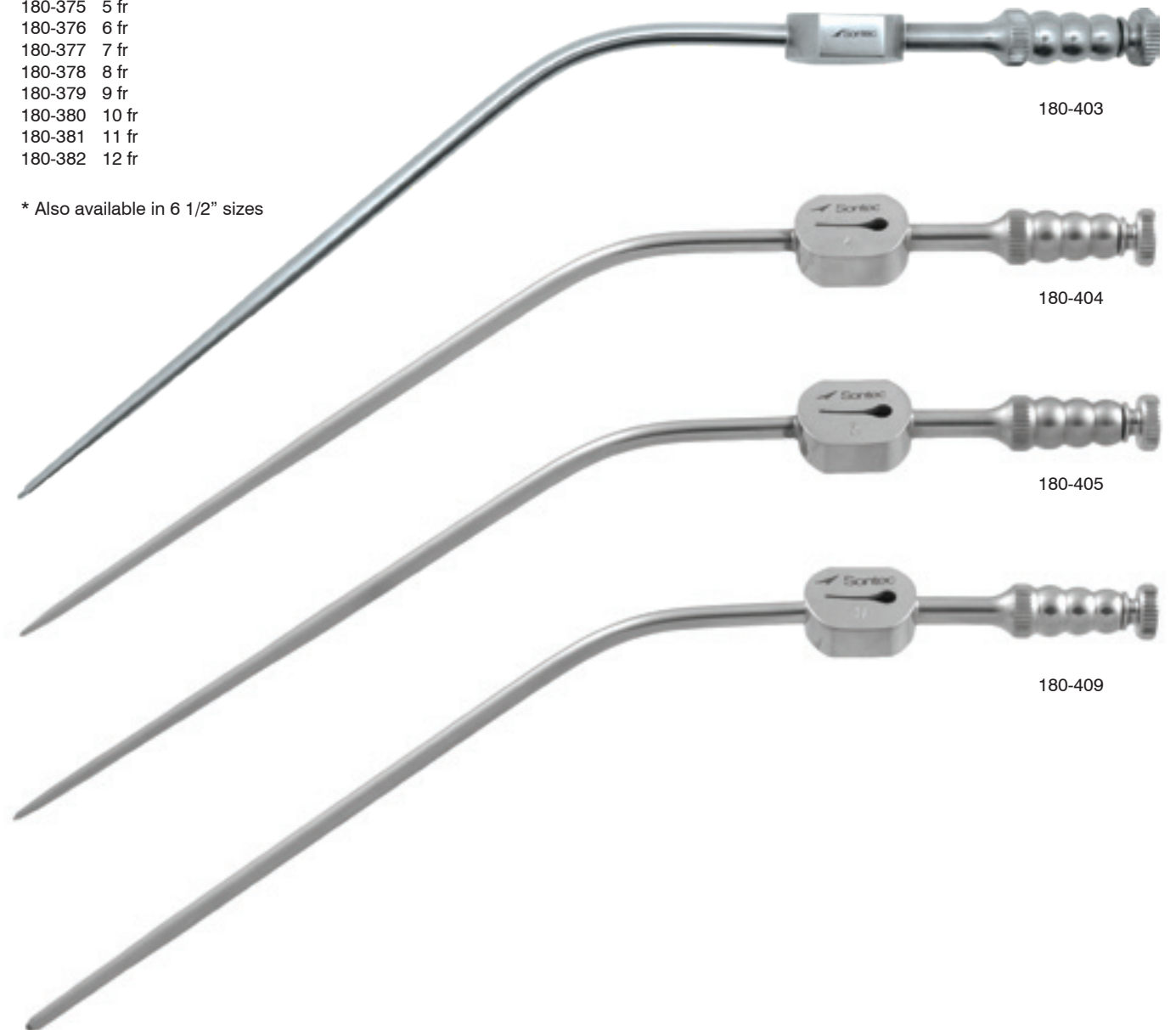

180-403

180-404

180-405

180-409

**Rhoton Micro Neuro Suction**

**Specially blunted atraumatic tips / 80 mm working length**

- 412-839 3 french
- 412-840 5 french
- 412-844 7 french
- 412-841 10 french



**100 mm working length**

- 412-845 3 french
- 412-848 5 french
- 412-846 7 french
- 412-847 10 french

**130 mm working length**

- 412-849 5 french
- 412-850 7 french
- 412-851 10 french
- 412-852 12 french

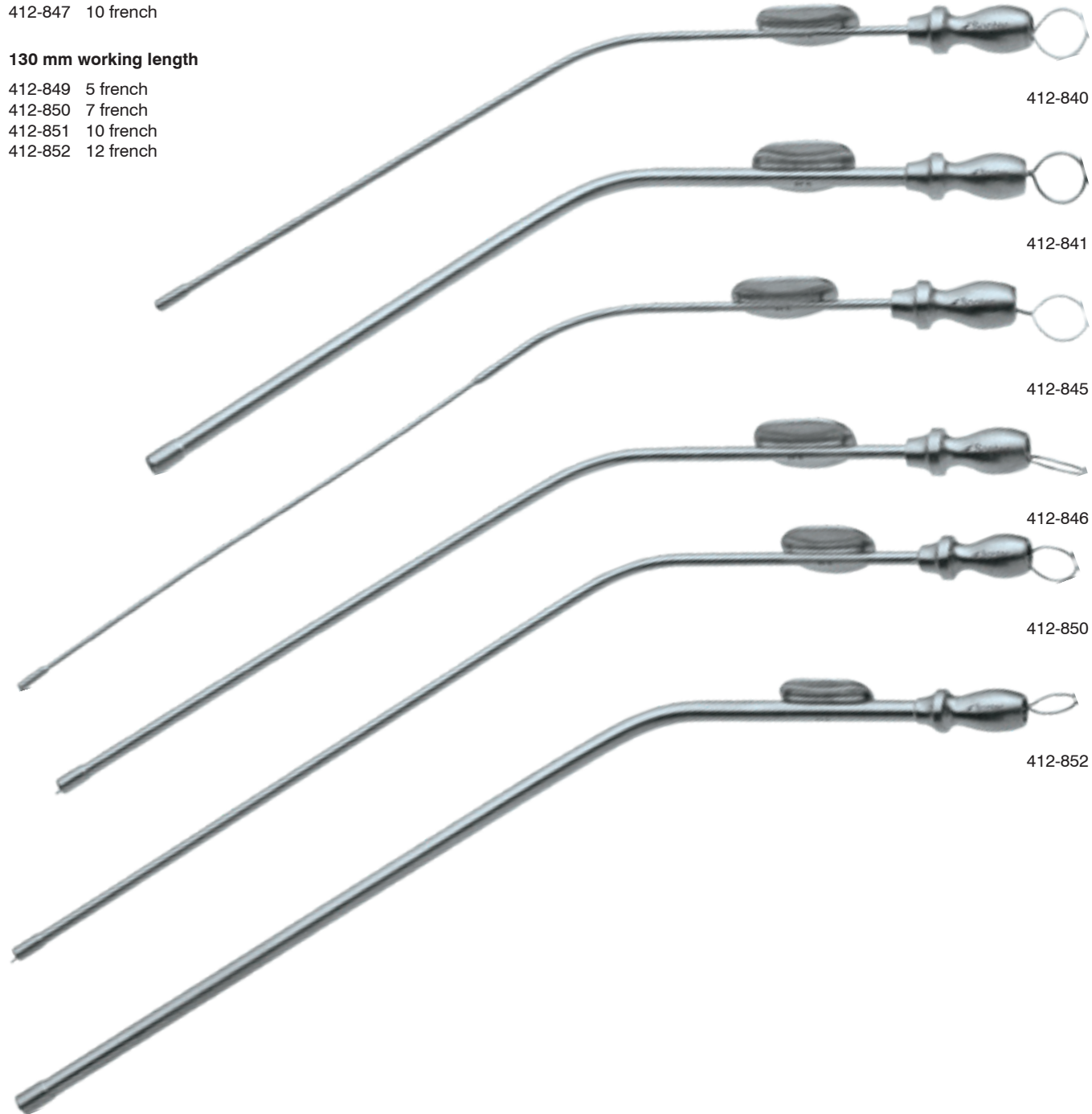

**Sontec Neuro Suction**

**tapered tubing for increased flow / short shaft / 3 hole finger control / 2 3/4" (7 cm)**

- 412-853 1.2mm tip
- 412-854 2mm tip
- 412-855 2.5mm tip

**Medium shaft / 3 hole finger control / 4" (10 cm)**

- 412-856 1.2mm tip
- 412-857 2mm tip
- 412-858 2.5mm tip

**Long shaft / 3 hole finger control / 5 1/2" (14 cm)**

- 412-859 1.2mm tip
- 412-860 2mm tip
- 412-861 2.5mm tip

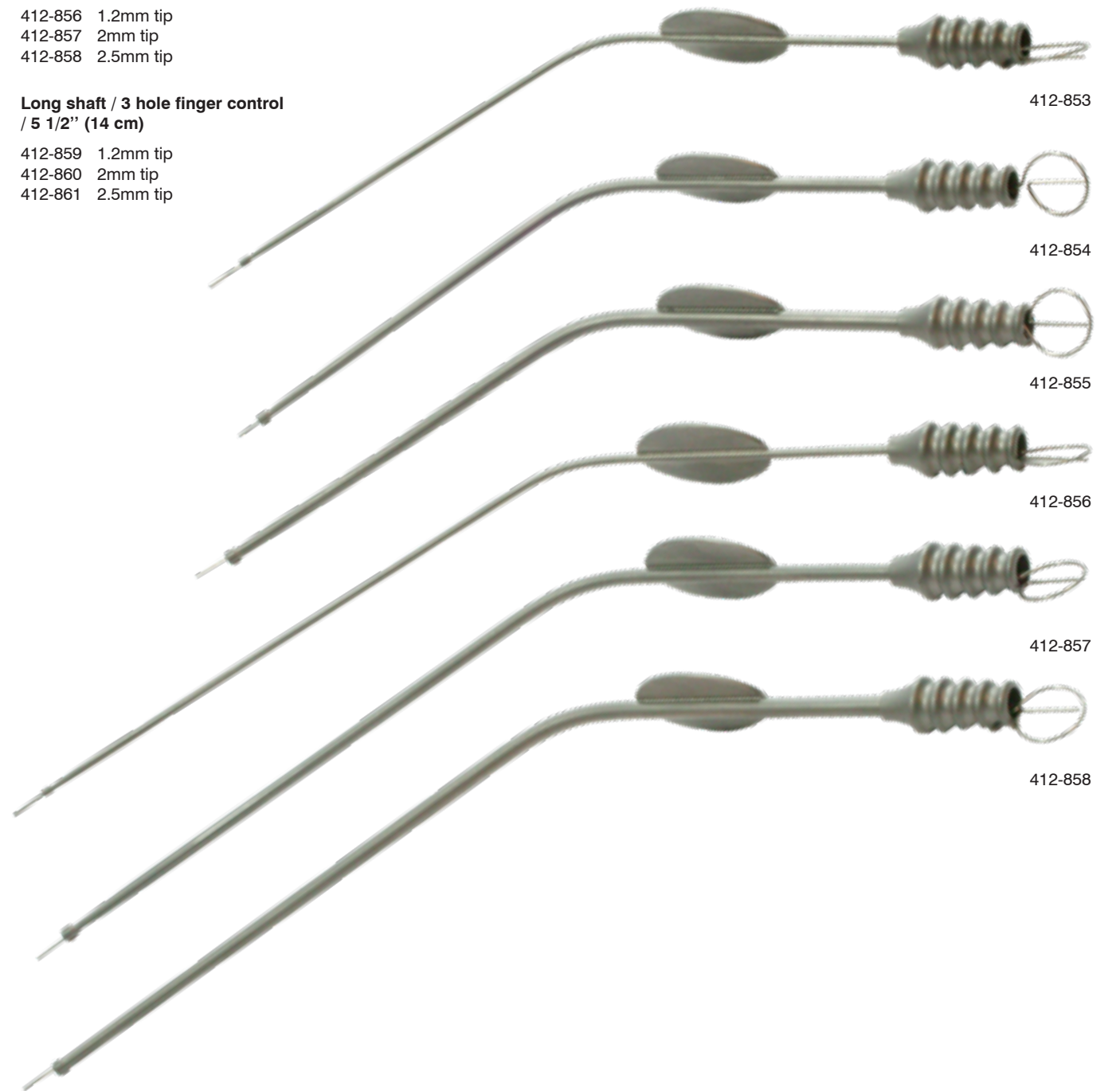

**Barnes Mini Suction Tube**

- 412-7081 1.5 mm tip
- 412-7082 1.7 mm tip
- 412-7083 2 mm tip
- 412-7084 3 mm tip



**Pashley-Frazier Suction**

Curved tip / 7" (18 cm)

- 1463-501 7 french curved right
- 1463-500 7 french curved left
- 1463-503 8 french curved right
- 1463-504 8 french curved left
- 1463-506 9 french curved right
- 1463-507 9 french curved left



**Modified Ferguson-Frazier Suction**

**Fenestrated oval tip**

- 412-685F 11 french angled
- 412-686H 12 french angled with hook lip

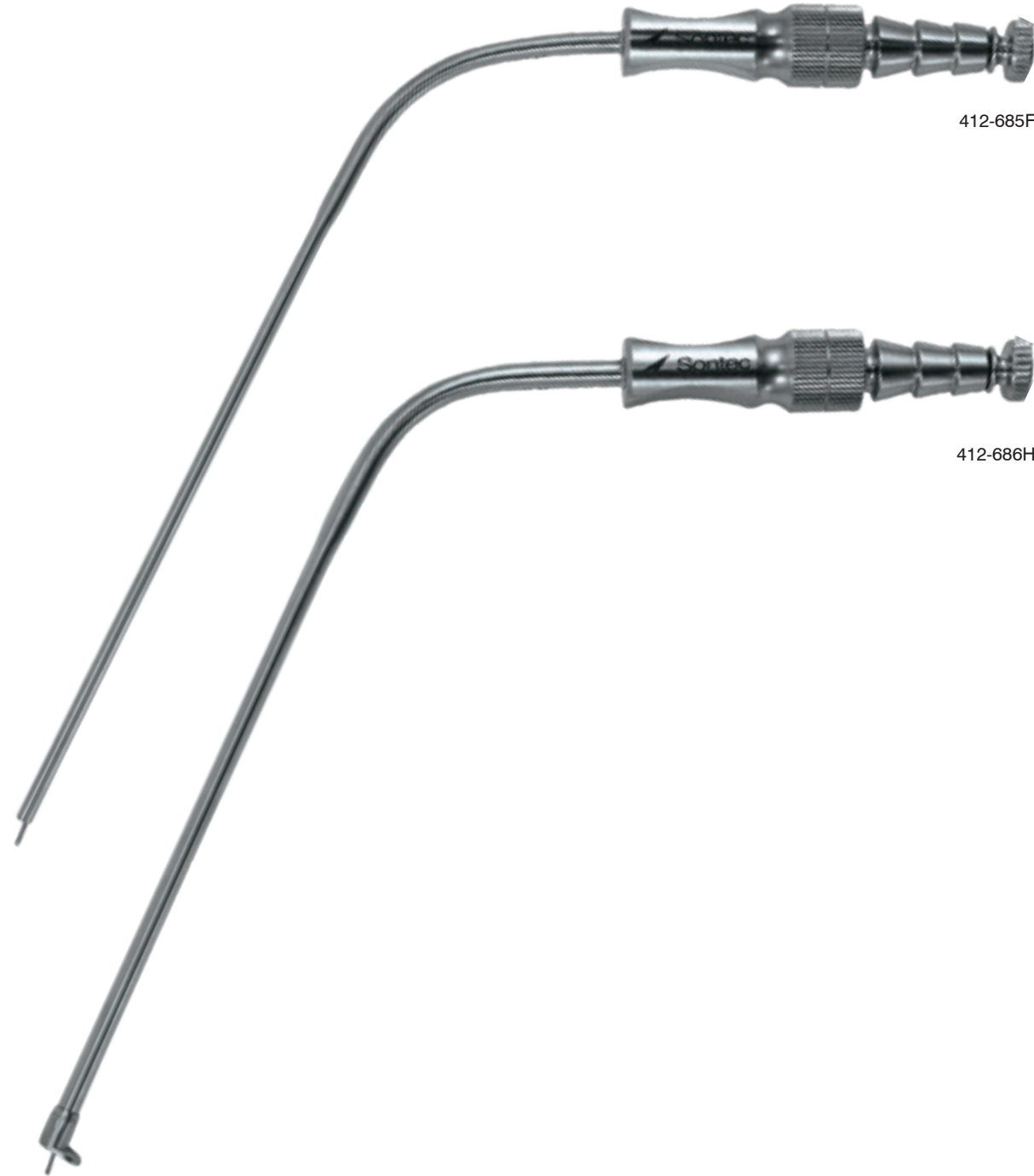

412-685F

412-686H

**Bayonet Suction Tube**

**Top finger control / 3 3/8" working length**

- 412-900 5 french
- 412-902 7 french
- 412-904 9 french

**Right finger control / 3 3/8" working length**

- 412-906 5 french
- 412-908 7 french
- 412-910 9 french



412-900

412-902

412-904

412-906

412-908

412-910

**Schmid Suction Tips**

6" (15 cm)

- 412-736-1
- 412-736-2
- 412-736-3
- 412-736-4

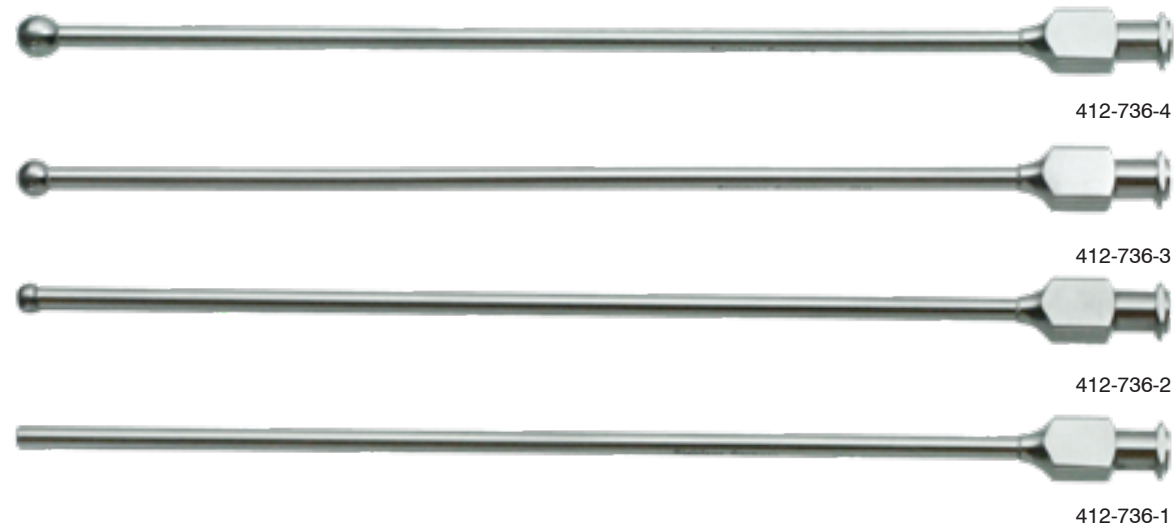

**Suction Irrigation Tube**

5 mm / with stylet / 8" (20 cm)

- 412-830 4 french x 8 french



**House Irrigator/Suction**

With thumb plate and cutoff (bypass hole) / 70mm working length / 4 1/2" (11.5 cm)

- 412-715A 2.5 french x 4 french
- 412-715C 4 french x 5 french

85mm working length / 5" (13 cm)

- 412-715 2 french x 2.5 french

95mm working length / 5 1/2" (14cm)

- 412-715B 2.5 french x 4 french
- 412-7151B 3 french x 4 french
- 412-715D 4 french x 5 french
- 412-716 5 french x 7 french
- 412-716A 6 french x 8 french
- 412-717 7 french x 10 french
- 412-718 8 french x 12 french
- 412-719 12 french x 14 french



**House-Baron Suction**

With multi port / 5" (12.5 cm)

- 412-728 5 french
- 412-728B 7 french

7" (18 cm)

- 412-729 5 french
- 412-729B 7 french

11" (28 cm)

- 412-727A 5 french
- 412-727B 7 french





**Andrews Pynchon Suction**

**Stainless / 9 1/2" (24 cm)**

- 180-432 3.0 mm
- 180-433 4.2 mm
- 180-436 5.0 mm standard

**Chrome handle / standard 5 mm / 9 1/2" (24 cm)**

180-439



180-433

**Anthony Suction**

**4 mm tip / 10" (25.5 cm)**

180-440



180-440

**Braun-Ralph Suction**

**5mm suction tube / 70° angle with 7 mm Ø 40 mm long fluted tip / 10" (25.5 cm)**

2700-309



2700-309

**Yankauer Suction**

**Chrome / 11 3/4" (30 cm)**

180-447



180-447

**Stainless Steel / 11 3/4" (30 cm)**

180-448



180-448

**With universal fiber optic light guide / stainless steel / 11 1/4" (28.5 cm)**

180-449 2mm



180-449

**Buie Suction Tube**

**With finger valve / 16" (40.5 cm)**

508-523 15 french



508-523

**Ross Sump Suckers**

**Swivel head**

- 2700-390 adult 3/16" tube
- 2700-392 child 3/16" tube
- 2700-394 infant 1/8" tube



2700-390



2700-392



2700-394

**Baby Poole Suction**

**Curved / 17 french / 8" (20.3 cm)**

180-420



180-420

**Poole Suction**

**8 3/4" (22 cm)**

- 180-424 cvd 23 french
- 180-422 str 30 french



180-422



**Adson Suction**

**Curved tip**

- 412-720 12 french 5" (12.5 cm)
- 412-724 12 french 8" (20 cm)



412-720

**Killian (Von Eicken) Suction**

**Curved / 6" (15 cm)**

- 412-815 4 mm end short curve
- 412-810 4 mm end full long curve
- 412-805 3 mm end short curve
- 412-800 3 mm end long curve

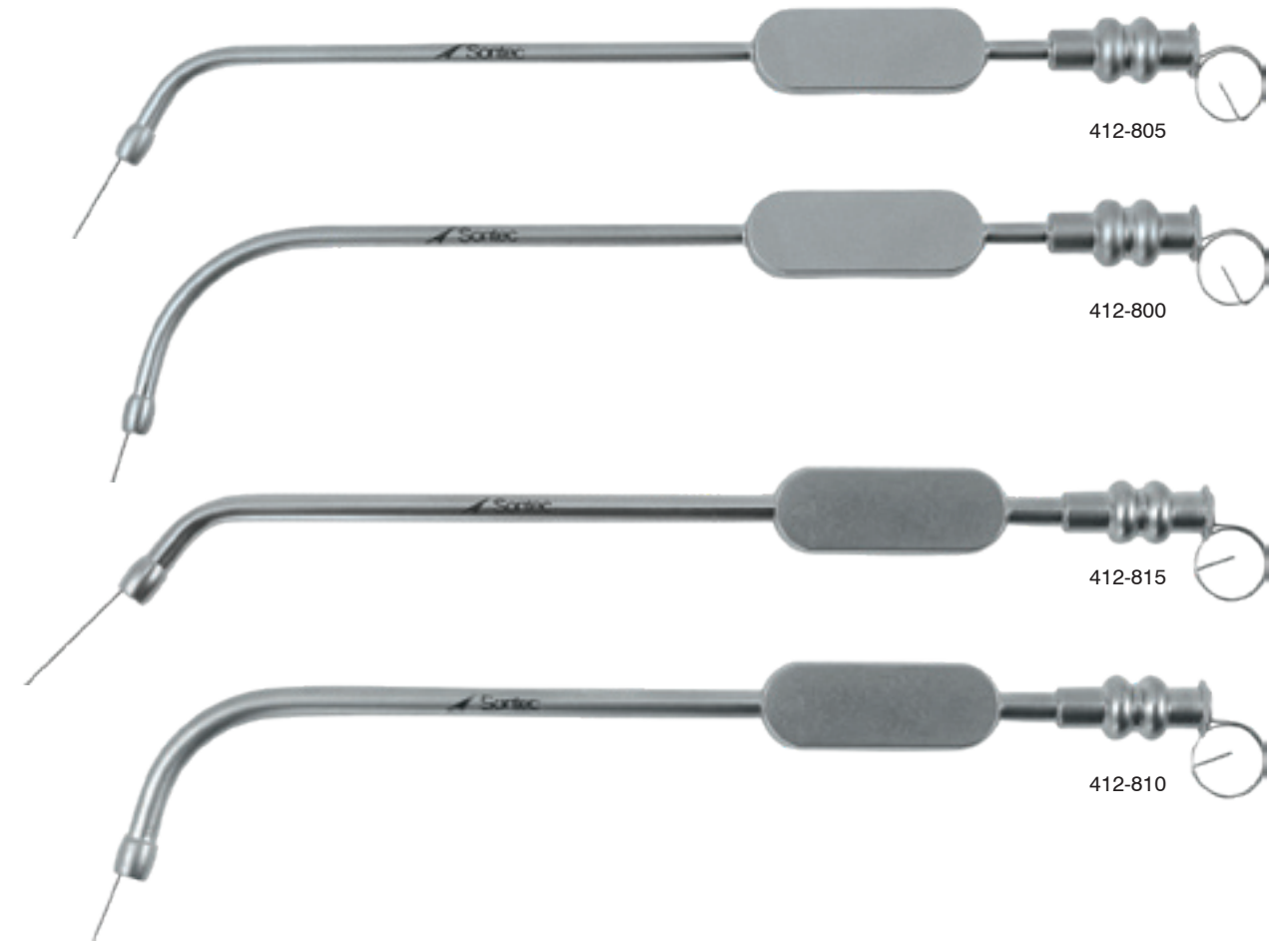

412-805

412-800

412-815

412-810

**Sontec Perfusion Cannula Suction**

**For pediatric Use**

- 412-740 style #1
- 412-741 style #2

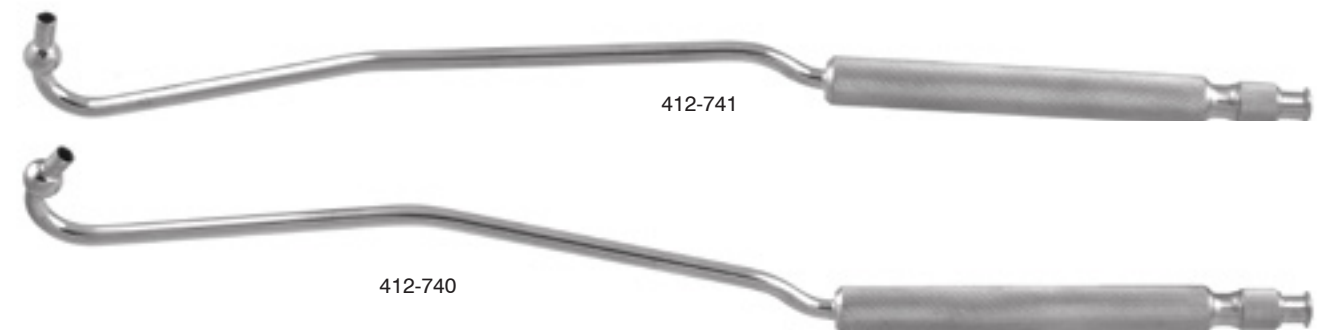

412-741

412-740

**Coupland Suction Set**

6 1/2" (16.5 cm)

412-672-SET

set includes:

- 412-673 tip #1 1.5 mm wide
- 412-674 tip #2 2.0 mm wide
- 412-675 tip #3 2.5 mm wide
- 412-676 tip #4 3.5 mm wide
- 412-672H handle



handle only

412-672H

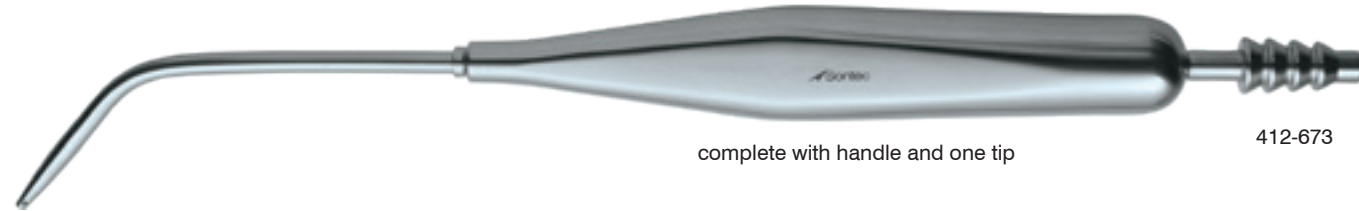

complete with handle and one tip

412-673



412-676



412-675



412-674



412-673

**Pashley Pipe Suction Tube Holding Device**

1463-461



1463-461



 Sontec Instruments®

ENT SAWS

**Joseph Bone Saw**

Single-sided / 7 1/2" (19 cm)

1100-466



1100-466

**Joseph Bayonet Bone Saw**

Single-ended / single-sided / 8" (20.5 cm)

345-255 right

345-256 left

345-257 set: including one right & one left



345-255



345-256

**Langenbeck Metacarpal Saw**

Blade length 4 1/4" (10 cm) / 9 1/4" (23.5 cm)

345-212



345-212

**Linderman Amputation Saw**

Blade length 20 cm / 8" (20.5 cm)

345-214



345-214

**Wellenschliff Nasal Saw**

Straight / 7 1/2" (19 cm)

345-248

345-249 round end



345-248



345-249



 Sontec Instruments®

Eye OCULAR PLASTIC

**Corneal Eye Shield**

Sterilize by ETO only / green is the normal stock color, to order other colors please specify when minimum quantity is 4 each

1100-409PG	pediatric	15.5 mm x 16.5 mm
1100-409SG	small	20.5 mm x 22.5 mm
1100-409MG	medium	24.5 mm x 22.5 mm
1100-409LG	large	24.5 mm x 26.5 mm

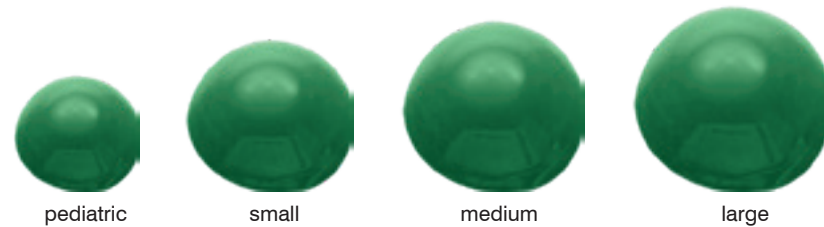

\* Color order key: W=White / O=Orange / C=Clear  
 \* Colors: clear, white, green, or orange  
 \* Please be specific when ordering



**Bilateral / autoclave safe / with suction cup / transparent yellow**

1100-408XSY	x-small	23.5 x 21.5 mm
1100-408SY	small	26 x 23.5 mm
1100-408MY	medium	27.5 x 24.5 mm
1100-408LY	large	28.5 x 25.5 mm



suction cup included



**Bilateral / autoclave safe / with suction cup / black**

1100-408XSB	x-small	23.5 x 21.5 mm
1100-408SB	small	26 x 23.5 mm
1100-408MB	medium	27.5 x 24.5 mm
1100-408LB	large	28.5 x 25.5 mm



suction cup included



**Bilateral / with handle / autoclave safe/ medium 27 x 24 mm**

1100-408MYH	transparent yellow
1100-408MBH	black



suction cup included



**Suction Cup Handle for Eye Shields**

18-8028	silicone blue
18-8030	latex free red



**Corneal Eye Shields in Non-Reflective Laser Finish or Electro Blue Coating**

**Non-reflective laser finish stainless / 22 mm x 27 mm**

18-8026	can be used with suction cup 18-8028
18-8025	can be used with suction cup 18-8028 pair
18-8022	with handle
18-8020	with handle pair



**Electro blue coated / 22 mm x 27 mm**

18-8026B	without handle
18-8025B	without handle pair
18-8022B	with handle
18-8020B	with handle pair



**Stainless / Cox II H with offset handle / medium 25.5 mm x 23 mm**

18-8032L	left
18-8032R	right

**Stainless / Cox II / with out handle / includes suction cup**

18-8036	extra small	22 mm x 19.5 mm
18-8037	small	24 mm x 21 mm



**Freer Periosteal Elevator**

Double-ended / round handle / curved / 3.5 mm tip / sharp / 7 1/4"

1100-798H

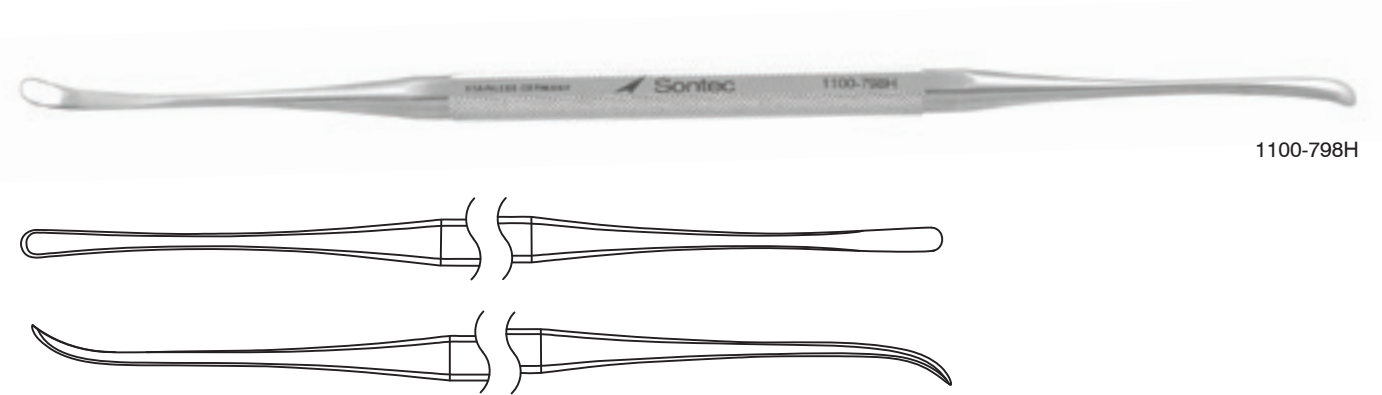

1100-798H

**Silicone Eye Implants**

Please specify size when ordering / not for medical use (vet only)

- 1100-411-10 10 mm
- 1100-411-11 11 mm
- 1100-411-12 12 mm
- 1100-411-13 13 mm
- 1100-411-14 14 mm
- 1100-411-15 15 mm
- 1100-411-16 16 mm
- 1100-411-17 17 mm
- 1100-411-18 18 mm
- 1100-411-19 19 mm
- 1100-411-20 20 mm
- 1100-411-21 21 mm
- 1100-411-22 22 mm
- 1100-411-23 23 mm
- 1100-412-24 24 mm
- 1100-412-26 26 mm
- 1100-412-28 28 mm
- 1100-412-30 30 mm
- 1100-412-33 33 mm
- 1100-412-36 36 mm
- 1100-412-38 38 mm
- 1100-412-40 40 mm
- 1100-412-43 43 mm
- 1100-412-45 45 mm
- 1100-412-47 47 mm

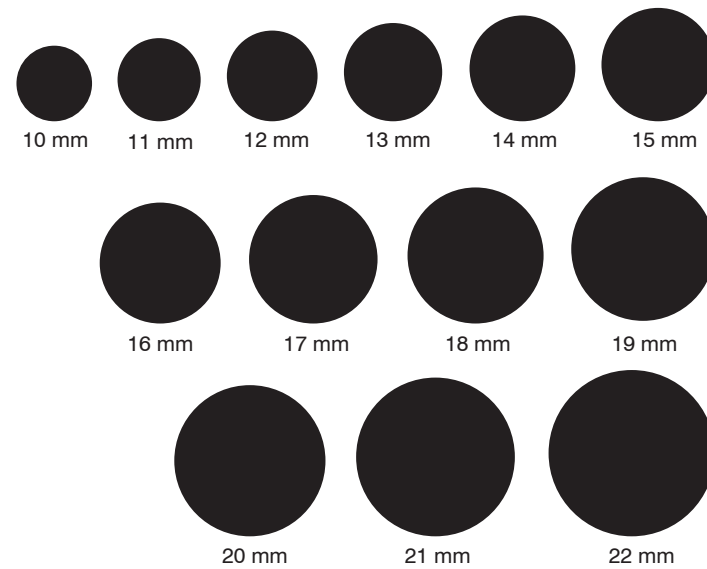

**Carter Sphere Introducer**

5" (12.5 cm)

17-1000

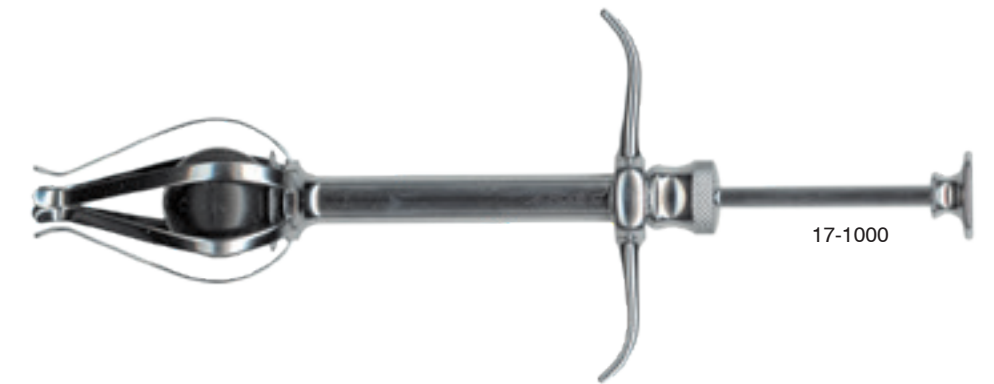

17-1000

**Bishop-Harmon Irrigation Bulb Cannula Set**

Adapter and blue silicone bulb / angled cannula

- 16-5300-SET complete (bulb, adapter, 19 gauge cannula, cannula set)
- 16-5310 silicone bulb
- 16-5320 adapter
- 16-5330 19 gauge cannula
- 16-5331 21 gauge cannula (separate purchase)
- 16-5340 bulb & adapter (separate purchase)
- 16-5325 plastic adapter (bag of 5 each)
- 16-5321 plastic adapter (1 each)



16-5300-SET



16-5330

16-5320

16-5325



**Lacrimal Cannula**

Reinforced shaft / 23 gauge

16-3300 straight  
16-3310 curved



16-3310

Straight / 23 gauge / 25 mm length

16-3290

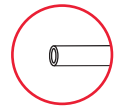

16-3290

**Severin Lacrimal Cannula**

Curved

1103-500 19 gauge  
1103-500A 20 gauge  
1103-500B 21 gauge  
1103-500C 22 gauge  
1103-500D 23 gauge  
1103-500E 24 gauge  
1103-500F 25 gauge  
1103-500G 26 gauge  
1103-500H 27 gauge  
1103-500J 30 gauge

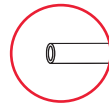

1103-500A

**Fasanella Lacrimal Cannula**

Curved / 15 mm length / 23 gauge

16-3350



16-3350

**Lacrimal Cannula**

Side opening / straight / 28 mm length / 19 gauge

16-3346

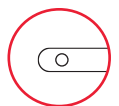

16-3346

**Shahinian Lacrimal Cannula**

Smooth conical tip / straight / 0.3 mm side opening / 11 mm length / 23 gauge

16-3314

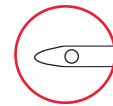

16-3314

**McIntyre Lacrimal Cannula**

0.3 mm dual sideports / 23 gauge

16-3320 straight  
16-3330 curved

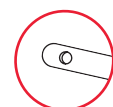

16-3330

**West Cannula**

Side opening / curved / 25 mm length / 23 gauge

16-3348

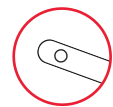

16-3348

**Air Injection Cannula**

Angled / 5 mm tip

16-3810 25 gauge  
16-3820 27 gauge  
16-3800 30 gauge



16-3820

Angled / 7 mm tip

16-3821 27 gauge  
16-3826 30 gauge



16-3821

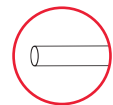
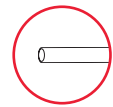

**Sewall Orbital Retractor**

Double ended / 7mm curved / 3.5mm curved

10-3890



10-3890

**Jaeger Lid Plate**

Autoclave safe / concave model with medium and large end

10-4501 transparent yellow



10-4501

Autoclave safe / concave model with small and medium end

10-4504 black



10-4504

Stainless

10-4520 1/2 laser finish  
10-4522 1/2 laser finish slight "S" curved  
10-4525 blue electro coat  
10-4530 stainless steel  
10-4535 black laser finish



10-4520



10-4522



10-4525

**Flieringa Scleral Fixation Ring**

Set of 8 sizes, 15 mm-22 mm

10-3100

Also sold individually

- 10-3140 14 mm
- 10-3150 15 mm
- 10-3160 16 mm
- 10-3170 17 mm
- 10-3180 18 mm
- 10-3190 19 mm
- 10-3200 20 mm
- 10-3210 21 mm
- 10-3220 22 mm



10-3100

**McNeill-Goldman Scleral Fixation Ring & Blepharostat**

Stainless

- 10-3310 small 15 mm inside diameter
- 10-3312 medium 16 mm inside diameter
- 10-3314 large 17 mm inside diameter



10-3314

**Schepens Scleral Depressor**

With thimble / black

- 10-3800 small #8
- 10-3810 medium #10
- 10-3820 large #12



10-3800

10-3820

**Scleral Depressor**

Double-ended / with clip

- 10-3825
- T10-3825 titanium
- T10-3840 titanium handle



10-3825



T10-3825



T10-3840

**Desmarres Lid Retractor**

Stainless steel / 5 1/2" (14 cm)

- 10-4192 6 mm
- 10-4194 8 mm
- 10-4196 9 mm
- 10-4198 10 mm
- 10-4200 11 mm
- 10-4201 11 mm electro-blue coated
- 10-4206 12 mm
- 10-4207 12 mm electro-blue coated
- 10-4210 13 mm
- 10-4213 13 mm electro-blue coated
- 10-4216 14 mm
- 10-4220 15 mm



10-4200



10-4223

- 10-4223 15 mm electro-blue coated
- 10-4226 16 mm
- 10-4227 16 mm electro-blue coated
- 10-4230 17 mm



10-4236

- 10-4233 17 mm electro-blue coated
- 10-4236 18 mm
- 10-4237 18 mm electro-blue coated
- 10-4240 19 mm

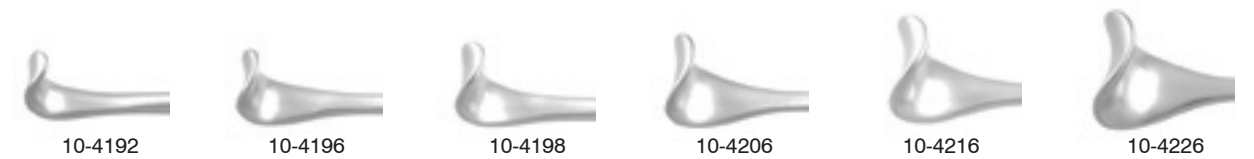

10-4192

10-4196

10-4198

10-4206

10-4216

10-4226

**Gil-Vernet Desmarres Retractor**

5 3/4" (14.5 cm)

- 10-4211 size 1
- 10-4221 size 2
- 10-4231 size 3
- 10-4241 size 4



10-4211

10-4231



10-4221

10-4241



10-4241

**Eye Ribbone Retractor**

Malleable / 4 1/4" (11 cm)  
10-5400 stainless



10-5400

**Flexible Neck Hook Retractor**

5" (13 cm)  
205-819 sharp 3 prongs

6" (15 cm)  
205-820 sharp 1 prong  
205-826 blunt 1 prong  
205-822 sharp 2 prongs  
205-828 blunt 2 prongs  
205-824 sharp 3 prongs  
205-830 blunt 3 prongs

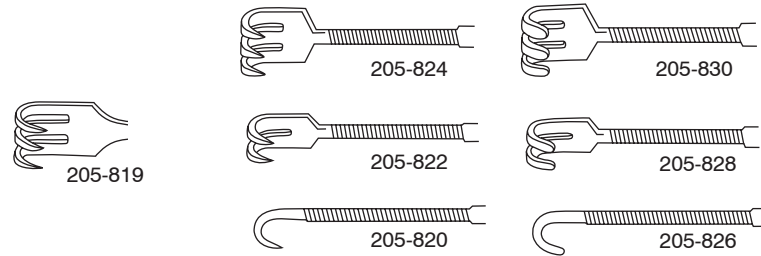

205-822

205-828

**Blair Hook Retractor**

Four prongs / 5" (12.5 cm)  
205-847 sharp  
205-848 blunt



205-848

**Knapp Rollet Hook Retractor**

4 prongs / 5" (12.5 cm)  
205-844 sharp  
205-846 blunt



205-844

**Miller Skin Rake Retractor**

5" (12.5 cm)  
199-480 9 prong sharp  
199-481 9 prong blunt  
199-482 6 prong sharp  
199-483 6 prong blunt



199-481

**Paul Skin Rake Retractor**

Blunt / 5" (12.5 cm)  
199-490



199-490

**Helveston Tissue Retractor**

2 mm wide / curved blade  
10-5480 stainless  
T10-5480 titanium



T10-5480

**Helveston Tissue Retractor**

Single ended / curved / flat handle / 5"  
10-5487 7 mm  
10-5489 9 mm  
10-5491 11 mm

Single ended / curved / flat handle / titanium / 5"  
T10-5487 4 x 7 mm  
T10-5489 4 x 9 mm  
T10-5491 4 x 11 mm



10-5487

10-5489

10-5491

T10-5487

T10-5489

T10-5491

**Algerbrush II Corneal Rust Ring Remover Burr**

**Battery powered**

- 11-4600 complete w/ 0.5 mm burr
- 11-4601 complete w/ 1 mm burr
- 11-4610 burr only 0.5 mm
- 11-4609 burr only 1 mm



11-4600

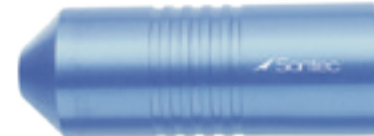

11-4610

**Algerbrush II Pterygium Burr**

**Battery powered**

- 11-4611 complete w/ 2.5mm Fine ball tip
- 11-4612 2.5 mm fine ball tip only
- 11-4613 complete w/ 3.5mm medium ball tip
- 11-4614 3.5 mm medium ball tip only
- 11-4615 complete w/ 4mm fine wheel
- 11-4616 4 mm fine wheel tip only
- 11-4617 complete w/ 5mm medium wheel
- 11-4618 5 mm wheel tip only



11-4611



11-4612



11-4614



11-4616



11-4618

**Meyerhoefer-Chalazion Curette**

**5" (12.5 cm)**

- 12-1285 0.5 mm
- 12-1290 1.0 mm
- 12-1300 1.5 mm
- 12-1310 1.75 mm
- 12-1320 2.0 mm
- 12-1355 2.5 mm
- 12-1360 3.0 mm
- 12-1365 3.5 mm
- 12-1367 4.0 mm
- 12-1368 4.5 mm

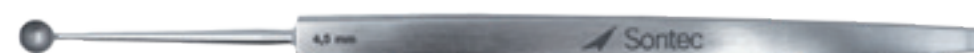
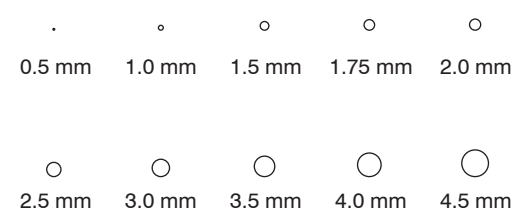

12-1368

**House Curette**

**Double-ended / 5 3/4" (14.5 cm)**

- 199-133 both ends cvd 1.5 mm x 1.2 mm micro tip



199-133

**Double-ended / 6" (15 cm)**

- 199-132 one end angled, one end str
- 199-129 both ends angled
- 199-131 both ends str



199-129



199-131



199-132

**Double-ended / 7" (18 cm)**

- 199-130 both ends angled



199-130

**Double-ended / 9" (22.8 cm)**

- 199-136 both ends straight



199-136

**Davis Brain Spatula**

Malleable / 7" (18 cm)

- 412-770 1/4"
- 412-771 3/8"
- 412-772 1/2"
- 412-773 5/8"
- 412-774 3/4"
- 412-775 1"
- 412-776 1 1/4"
- 412-777 1 1/2"



412-770



412-771



412-772



412-773



412-774



412-775

**Davis Brain Black Silicon Spatula**

Silicone coated / malleable / 7" (18 cm)

- 412-766 small 6 mm & 10 mm
- 412-767 medium 9 mm & 15 mm
- 412-768 large 11 mm & 20 mm
- 412-769 x-large 14 mm & 25 mm



412-766



412-767



412-768



412-769

**Kerrison Punch (Ocular-plasti) 90° Rongeur**

4" (10 cm) shaft



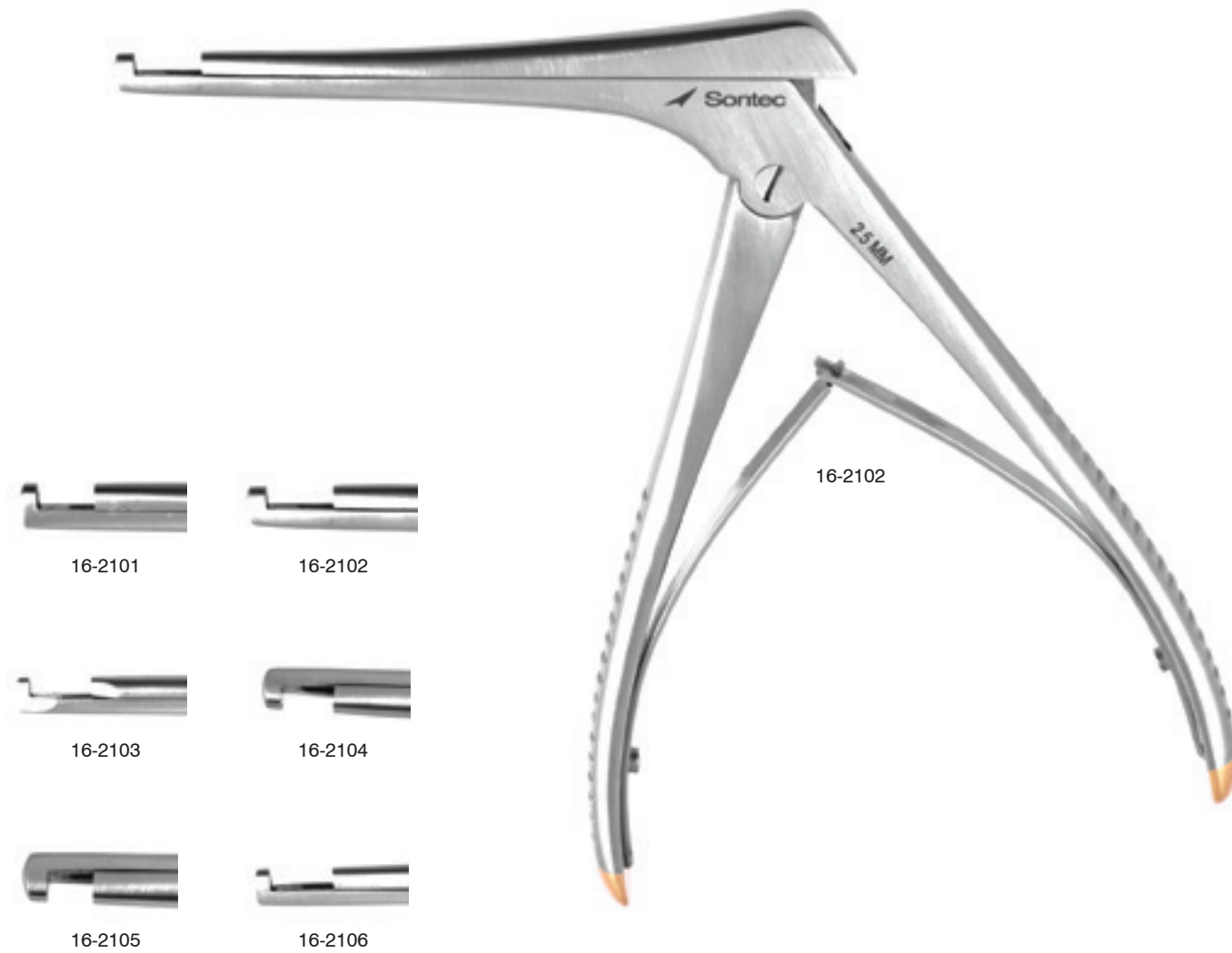

- 16-2100 1.0 mm wide up
- 16-2101 1.5 mm wide up
- 16-2102 2.0 mm wide up
- 16-2106 2.5 mm wide up
- 16-2103 3.0 mm wide up
- 16-2104 3.0 mm wide down
- 16-2105 4.0 mm wide down



**Kerrison Punch (Ocular-plasti) 40° Rongeur**

4" (10 cm) shaft

- 16-2096 1.0 mm wide
- 16-2097 1.5 mm wide
- 16-2098 2.0 mm wide
- 16-2099 3.0 mm wide

		Bite Width	
40° Up-Angle		1 mm	16-2096
		1.5 mm	16-2097
		2 mm	16-2098
		3 mm	16-2099

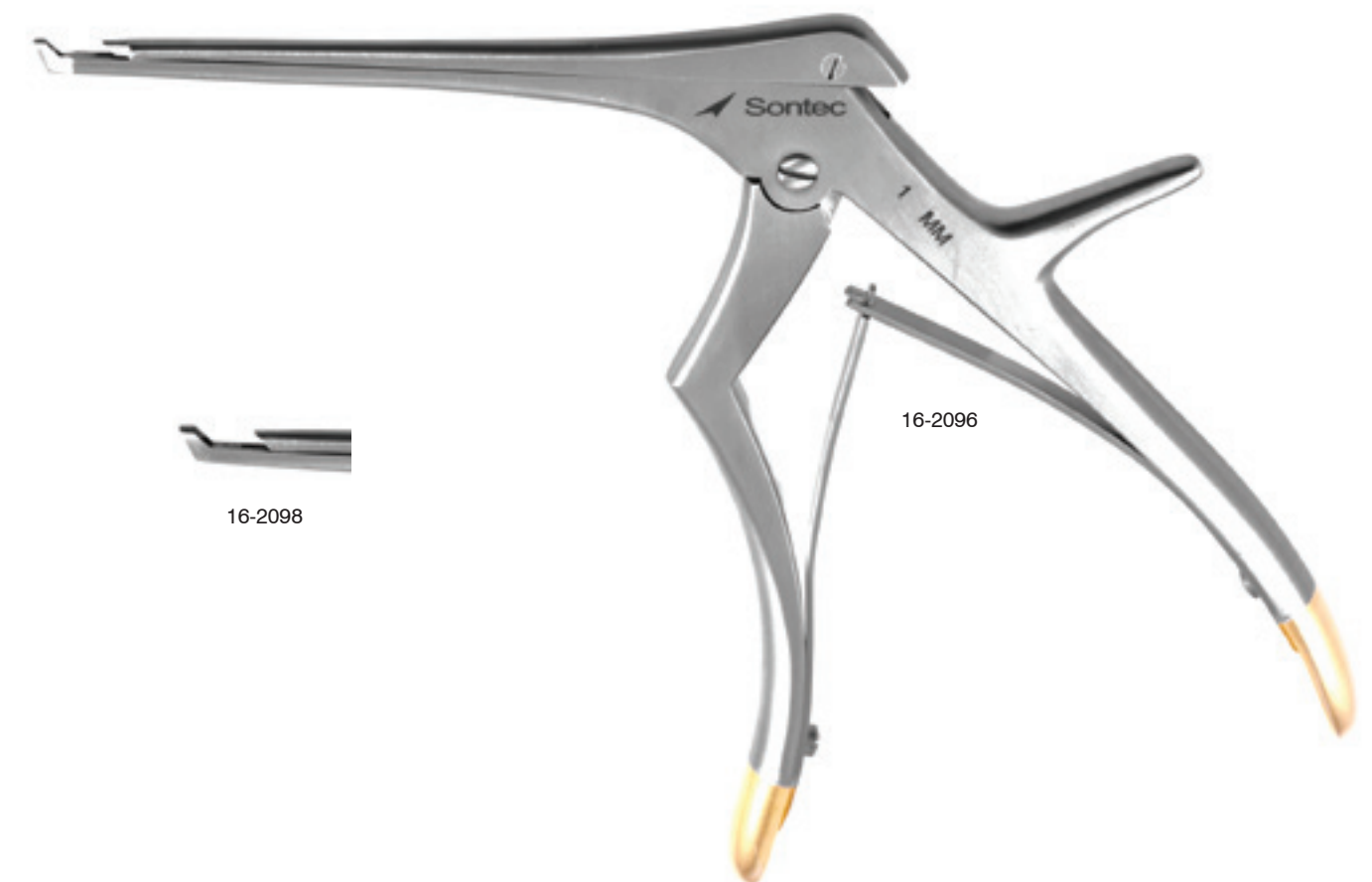

**Barraquer Wire Speculum**

**Standard**

- 10-1000 10 mm blades
- T10-1000 10 mm blades titanium
- 10-1005 12 mm blades
- T10-1005 12 mm blades titanium
- 10-1010 15 mm blades
- T10-1010 15 mm blades titanium
- 10-1015 right third eye lid
- 10-1016 left third eye lid

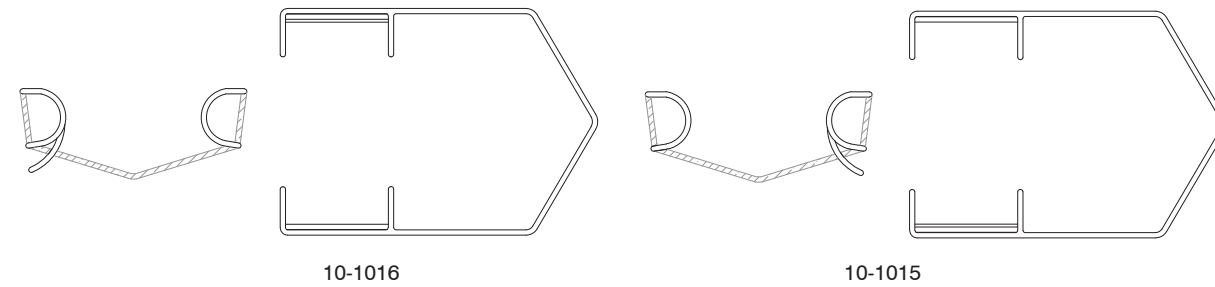
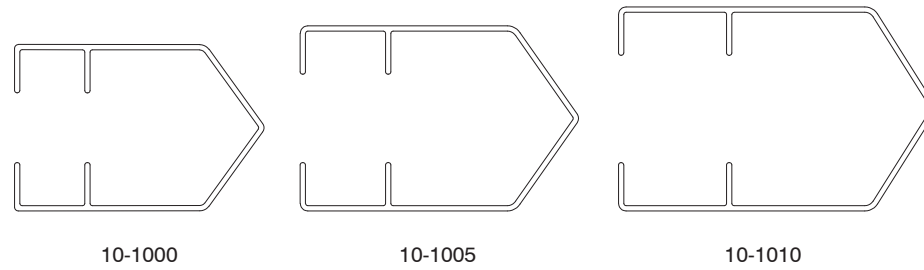

**Closed wire / curved blades**

- 10-1000C small
- T10-1000C small titanium
- 10-1010C large
- T10-1010C large titanium

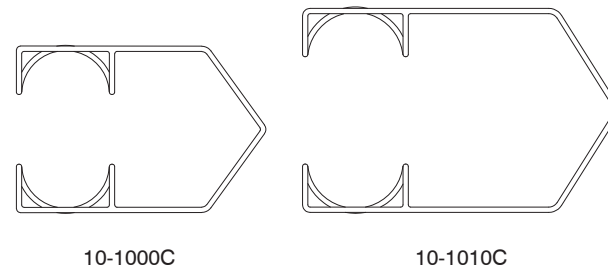

**Solid blades**

- 10-1020 small stainless
- T10-1020 small titanium
- 10-1030 large stainless
- T10-1030 large titanium

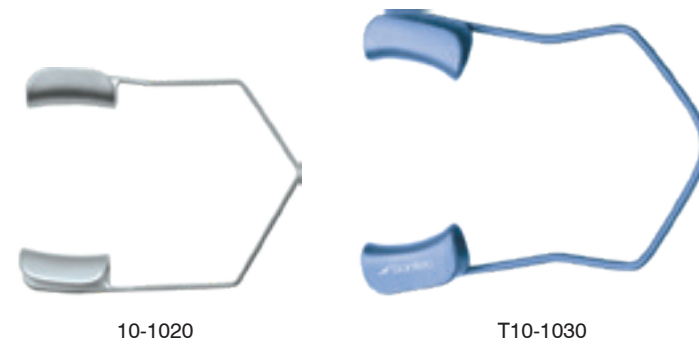

**Kratz-Barraquer Wire Speculum**

**Open blades / stainless steel**

- 10-1054 4 mm blades
- 10-1053 8 mm blades
- 10-1055 10 mm blades
- 10-1050 15 mm blades

**Open blades / titanium**

- T10-1054 4 mm blades
- T10-1053 8 mm blades
- T10-1056 10 mm blades
- T10-1051 15 mm blades

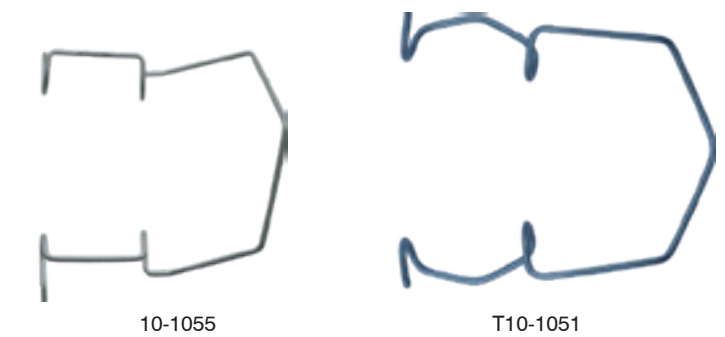

**Kratz Aspirating Wire Speculum**

**V-shaped blades**

- 10-1043 open blades
- 10-1062 closed blades

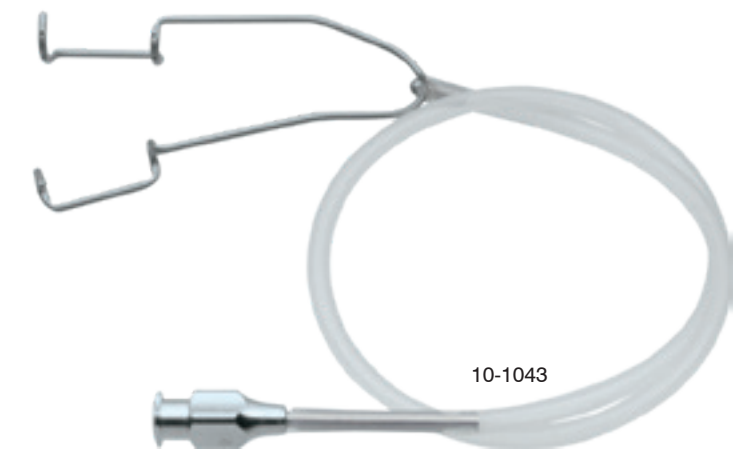

**McKee Eye Speculum**

Malleable  
10-1150



10-1150

**Barraquer Infant Wire Speculum**

Closed wire blades / gently curved springs / v-shaped

10-1340 4 mm blades

Closed wire blades

10-1350 4 mm blades 30 mm total length

10-1360 8 mm blades

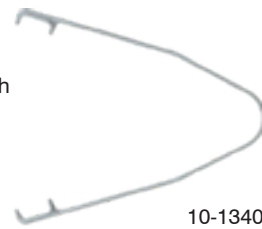

10-1340



10-1350

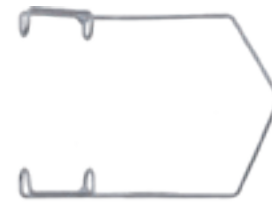

10-1360

**Sauer Lid Speculum**

Solid blades

10-1300 for infants

10-1300S for premature infants

T10-1320 adult



10-1300S



10-1300



T10-1320

**Murdoch Eye Speculum**

Locking screw / open blades

10-1420 small

10-1422 large



10-1422

**Cook Eye Speculum**

Non-magnetic / locking screw / Solid blades

10-1400 very small

10-1401 small

10-1402 medium

10-1403 large

Non-magnetic / locking screw / Double bar

10-1404 small 11 mm

10-1405 large 15 mm



10-1404



10-1405



10-1400



10-1401

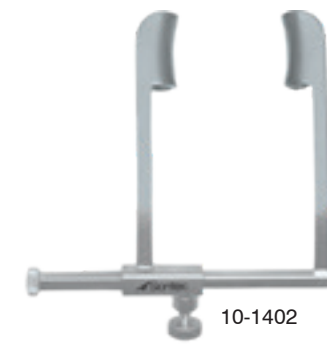

10-1402



10-1403



**Bowman Lacrimal Probe**

**Sterling silver / butterfly handle**

- 16-2520 set of six probes
- 16-2530 size 0000/000
- 16-2540 size 00/0
- 16-2541 size 0/1
- 16-2550 size 1/2
- 16-2551 size 2/3
- 16-2560 size 3/4
- 16-2561 size 4/5
- 16-2570 size 5/6
- 16-2571 size 6/7
- 16-2580 size 7/8

**Stainless steel / butterfly handle**

- 16-2530S size 0000/000
- 16-2540S size 00/0
- 16-2550S size 1/2
- 16-2560S size 3/4
- 16-2570S size 5/6



16-2580

16-2570

16-2560

16-2550

16-2540

16-2530

**Bowman Lacrimal Probe**

**Stainless steel / round handle**

- 16-2578 set of six probes
- 16-2579 size 0000/000
- 16-2581 size 00/0
- 16-2582 size 0/1
- 16-2583 size 1/2
- 16-2584 size 2/3
- 16-2585 size 3/4
- 16-2586 size 4/5
- 16-2587 size 5/6
- 16-2588 size 6/7
- 16-2589 size 7/8



16-2579

16-2581

16-2583

16-2585

16-2587

16-2589

**Catalano Lacrimal Intubation Set**

Includes 2 blunt 0.7 mm diameter probes attached to 30.5 cm long silicone tubing

16-2590



16-2590

**Jackson Lacrimal Intubation Set**

Includes 2 blunt 0.9 mm diameter probes attached to 30.5 cm long silicone tubing

16-2592



16-2592

**Crawford Lacrimal Intubation Set**

Includes 2 olive tip 0.6 mm diameter probes attached to 30.5 cm long silicone tubing

16-2594



16-2594

**Bodian Lacrimal Probe Set**

Includes 2 curved blunt 1.0 mm diameter probes attached to 30.5 cm long silicone tubing

16-2596

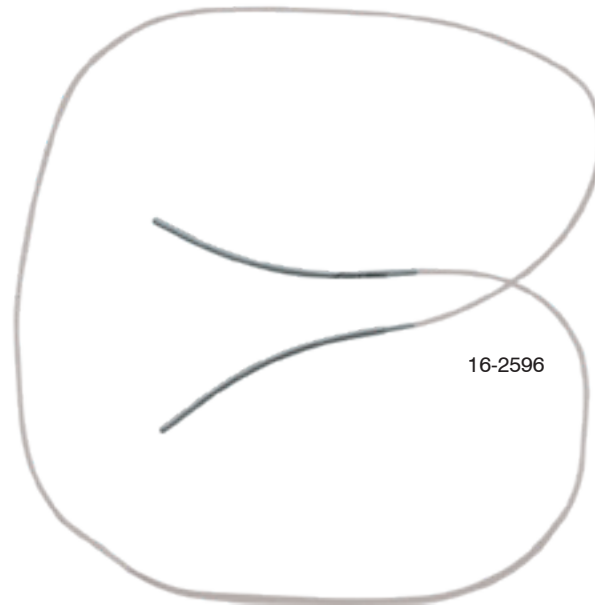

**Pigtail Lacrimal Probe Dilator**

15 mm tip w/holes

16-2600



16-2600

**Castroviejo Lacrimal Dilator**

Double-ended

16-2510



16-2510

**Infant Lacrimal Dilator**

Single-ended

16-2440



16-2440

**Wilder Lacrimal Dilator**

Single-ended

16-2460 fine, #1

16-2470 medium, #2

16-2480 heavy, #3



16-2460



16-2470



16-2480

**Muldoon Lacrimal Dilator**

Single-ended / graduated blunt tip

16-2500



16-2500

**Lockhart Mummery Fistula Probe**

With eye hole at tip / 6 1/2" (16.5 cm)

- 15-0230 #1 straight
- 15-0231 #2 45° curve
- 15-0232 #3 90° curve
- 15-0233 #4 hook



15-0230

15-0231

15-0232

15-0233

**Grooved Director Tongue Tie**

- 197-690 4 1/2" (11.5 cm)
- 197-691 5" (12.5 cm)
- 197-692 5 1/2" (14 cm)
- 197-693 6" (15 cm)
- 197-694 7" (17.8 cm)
- 197-695 8" (20 cm)

With probe point

- 197-700 4 1/2" (11.5 cm)
- 197-701 5" (12.5 cm)
- 197-702 5 1/2" (14 cm)
- 197-703 6" (15 cm)
- 197-704 7" (17.8 cm)
- 197-705 8" (20 cm)



197-701

**Larry Fistula Probe**

Grooved director / 6" (15 cm)

508-544



508-544

**St. Marks Fistula Probe**

Curved / 7" (18 cm)

508-541



508-541

**Buie Fistula Probe**

Sterling silver shaft / 5 3/8" (13.5 cm)

508-536

508-538 heavy



508-536

**Barr Fistula Probe**

11" (28 cm)

508-542 w/ eye at tip

508-543



508-543

**Barr Double Ended Probe**

Double-ended / 7" (18 cm)

508-547



508-547



 Sontec Instruments®

Orthopedic MALLETS

**Sontec Combo Nylon Mallet**

1" head diameter / removable heads / 7 3/8" (18.75 cm)

- 1100-462S removable nylon head
- 1100-463 nylon head for mallet 1"
- 1100-463S nylon head for new style mallet

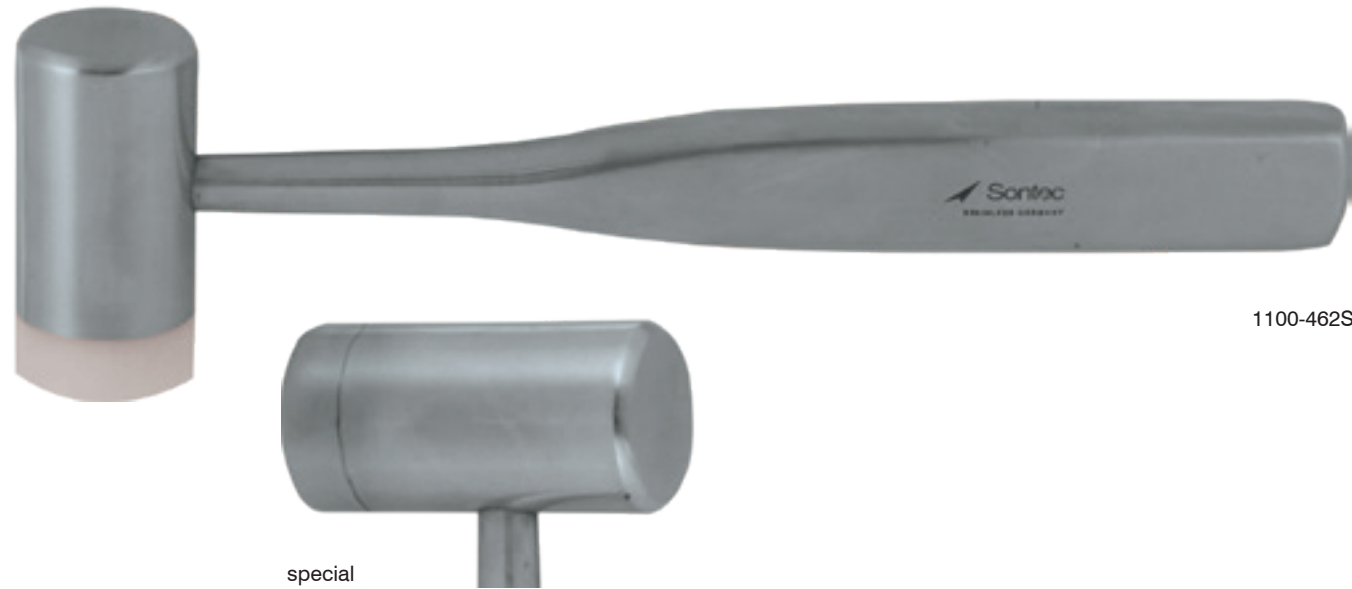

1100-462S

special stainless head  
\*available upon request

**Collin Lucae Mallet**

Solid head / 210 grams / 30mm Ø / 8 1/4" (21 cm)

330-818



330-818

**Sontec Double Nylon Mallet**

Light-weight / 7 3/8" (18.7 cm) / 7 oz.

330-808



**Sontec Micro Mallet**

3/4" head diameter / 5 oz / 6 1/2" (16.5 cm)

- 330-817 stainless steel convex/flat combo
- 330-819 lead filled head no recoil



330-817



 Sontec Instruments®

Orthopedic SINGLE ACTION RONGEURS

**Mini Neuro Rongeur**

5 1/2" (14 cm)

- 1106-080 str 0.75 mm jaw
- 1106-082 cvd 0.75 mm jaw
- 1106-084 str 1.0 mm jaw
- 1106-086 cvd 1.0 mm jaw
- 1100-577S str 1.3 mm jaw
- 1100-577 cvd 1.3 mm jaw



1100-576

1.4 mm jaw / 6" (15 cm)

- 1100-574 str
- 1100-576 cvd

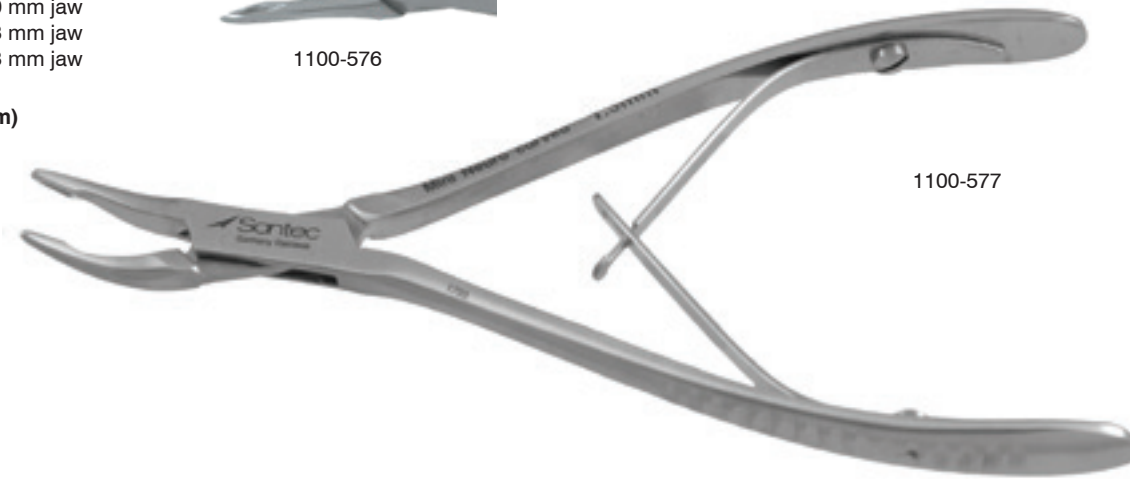

1100-577

**Mini Neuro Premier Rongeur**

0.5 mm tip / 5 1/2" (14 cm)

- 1106-091 str
- 1106-092 cvd



1106-091



1106-092

**Micro Friedman Ring Handle Rongeur**

5 1/2" (14 cm)

- 1106-076 1.3 mm straight
- 1106-077 1.3 mm curved
- 1106-078 1.3 mm full curved
- 1106-079 2.0 mm curved
- 1106-0791 2.0 mm full curved

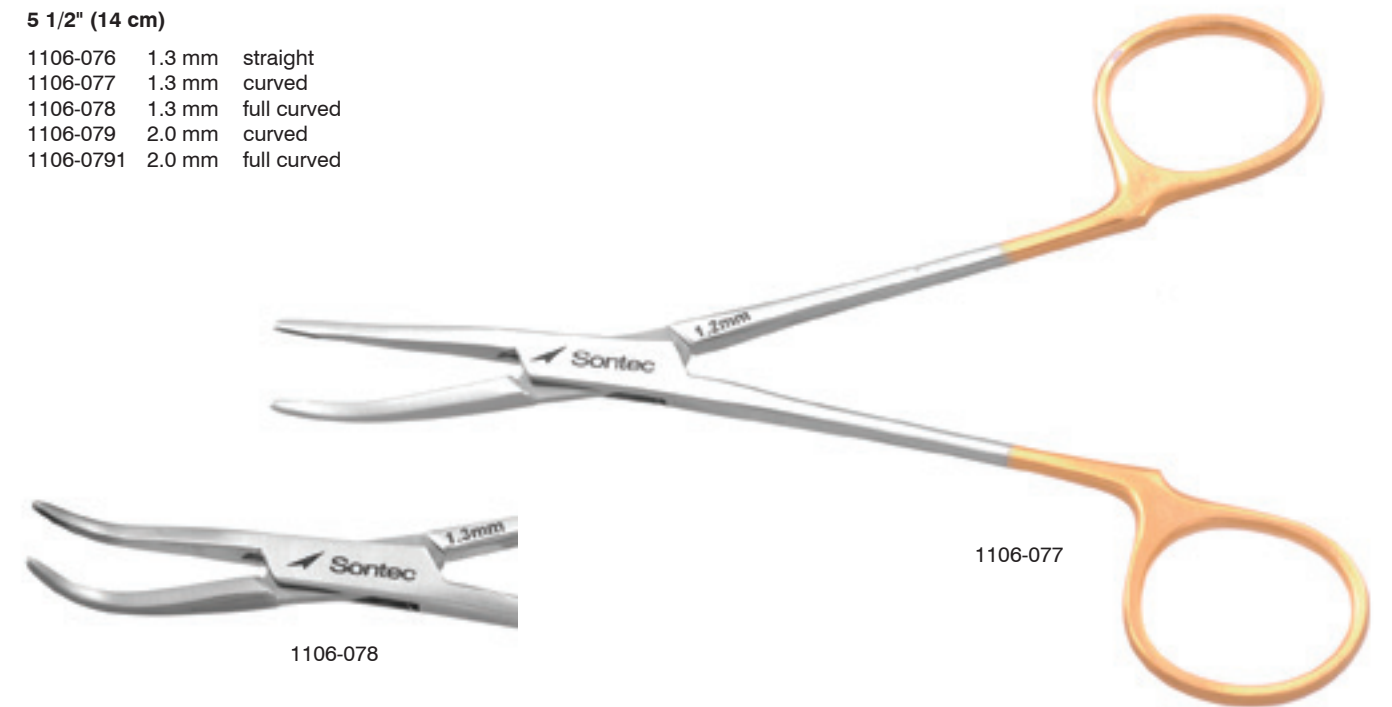

1106-077



1106-078



1106-079



1106-0791

**Kleinert-Kutz Rongeur**

2 mm x 6 mm jaw / 5 1/4" (13 cm)

- 315-581 slight curve
- 315-580 full curve



315-581



315-581



315-580

**Micro Friedman Rongeur**

1.5 mm x 5 mm jaw / 5 1/2" (14 cm)

- 315-505S str
- 315-505C 30° angle
- 315-505 90° angle

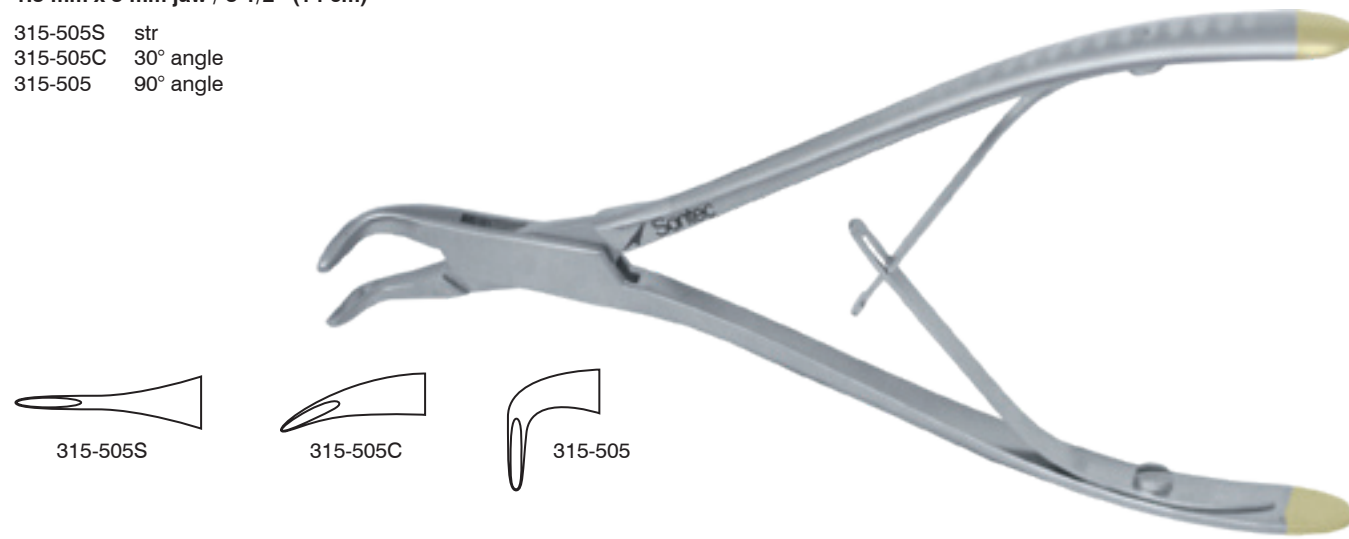

315-505

**Mini Friedman Rongeur**

2 mm x 8 mm jaw / 5 1/2" (14 cm)

- 1106-070 str
- 1106-075 cvd



1106-075

**Shearer Chickenbill Rongeur**

Curved / 3 mm x 12 mm jaw

- 315-511 5 1/2" (14 cm)
- 315-513 6 1/2" (16.5 cm)
- 315-515 7" (18 cm)



315-511

**Hakansson Rongeur**

2.5 mm x 12 mm jaw / curved / 6 1/4" (16cm)

- 1103-230



1103-230



**Stellbrink Rongeur**

2 mm x 8 mm jaw / 6 1/2" (16.5 cm)

- 315-566 slight curve
- 315-567 full curve

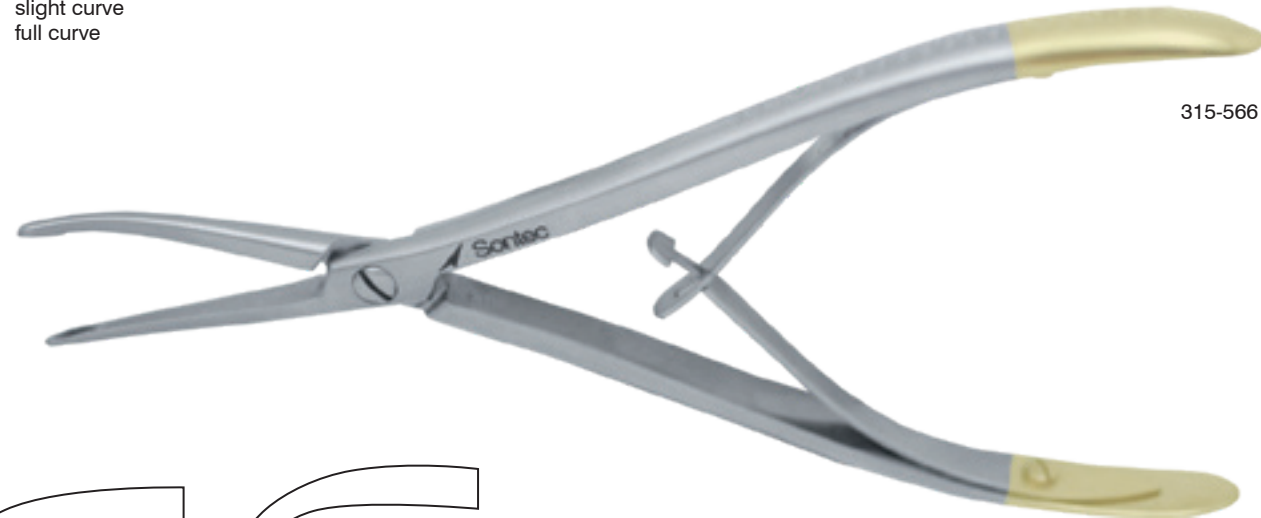

315-566

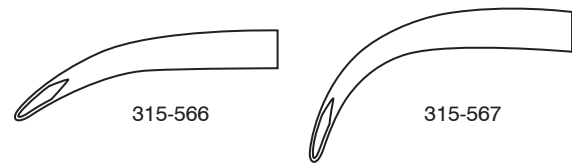

315-566

315-567



315-567

**Classic Lempert Rongeur**

2.5 mm x 10 mm jaw

- 315-542 straight 6 1/4" (16 cm)
- 315-544 curved 6 1/4" (16 cm)
- 315-548 straight 7 1/2" (19 cm)
- 315-550 curved 7 1/2" (19 cm)

\* Additional Rongeurs available. Please call for styles, sizes & details



315-544



straight

curved

**Sontec Lempert Rongeur**

2.5 mm jaw / 6 1/2" (16.6 cm)

- 1100-542 straight
- 1100-544 curved

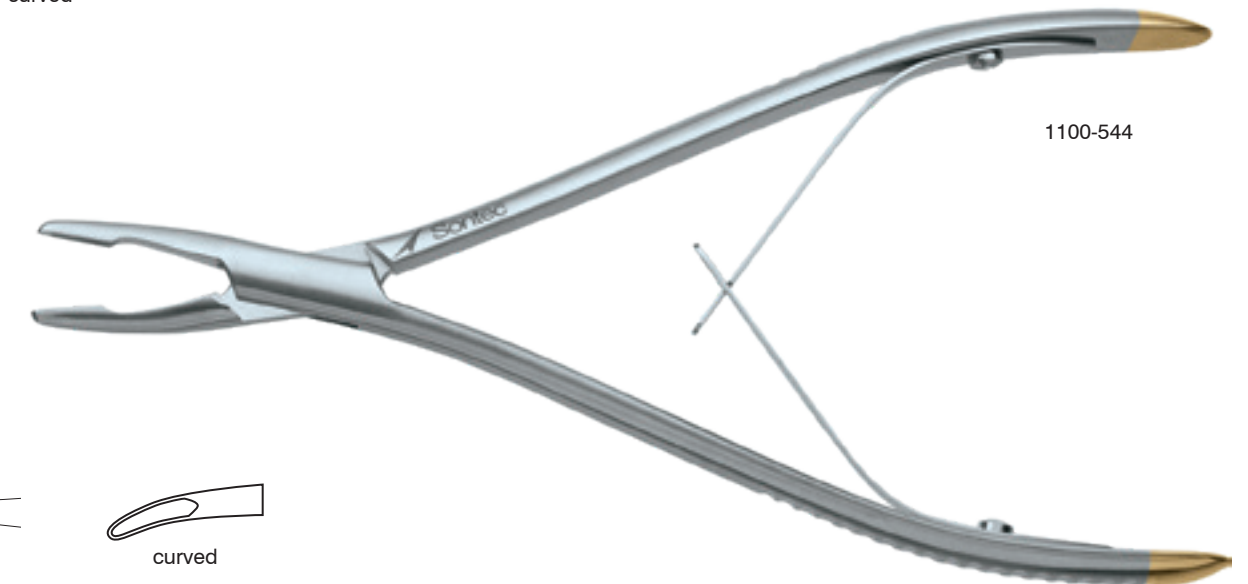

1100-544



straight

curved

**Jeurs Lempert Neuro Rongeur**

Curved to side / 2.5 mm jaw / 7 1/2" (19 cm)

1100-578

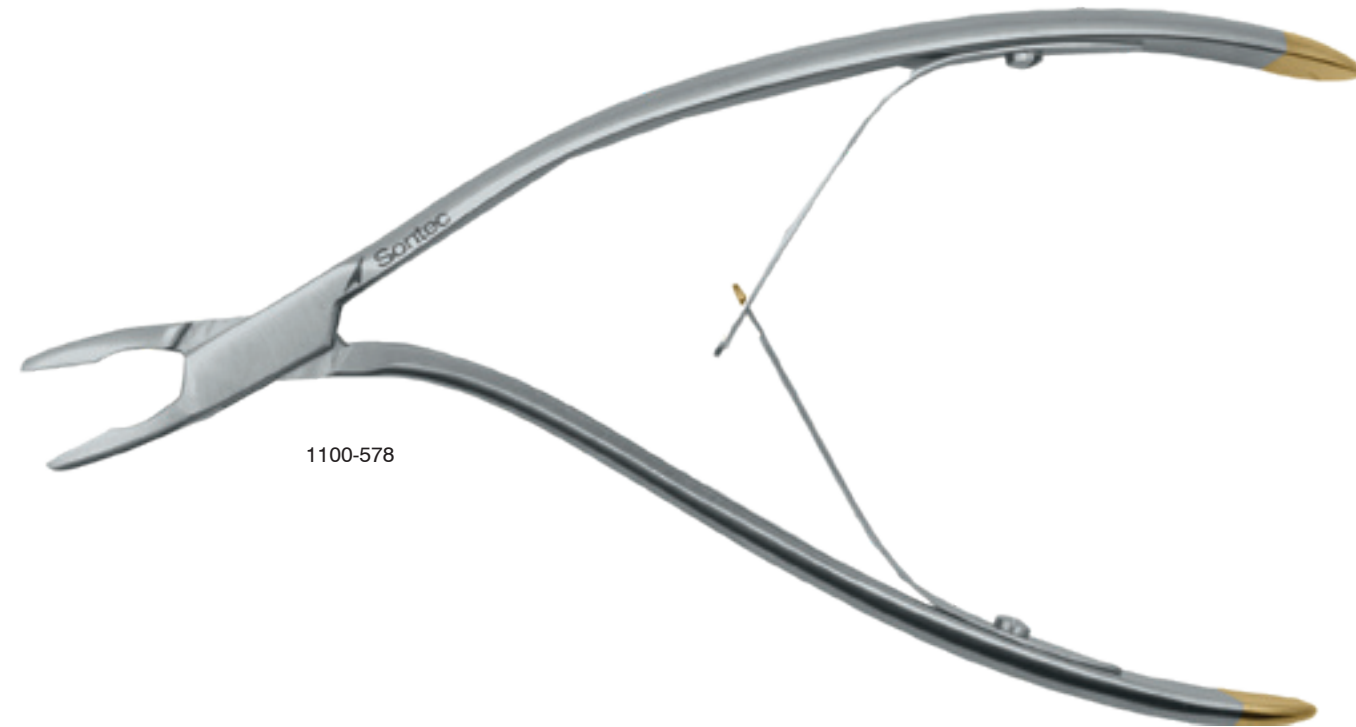

1100-578

**Levesque Neuro Rongeur**

Curved to side / low profile / extra delicate / 1.3 mm jaw / 7 1/2" (19 cm)

1100-578A

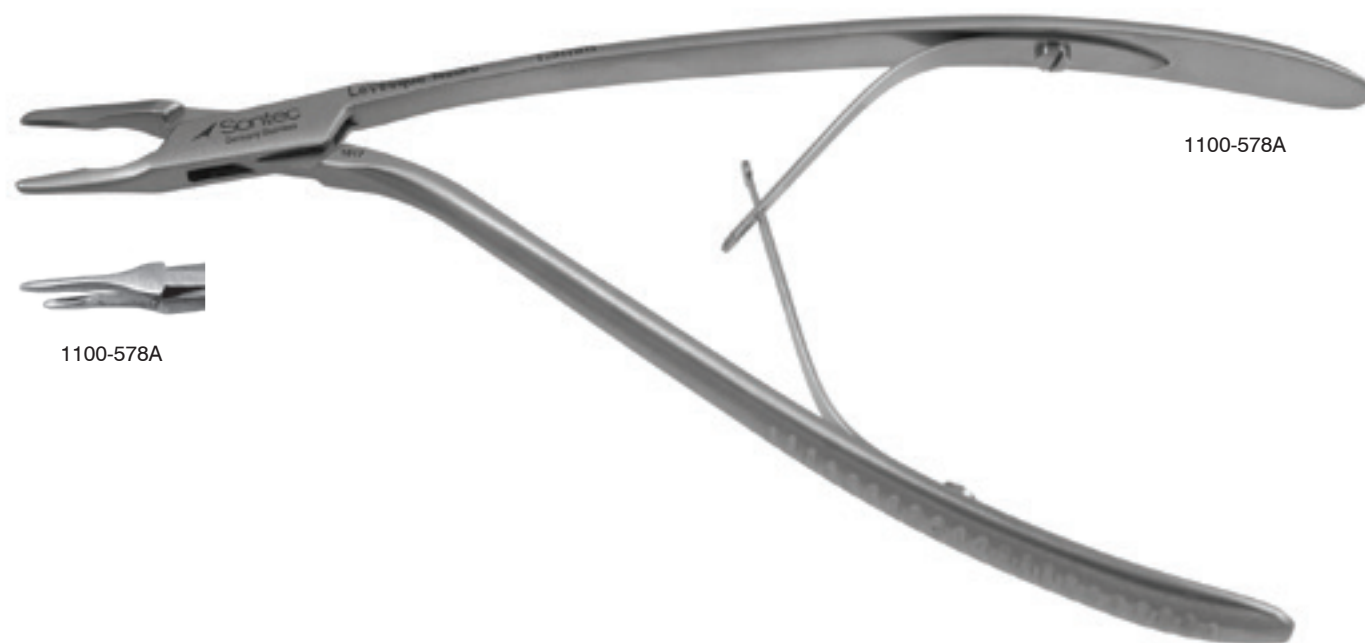

1100-578A

1100-578A

**Cicherelli Rongeur**

3 mm x 12 mm jaw / full curve / 6 1/2" (16.5 cm)

315-559



315-559

**Cleveland Rongeur**

Curved

315-526 5 1/2" (14 cm)

315-527 6 3/4" (17cm)



315-527

**Defourmentel Rongeur**

Straight / 7" (18 cm)

315-524

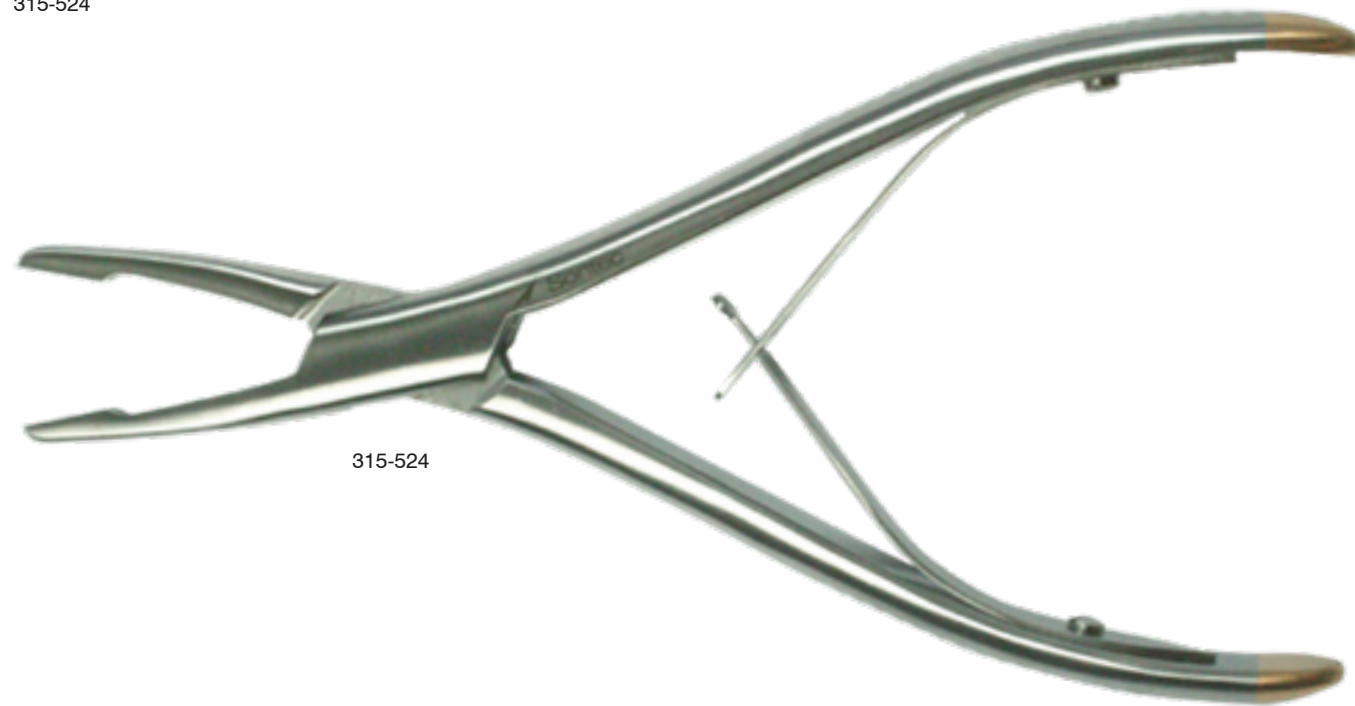

315-524

**Bacon Duckbill Rongeur**

Single-action / curved to side / 4.5 mm x 14 mm jaw / 8" (20 cm)

315-569



315-569



**Hartman Rongeur**

4.5 mm x 12 mm jaw / 5 3/4" (14.5 cm)

- 315-530 str
- 315-532 half curve
- 315-534 full curve

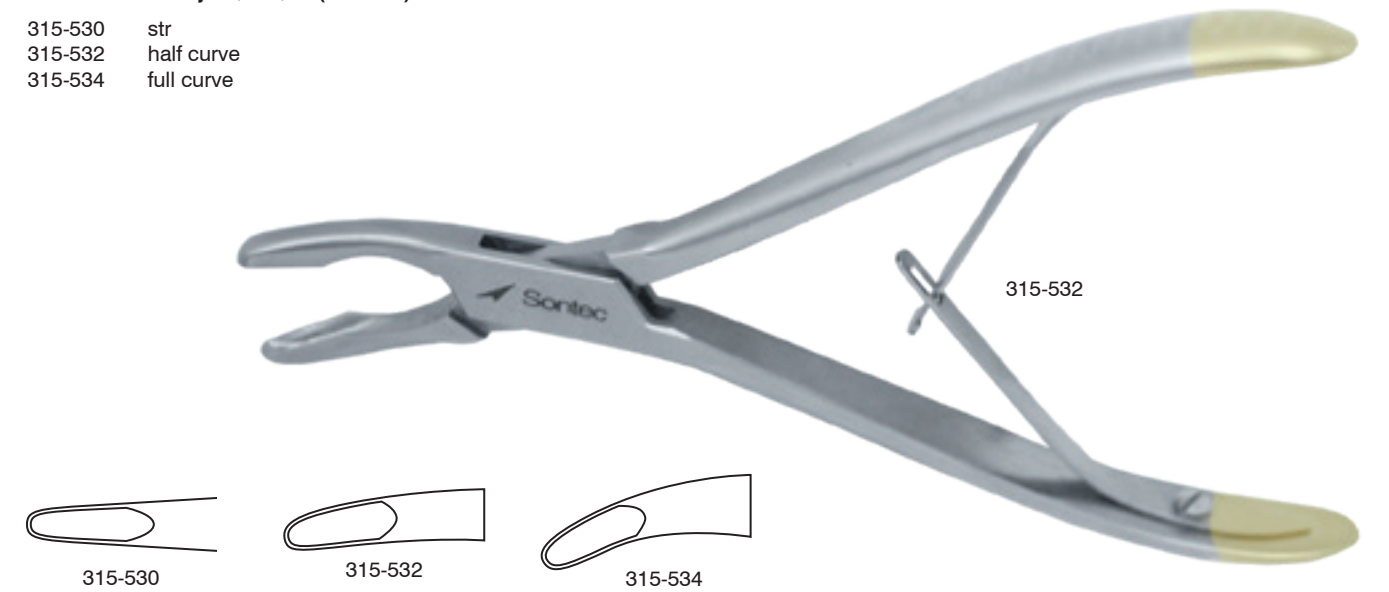

**Cushing Rongeur**

6 mm x 14 mm jaw / 8" (20.5 cm)

- 315-574 straight
- 315-576 curved

Serrated jaw / 6 mm x 14 mm jaw / 8" (20.5 cm)

- 315-572 straight
- 315-573 curved

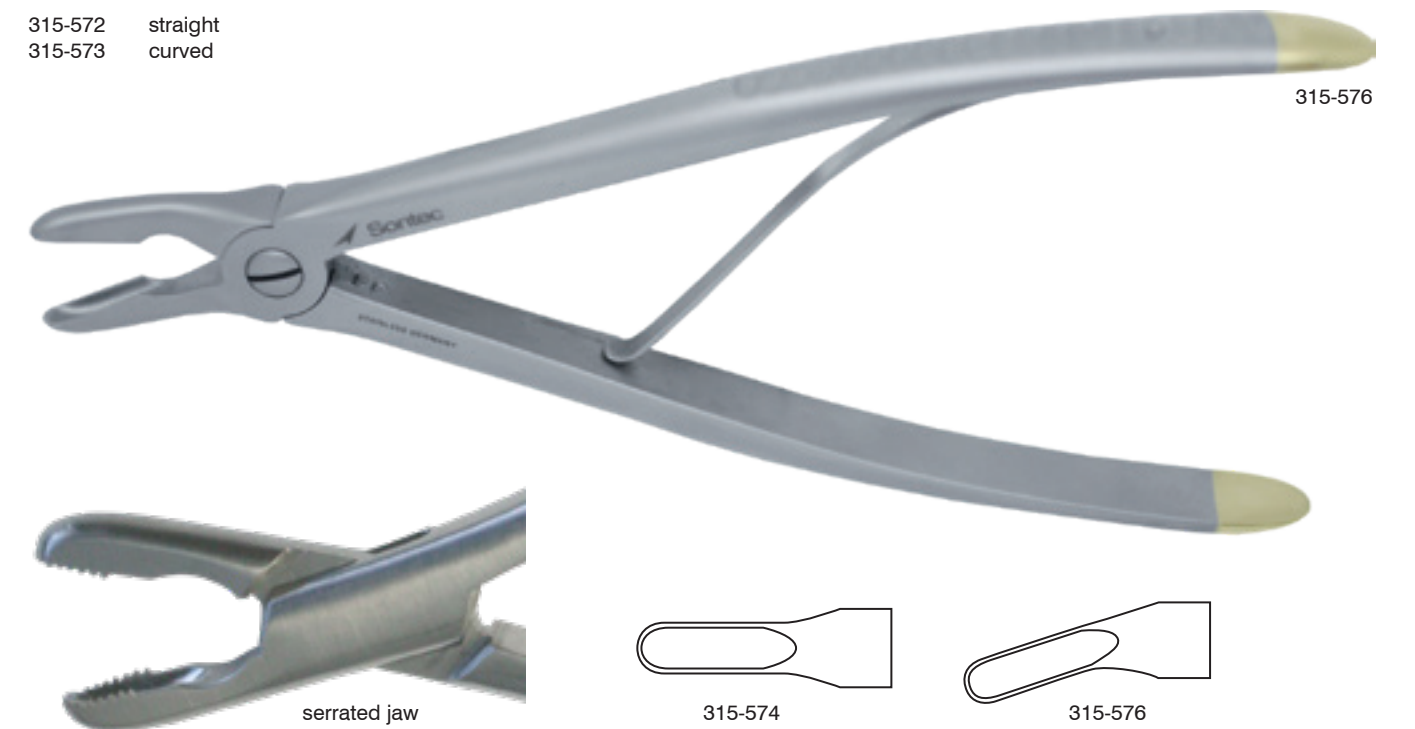

serrated jaw

315-574

315-576

**SONTEC MINIMAL INVASIVE SURGICAL INSTRUMENTATION**  
FINEST QUALITY IN THE INDUSTRY / AGGRESSIVE PRICING



1. Hook Scissors 4.5 mm / 1271-470
2. Kerrison Endoscopic / 404-60825E
3. Velocaptor Jr. 2.7 mm / 1273-171
4. Cannula with Stopcock 3.2 mm / SC95-0315
5. Biopsy Grasper with Ratchet / 1271-020R
6. MIS Micro 20 Gauge Scissors / 13-5600
7. Micro Scissors Large Gauge / 13-5710
8. Micro Neuro Bayonet Scissors / 2900-016

**DID YOU KNOW?**

Sontec specializes in MIS instruments including but not limited to: Laparoscopic, Thoracoscopic, Microdissection, Endoscopic Neuro/Brain Surgery, Arthroscopy, Vitrectomy and Intraocular instrumentation designed for the future of surgery.

9. MIS Scissors 15° Axial / 2800-230
10. MIS Cannula Trocar / 20907-17
11. Atraumatic Forceps 3 mm / 2901-201
12. Axial Handle with Spring and Ratchet / 2901-076
13. Atraumatic Forceps 5 mm / 2901-245S
14. Axial Ring Handle / 2901-070
15. Dissecting Forceps without Ratchet / 2100-933

**Sontec Instruments®**

A TRADITION OF FINE SURGICAL INSTRUMENTS

Colorado / USA / 800.821.7496

www.SontecInstruments.com



**SONTEC SURGICAL ARMAMENTARIUM**  
FINEST QUALITY IN THE INDUSTRY / AGGRESSIVE PRICING



Offering more than 12,000 individual instruments covering the entire human anatomy including instruments specifically designed for veterinary medicine.

1. Classic Neuro Hangeur / 315-544
2. 1x2 Ophthalmic Forceps (select tooth size) / T14-2820
3. Velocaptor Jr. Arthroscopic Forceps / 1273-171
4. Bipolar Non-stick Bayonet Forceps / 2700-852NS
5. Doolen Bone Clamp / 1103-848R
6. Delux-Sontec OlsenHeger / 1100-106B
7. Eye Wire Barraquer Speculum / T10-1010
8. 1mm Wire Cutter Angled Jaws / 1103-115
9. Baby Poole Suction / 180-420
10. Unique Freer Suction Elevator / 2700-310
11. Chelation Clamp / 14-9901
12. 6" Biopsy Cup Forceps / 469-084
13. Bone Rasp Miller / 1100-490
14. Sontec Osteotome (select mm size or order set) / 330-804M
15. Ceramic Cut Westcott Scissors / 13-3304B
16. 8 French Frazier Suction / 412-682
17. Micro Needle Holder T.C. / 15-3960

**Sontec Instruments®**

A TRADITION OF FINE SURGICAL INSTRUMENTS

Colorado / USA / 800.821.7496

www.SontecInstruments.com



# SONTEC INSTRUMENTATION OF EXPERTS

FINEST QUALITY IN THE INDUSTRY / AGGRESSIVE PRICING

1. Martinez Dissector - 1-1-3420
2. Lasic Flap Spatula - 12-2860
3. Kelly Membrane Punch 1.0 mm - 11-9270
4. 0.12 Colibri with Angled Teeth - 14-2820
5. Fine Stitch Scissors - 13-4800
6. Manhattan 0.3 mm Forceps - T14-3060
7. Serrafine Clamp - 14-9940
8. Desmarres Lid Retractor - 10-4200
9. Masker Capsulathexis Forceps - 14-5394
10. Rizzuti Iris Retractor and Lens Expressor 2 mm - 12-4800
11. Castroviejo TC Needle Holder - 15-1910
12. Bishop Harmon Forceps 0.5 mm - T14-3805
13. Silicone Eye Sphere
14. Fomon Enucleation Scissors - 508-622
15. Micro Interocular Biopsy Forceps - 14-7751
16. 7" Ceramic TC/PC Metzenbaum Scissors - 1200-915
17. Full Curved Iris Forceps 1 x 2 0.8 mm - 14-4455
18. Singer Capsule Sweep/Polisher - T12-2660
19. Gerrard Fixation 1 x 2 Forceps 0.5 mm - 1-4-3260E
20. Cook Speculum Medium - 10-1402
21. Gracile Scissors - 199-550
22. Severin Clamp Medium - 14-9907
23. Eye Shield Plastic - 1100-409M
24. Suction Cup (for above item) - 18-8028
25. Tissue Forceps Bipolar Nonstick - 2700-864NS



**Sontec Instruments®**

A TRADITION OF FINE SURGICAL INSTRUMENTS

Colorado / USA / 800.821.7496

www.Sontecinstruments.com



# SONTEC EXPERTS OF INSTRUMENTATION

FINEST QUALITY IN THE INDUSTRY / AGGRESSIVE PRICING

1. Verges Phaco Chopper - 12-1407
2. Stevens Ergonomical Scissors - 1200-708
3. Castroviejo Colibri - 14-2200
4. Pigall Probe with Holes - 16-2600
5. Easy Change Phaco I/A Cannula System - 16-3100
6. 0.5 mm 90° Phaco Tip - 16-3103D
7. Plastic Eye Shield - 1100-409L
8. Thorpe Caliper - 12-9400
9. Eye Shield Set - 18-8026
10. Serrafine - 14-9985
11. Castroviejo Retractor - 10-1701C
12. Trautman Scissors - 13-1510
13. Silicone Eye Spheres
14. Gill Vanass Scissors - 13-5415
15. Barraquer Speculum - T10-1010
16. Kaye Scissors - 1200-072
17. Tennant Forceps - 14-5570
18. Micro Alligator - 469-040
19. Sheppard Lens Forceps - T1-48940
20. Wilder Lens Loop - 12-4402
21. 20 Gauge Vitrectomy Scissors - 13-5600
22. Gratie Fixation Forceps - 14-5122
23. Paton Spatula with Spoon - 12-4550
24. Reeh Sitch Scissors - 13-9325
25. Jewelers Bipolar Nonstick - 2700-924
26. Anis Needle Holder - 15-3830
27. Jaffe Forceps - T14-5590



**Sontec Instruments®**

A TRADITION OF FINE SURGICAL INSTRUMENTS

Colorado / USA / 800.821.7496

www.Sontecinstruments.com



# PLASTILOGICAL INSTRUMENTATION

FINEST QUALITY IN THE INDUSTRY / AGGRESSIVE PRICING

- 1. Cottle Crusher 350-849
- 2. Gillies 132-384C
- 3. Davis 412-767
- 4. Sartec 3mm 1100-479M
- 5. Lacrimal Probe 16-2510
- 6. Westcott 13-3306
- 7. Desmarres 10-4220
- 8. Kahn Face Lift Scissors 475-175



- 9. Eye Shield 1100-409M
- 10. Eye Shield Pair 18-8020
- 11. 2 mm 40° Kerrison 404-491
- 12. Desmarres Electro Blue 14-9908
- 13. Bipolar Suction Forceps 2700-817
- 14. Joseph 16-2210
- 15. 0.5 Castroviejo 14-2820
- 16. Cottle 6 mm 330-849C

- 17. Putermann 714-9400
- 18. Jewellers 14-6840
- 19. Mini Neuro 1106-086
- 20. Silicon Eye Spheres 1100-411-23
- 21. Joseph Hook Electro Blue 199-432
- 22. Stevens 1200-497
- 23. Sphere Introducer 17-1000
- 24. Castroviejo 15-1910

**Sartec Instruments®**

A TRADITION OF FINE SURGICAL INSTRUMENTS

Colorado / USA / 800.821.7496

www.Sartecinstruments.com



# NECESSARY SELECTIONS

FINEST QUALITY IN THE INDUSTRY / AGGRESSIVE PRICING



- 1. Westcott with wide grip - 13-3301
- 2. 0.5 Bishop Harmon - T14-3805
- 3. Ceramic Stevens - 1200-930
- 4. Jewellers #4 - 2200-0014
- 5. Barraquer - T10-1030
- 6. Barraquer - T10-1005
- 7. Colibri 0.12 fluted handle - 14-5395
- 8. Castroviejo speculum - 10-1703C
- 9. Derr TC - 132-364
- 10. 2.5 mm Burr - 11-4612
- 11. Easy Change Handle - 16-3100
- 12. 0.5 Binkhorst - 16-3107B
- 13. Strabismus Power Cut - 1200-023
- 14. Manhattan 0.3 - T14-3060

**Sartec Instruments®**

A TRADITION OF FINE SURGICAL INSTRUMENTS

Colorado / USA / 800.821.7496

www.Sartecinstruments.com

# TAKAHASHI RONGGEURS

FINEST QUALITY IN THE INDUSTRY / AGGRESSIVE PRICING



1. Straight - 404-787 / 2.5 mm x 10 mm jaw cup / 4 1/2" (11.5 cm) shaft
2. Straight - 404-788 / 2.5 mm x 10 mm jaw cup / 5 1/2" (14 cm) shaft
3. Straight - 404-7875 / 3.5 mm x 10 mm jaw cup / 4" (10 cm) shaft
4. Straight - 404-7871 / 2.5 mm x 10 mm jaw cup / 5 1/2" (14 cm) shaft
5. Up-angled - 404-788U / 3 mm x 10 mm jaw cup / 4 1/2" (11.5 cm) shaft

Select from a variety of jaw sizes, angles and shaft lengths. Peapods offer the perfect jaw design for tight small and hard to navigate joint areas!

**Sontec Instruments®**

A TRADITION OF FINE SURGICAL INSTRUMENTS

Colorado / USA / 800.821.7496

www.SontecInstruments.com

# NEUROSURGICAL INNOVATION

BY THE LEADER IN INSTRUMENTATION / FINEST QUALITY IN THE INDUSTRY / AGGRESSIVE PRICING



1. Decker Rongeur 469-057
2. Sontec Tapered S-Retractor 207-417
3. Micro Axial Bayonet Scissors 2900-022
4. 3 mm Tumor Grasping Forceps 400-075
5. Jacob Bayonet Needle Holder TC Round Handle Curved Jaws 400-229
6. Bayonet Foraminotomy Kerrison 404-468
7. Micro Axial New Large Gauge Handle Needle Holder 2900-004
8. Suction Monopolar Silver Non-Stick 2700-554NS

9. Neuro Jacobson Scissors 2400-6500
10. Dissector 412-550T
11. Axial Curette 320-886D
12. Dissecting Suction Elevator 478-360
13. Dissecting Suction Elevator 2700-310
14. Brain Spatula 2 mm 412-779
15. Elevator with Suction 478-375
16. Dissector Curette 412-547T
17. Dissector Wax Packer 412-549

**Sontec Instruments®**

A TRADITION OF FINE SURGICAL INSTRUMENTS

Colorado / USA / 800.821.7496

www.SontecInstruments.com



# CeramiTec

FINEST QUALITY IN THE INDUSTRY / AGGRESSIVE PRICING

Sontec's **CeramiTec** line of unique instrumentation is identified at first glance by its bold jet black surface with bright gold lettering for easy recognition and reordering. **CeramiTec** is designed to reduce friction which prolongs the sharpness of a scissors' blades. Please visit [SontecInstruments.com](http://SontecInstruments.com) to view all **CeramiTec** products. You may also request a printed catalog.



- 1. Bandage Scissors / 1200-980
- 2. Metzenbaum / 1200-915 3. Freeman / 1200-970
- 4. Dissector 45° / 413-003 5. Micro Hook / 413-010
- 6. 5 mm Hook 90° / 413-017 7. 7 mm Probe 45° / 413-019
- 8. Curved Dissecting Spatula / 413-004 9. Baby Metzenbaum / 1200-922
- 10. Iris Scissors / 1200-950 11. Metzenbaum 5 3/4" / 1200-911 12. Stevens 4 1/2" / 1200-930
- 13. Jabaley / 1200-940 14. Baby Metzenbaum Spread Handle / 1200-899 15. Stevens 4 1/4" / 1200-929
- 16. Westcott / 13-3304B 17. Stevens Spread Handle / 1200-935 18. Jacobson / 2400-683B

## Sontec Instruments®

A TRADITION OF FINE SURGICAL INSTRUMENTS

Colorado / USA / 800.821.7496

[www.SontecInstruments.com](http://www.SontecInstruments.com)



# SONTEC ELECTRIFIED BIPOLAR

FINEST QUALITY IN THE INDUSTRY / AGGRESSIVE PRICING

Creating non-stick ceramic & silver electro cautery instrumentation



**CERAMIC**  
inlaid blades provide an incredible smooth cut.



**FORCEPS**  
all shown are available in a variety of lengths, tip sizes and angles. Choose wide or classic grip.



- 1. Bayonet Wide Grip Forceps - 2700-852NS
- 2. Bayonet Wide Grip with Suction - 2700-817
- 3. Bayonet Wide Grip Forceps - 2700-837NS
- 4. Bipolar Non-Stick Frazier Suction - 2700-552NS
- 5. Adson 5-Hole Forceps - 2700-908NS 6. Metzenbaum Scissors 2700-5331
- 7. Cushing Tissue Forceps - 2700-864NS 8. Cushing Forceps 2700-995NS
- 9. Metzenbaum Scissors 2700-5371 10. Jensen Bayonet Classic Grip Forceps 2700-881NS
- 11. Metzenbaum Scissors 2700-5431 12. Bayonet Wide Grip Forceps 2700-844NS

**NEW** **WIDE GRIP HANDLE**  
offers yet another option to surgeons by providing more handle space to articulate the non-stick silver tips

## Sontec Instruments®

A TRADITION OF FINE SURGICAL INSTRUMENTS

Colorado / USA / 800.821.7496

[www.SontecInstruments.com](http://www.SontecInstruments.com)

**EUROPEAN PLUG**  
connections available upon special order



HERCULES  
AND THE  
POWER OF  
THE GREEK  
GOD'S CAN  
BE IN YOUR  
HANDS



- 1. Wire Cutter  
9" - 355-189 / 11" - 355-191
- 2. TC Blades Replacement Set  
9" - 355-190 / 11" - 355-192
- 3. Rubber Jaws Replacement Set  
9" - 355-193 / 11" - 355-193

**Sontec Instruments®**

AUTHORIZED DEALER  
OF LIGHTS & LOUPES

A TRADITION OF FINE SURGICAL INSTRUMENTS

Colorado / USA / 800.821.7496

www.Sontecinstruments.com

# UNIVERSAL KLICK KERRISON SET

FINEST QUALITY IN THE INDUSTRY / AGGRESSIVE PRICING



- 1. 5 mm 40° 404-6085
- 2. 3 mm 40° 404-6083
- 3. 2 mm 90° 404-6072
- 4. 1 mm 40° 404-6081
- 5. Endoscopic Shaft 2.5 mm 40° 404-60825E
- 6. Bealy Foaminotomy  
Curved Down 2 mm 40° 404-6082C
- 7. Bealy Foaminotomy  
Curved Up 2 mm 40° 404-6082
- 8. Universal Klick Kerrison Handle 404-606
- 9. Bealy Foaminotomy  
Curved Up 3 mm 40° 404-6083B
- 10. Endoscopic Shaft 2 mm 40° 404-6083E
- 11. Endoscopic Shaft 3 mm 40° 404-6083EB
- 12. Bayonet Shaft 3 mm 40° 404-6083B

- 360° 8-point rotation
- Built in ejector pin on all shaft designs

**Sontec Instruments®**

A TRADITION OF FINE SURGICAL INSTRUMENTS

Colorado / USA / 800.821.7496

www.Sontecinstruments.com

# ELITE WIRELESS LED HEADLIGHT

FINEST QUALITY IN THE INDUSTRY / AGGRESSIVE PRICING



Wrap around rear cranial support on headband for added comfort. Removable if needed



Easy change battery fixture holds one battery while the backup is charging

100-5500

Rheostat control  
0-30,000 Lux  
at 16"/40 cm  
working distance

Battery indicator /  
Low battery indicator

Removable / sterilizable  
lever to safely adjust  
beam direction

Rheostat for spot  
variability 20-110 mm  
at 16"/40 cm working  
distance

Ideal color  
temperature  
at 4,500° K

Sold with 2 batteries, each with  
4 hours of power at 100% output  
and a lightweight carrying case

Designed to remove shadows  
in complex surgical operations

- Cardiovascular
- Orthopedic
- Spinal
- Abdominal

**Sontec Instruments**

# UNIVERSAL KERRISON SET

FINEST QUALITY IN THE INDUSTRY / AGGRESSIVE PRICING



404-608-SET Set

Classic Standard Set includes:

404-6081	1 mm 40° 8" shaft
404-6082	2 mm 40° 8" shaft
404-6083	3 mm 40° 8" shaft
404-6084	4 mm 40° 8" shaft
404-6085	5 mm 40° 8" shaft
404-6086	2 universal handles

18-3564 tray only

To configure you own personalized set,  
refer to "Kerrison Section" > "Kerrison  
Universal Rotating 360° Rongeur" for  
all possible options

\*different size shafts available up request

**Sontec Instruments**

Product update: **HEINE® LoupeLight 2**

With HEINE HR or HRP Binocular Loupes for a perfect view.

The combination of light and loupe delivers the ultimate in performance as high quality illumination with LED<sup>HQ</sup> maximises the image quality of the loupe.

For a perfect view and a precise diagnosis, the LoupeLight 2 is now 25% brighter than its predecessor model, with a homogeneous edge-to-edge illumination of typ. 55,000 lux.

For intensive use, the LoupeLight 2 now features a replaceable connecting cord which connects the device to the mPack mini – the new and compact power source for the LoupeLight 2 (product description see overleaf).

**NEW!**  
 ✓ Now 25% brighter due to improved LED technology  
 ✓ Replaceable connecting cord



Replaceable connecting cord with high-quality splashproof threaded connector for heavy duty use.

Now even 25% brighter

**LED<sup>HQ</sup>**  
 LED NOW IN HEINE QUALITY.



HR 2.5x High Resolution Binocular Loupes. Achromatic optics for crisp, bright images.

Product update: **HEINE® MicroLight 2**

Ultralight, universal headlight.

For those who need a compact, lightweight illumination solution without magnification, we offer the MicroLight 2. Featuring LED<sup>HQ</sup> illumination for homogeneous illumination with true and natural colour rendering for every examination situation. Two mounting options offer individuality and easy handling. Illumination without compromises, in a lightweight design.



HEINE MicroLight 2 on S-FRAME



HEINE MicroLight 2 on Lightweight Headband

See overleaf for ordering information.



**HEINE® mPack mini** – The compact and light power source for LoupeLight 2 and MicroLight 2.

The new, high performance power source HEINE mPack mini for LoupeLight 2 and MicroLight 2 offers freedom from cables that tie the users to desk, wall or static power sources. With a weight of just 95g and dimensions of 44 x 23 x 101 mm, this mobile power source is now approximately approx. 70% smaller and lighter than its predecessor.

The pouch, which is included in the delivery, can be attached to the belt. The mPack mini can also be charged whilst in the pouch. Thanks to the LI-ion battery technology the power source has an operating time of typ. 9 hours, in continuous operation at maximum power typ. 4 hours. The mPack mini is flexible in charging due to its USB connector. Charge it via laptop, desktop or USB charger.

**NEW!**  
 ✓ 70% smaller and lighter  
 ✓ Operating time typ. 9 hours  
 ✓ Charging time typ. 4 hours



USB charging option



Size comparison of HEINE mPack LL/mPack mini

LoupeLight 2 Sets with HR Binocular Loupes	
HR 2.5x optics with i-View on S-FRAME, LoupeLight 2, detachable yellow filter, mPack mini, mPack mini Belt Clip, E4-USB plug-in transformer, protective lenses, 2 sterilisable levers, retaining cord, cleaning fluid, cleaning cloth, carrying case	
340mm working distance	C-008.32.450
420mm working distance	C-008.32.451
520mm working distance	C-008.32.452
MicroLight 2 Sets	
MicroLight 2 on S-FRAME with mPack mini, mPack mini Belt Clip, E4-USB plug-in transformer, retaining cord and cleaning fluid in case	J-008.31.276
MicroLight 2 on Lightweight Headband with mPack mini, mPack mini Belt Clip, E4-USB plug-in transformer, case	J-008.31.277
Single Devices	
LoupeLight 2 for HR/HRP Loupes with i-View loupe mount	C-008.32.226
mPack mini with LI-ion rechargeable battery and E4-USB plug-in transformer	X-007.99.650
mPack mini with LI-ion rechargeable battery, without E4-USB plug-in transformer	X-007.99.649
Connecting cord SC1 (1.6m) for LoupeLight 2 or MicroLight 2/mPack mini	C-000.32.240

For further ordering information please contact your HEINE distributor **Sontec Instruments®**

**Sontec Instruments®**  
 7248 S. Tucson Way  
 Centennial, CO 80112  
 USA Headquarters  
 Heine USA



**HEINE Optotechnik GmbH & Co. KG**, Kientalstr. 7, 82211 Herrsching, Germany  
 Tel. +49 (0) 8152/38-0, Fax +49 (0) 8152/38-202, E-Mail: info@heine.com, www.heine.com



A-000500218 • 04/17  
 We reserve the right to change specifications without notice.  
 © 2018 HEINE Optotechnik GmbH & Co. KG. All rights reserved.

## Index

T10-1000	394	10-1300S	396	10-4530	383
T10-1000C	394	T10-1320	396	10-4535	383
T10-1005	394	10-1340	396	10-4600	330
T10-1010	394	10-1350	396	10-5400	386
T10-3825	384	10-1360	396	10-5480	387
T10-5480	387	10-1400	397	10-5487	387
T10-5487	387	10-1401	397	10-5489	387
T10-5489	387	10-1402	397	10-5491	387
T10-5491	387	10-1403	397	11-4560	388
T13-3417	50	10-1404	397	11-4600	388
T13-3418	50	10-1405	397	11-4601	388
T14-2220	110	10-1420	397	11-4609	388
T14-2800	110, 120	10-1422	397	11-4610	388
T14-2810	110, 120	10-3100	384	11-4611	388
T14-2830	110, 120	10-3140	384	11-4612	388
T14-2840	110, 120	10-3150	384	11-4613	388
T14-6805	92	10-3160	384	11-4614	388
T14-6820	92	10-3170	384	11-4615	388
T14-6830	92	10-3180	384	11-4616	388
T14-6840	92	10-3190	384	11-4617	388
T14-6850	92	10-3200	384	11-4618	388
T14-6860	92	10-3210	384	12-1285	150, 388
T14-9400	104, 105	10-3220	384	12-1290	150, 388
T14-9990	105	10-3310	384	12-1300	150, 388
T15-1800	67	10-3312	384	12-1310	150, 388
T15-1810	67	10-3314	384	12-1320	150, 388
T15-1820	67	10-3800	384	12-1355	150, 388
T15-1830	67	10-3810	384	12-1360	150, 388
T15-1860	67	10-3820	384	12-1365	150, 388
T15-1861	67	10-3825	384	12-1367	150, 388
T15-1880	67	T10-3840	384	12-1368	150, 388
T15-1881	67	10-3890	383	12-9300	308
T15-1912	69	10-4192	276, 385	12-9310	308
T15-1913	69	10-4194	276, 385	12-9315	308
T15-1914	69	10-4196	276, 385	12-9320	309
T15-1915	69	10-4198	276, 385	12-9330	309
T15-1916	69	10-4200	276, 385	12-9335	309
T15-1917	69	10-4201	276, 385	12-9340	311
T115-452	136	10-4206	276, 385	12-9400	310
T136-688	97	10-4207	276, 385	12-9450	310
10-1000	394	10-4210	276, 385	12-9500	313
10-1000C	394	10-4211	277, 385	12-9600	311
10-1005	394	10-4213	276, 385	12-9630	311
10-1010	394	10-4216	276, 385	13-3306	49
10-1010C	394	10-4220	276, 385	13-3307	49
10-1015	394	10-4221	277, 385	13-3400	49
10-1020	394	10-4223	276, 385	13-3401	49
T10-1020	394	10-4226	276, 385	13-4400	49
10-1030	394	10-4230	276, 385	13-4402	49
T10-1030	394	10-4231	277, 385	13-6800	31
10-1043	395	10-4233	276, 385	13-6810	31
10-1050	395	10-4236	276, 385	13-6815	31
T10-1051	395	10-4240	276, 385	13-7500	56
10-1053	395	10-4241	277, 385	13-7510	56
T10-1053	395	10-4245	277	13-7520	56
10-1054	395	10-4246	277	13-7522	56
T10-1054	395	10-4269	276	13-7524	56
10-1055	395	10-4270	276	13-7526	56
T10-1056	395	10-4501	383	13-7528	56
10-1062	395	10-4504	383	13-7530	56
10-1150	396	10-4520	383	13-7532	56
10-1300	396	10-4525	383	13-7533	56

13-7600	55	14-3260B	109	14-9894	103
13-7610	55	14-3260C	109	14-9895	103
13-7620	57	14-3260D	109	14-9900	103
13-7700	57	14-3800	110	14-9901	103
13-7710	57	T14-3803	110	14-9902	103
13-7715	57	14-3805	110	14-9906	103
13-7720	56	T14-3805	110	14-9907	103
13-7730	56	14-3810	110	14-9908	103
13-7740	58	T14-3810	110	14-9910	105
13-7750	58	14-3850	119	14-9920	105
13-7786	58	14-3860	119	14-9925	105
13-8805	50	14-4300	99	14-9930	107
13-8813	54	14-4305	99	14-9935	130
13-8814	54	14-4310	99	14-9940	130
13-8815	50	14-4340	99	14-9990	105
13-8820	50	14-4345	99	14-9992	105
13-8825	50	14-4350	99	15-0230	402
13-8865	50	14-4400	119	15-0231	402
13-8866	50	14-4410	119	15-0232	402
13-9805	59	14-4415	119	15-0233	402
13-9810	59	14-4440	119	15-1300	68
13-9820	59	14-4450	119	15-1300F	68
13-9822	59	14-4455	119	15-1310	68
14-2100	111	14-4600	109	15-1320	68
14-2110	111	14-4620	109	15-1320F	68
14-2220	110	14-4800	109	15-1330	68
14-2630	108	14-5120	101	15-1800	67
14-2800	110, 120	14-5122	101	15-1810	67
14-2805	110, 120	14-5130	101	15-1820	67
T14-2805	110, 120	14-5200	101	15-1830	67
14-2810	110, 120	14-5205	101	15-1860	67
14-2815	110, 120	14-5215	101	15-1861	67
T14-2815	110, 120	14-5220	101	15-1880	67
14-2820	110, 120	14-5240	103	15-1881	67
T14-2820	110, 120	14-6303	106, 119	15-1900	69
14-2830	110, 120	14-6310	107	15-1901	69
14-2840	110, 120	14-6400	106	15-1910	69
14-2860	110, 120	14-6415	106	15-1911	69
14-2880	110, 120	14-6445	107	15-1912	69
14-2890	108	14-6450	107	15-1913	69
14-2905	111	14-6500	106	15-1914	69
14-2920	111	14-6510	106	15-1915	69
14-2922	111	14-6560	94	15-1916	69
14-2935	111	14-6562	94	15-1917	69
14-2955	111	14-6564	94	16-2096	393
14-3050	108	14-6810	92	16-2097	393
T14-3050	108	14-6815	92	16-2098	393
14-3060	108	14-6816	92	16-2099	393
T14-3060	108	14-6820	92	16-2100	392
14-3070	108	14-6821	92	16-2101	392
T14-3070	108	14-6830	92	16-2102	392
14-3071	108	14-6831	92	16-2103	392
14-3072	108	14-6840	92	16-2104	392
14-3073	108	14-6850	92	16-2105	392
14-3075	108	14-6870	92	16-2106	392
14-3077	108	14-9400	104	16-2207	178
14-3150	109	14-9410	104	16-2208	178
14-3152	109	14-9700	101	16-2209	178
14-3154	109	14-9725	105	16-2210	178
14-3200	110	14-9730	102	16-2330	200
14-3210	110	14-9740	102	16-2332	200
14-3240	109	14-9750	102	16-2365	202
14-3245	109	14-9800	102	16-2368	203
14-3246	109	14-9850	102	16-2372	203
14-3247	109	14-9870	105	16-2374	203
14-3260A	109	14-9893	103	16-2376	203

16-2440	401	18-8025B	379	115-4461	134
16-2460	401	18-8026	379	115-4481	134
16-2470	401	18-8026B	379	117-500	143
16-2480	401	18-8028	379	117-500L	143
16-2500	401	18-8030	379	117-501	144
16-2510	401	18-8032L	379	117-503	144
16-2520	398	18-8032R	379	117-506	146
16-2530	398	18-8036	379	117-516	147
16-2530S	398	18-8037	379	117-517	147
16-2540	398	18-8301	312	117-518	145
16-2540S	398	48-0339	273	117-521	145
16-2541	398	48-0340	273	117-523	145
16-2550	398	110-260	33	117-524	146
16-2550S	398	110-308	34	117-560	9
16-2551	398	110-312	26	117-577	8
16-2560	398	110-313	26	117-578	8
16-2560S	398	112-478	57	117-588	9
16-2561	398	112-480	57	117-593	9
16-2570	398	112-580	25	117-5781	8
16-2570S	398	112-581	25	130-508	76
16-2571	398	112-582	25	130-514	82
16-2578	398	112-585	25	130-517	73
16-2579	398	112-602	31	130-518	73
16-2580	398	112-603	31	130-521	81
16-2581	398	115-310	135	130-523	81
16-2582	398	115-312	135	130-525	81
16-2583	398	115-316	135	130-526	81
16-2584	398	115-318	135	130-527	83
16-2585	398	115-320	135	130-529	83
16-2586	398	115-322	135	130-531	83
16-2587	398	115-400	132	130-563	71
16-2588	398	115-402	132	130-564	70
16-2589	398	115-404	132	130-565	70
16-2590	399	115-408	132	132-110	82
16-2592	399	115-410D	132	132-115	83
16-2594	399	115-412D	132	132-118	83
16-2596	400	115-422	133	132-120	83
16-2600	401	115-422M	133	132-122	83
16-3290	382	115-424	133	132-123	83
16-3300	382	115-425D	133	132-125	83
16-3310	382	115-426	133	132-210	81
16-3314	382	115-426D	133	132-212	81
16-3320	382	115-427D	133	132-214	81
16-3330	382	115-428	133	132-216	81
16-3346	382	115-428D	133	132-218	81
16-3348	382	115-429	133	132-223	81
16-3350	382	115-432	136	132-224	81
16-3800	382	115-434	136	132-225	81
16-3810	382	115-446	134	132-359	86
16-3820	382	115-448L	134	132-360	86
16-3821	382	115-450	136	132-361	86
16-3826	382	115-452	136	132-362	86
16-5300-SET	381	115-520	135	132-362D	86
16-5310	381	115-522	135	132-362S	86
16-5320	381	115-524	135	132-364	76
16-5321	381	115-526	135	132-365	76
16-5325	381	115-530	135	132-367	75
16-5330	381	115-532	135	132-367A	75
16-5331	381	115-534	135	132-372	73
16-5340	381	115-536	135	132-373	73
17-1000	381	115-538	135	132-374	73
18-8020	379	115-540	135	132-375	76
18-8020B	379	115-554	142	132-376	76
18-8022	379	115-556	337	132-376S	76
18-8022B	379	115-585	130	132-379	77
18-8025	379	115-586	130	132-379S	77

132-380	77	136-737	114	180-409	357
132-380S	77	136-740	113	180-410	357
132-381	77	136-742	114	180-411	357
132-381S	77	136-746	113	180-412	357
132-382	87	136-748	114	180-420	368
132-382L	87	136-798	115	180-422	368
132-383	87	136-6621T	96	180-424	368
132-383L	87	136-6741	97	180-432	366
132-384C	88	136-6891	95	180-433	366
132-384D	88	140-198	96	180-436	366
132-384L	88	140-201	96	180-439	366
132-387	87	140-202	93	180-440	366
132-388	81	140-203	93	180-447	367
132-450	71	140-207	93	180-448	367
132-632	76	140-220	116	180-449	367
132-634	76	140-220B	116	197-690	402
134-240	348	140-222B	116	197-691	402
134-242	348	140-297	97	197-692	402
134-243	350	140-298T	94	197-693	402
134-245	350	140-299	96	197-694	402
134-247	351	140-301	96	197-695	402
134-248	351	140-302	98	197-700	402
134-267	350	140-302D	98	197-701	402
134-268	351	140-302F	98	197-702	402
134-276	348	140-303	93	197-703	402
134-277	350	140-303F	98	197-704	402
134-277M	350	140-304	93	197-705	402
134-278	350	140-304F	93	199-129	152, 389
134-278M	350	140-304T	94	199-130	152, 389
134-280	350	140-305	93	199-131	152, 389
134-280M	350	140-305F	93	199-132	152, 389
134-281	350	140-306	93	199-133	152, 389
134-281M	350	140-307	93	199-136	152, 389
134-282A	350	140-309	93	199-300	153
134-282B	350	140-376	114	199-302	153
136-578	112	140-376B	117	199-304	153
136-580	112	140-378	114	199-306	153
136-659	94	140-379	114	199-308	153
136-659D	94	140-500	112	199-310	153
136-660	96	140-502	112	199-312	153
136-660A	96	140-517	114	199-314	153
136-661	96	140-517G	114	199-320	153
136-662	96	140-517M	114	199-322	153
136-662T	96	140-519	114	199-372	214
136-663	96	140-519G	114	199-375	221
136-664	97	140-519M	114	199-380	214, 219
136-664D	97	140-3032	93	199-382	214, 219
136-665	97	140-3042	93	199-383	264
136-668A	98, 99	150-240	138	199-384T	214
136-674	98, 99	150-2408	138	199-385	214
136-674D	98, 99	180-373	357	199-387	214
136-679	98, 99	180-374	357	199-390	214
136-686	95	180-375	357	199-391	214
136-686D	95	180-376	357	199-392	215
136-687	95	180-377	357	199-392T	215
136-688	95	180-378	357	199-393A	215
136-688S	95	180-379	357	199-393B	215
136-688T	97	180-380	357	199-393C	215
136-689	95	180-381	357	199-394	214
136-697	95	180-382	357	199-395	215
136-698	95	180-403	357	199-396	215
136-699	98	180-404	357	199-397	224
136-700	95	180-405	357	199-397S	224
136-730	113	180-406	357	199-398	224
136-732	114	180-407	357	199-400	216
136-735	113	180-408	357	199-401T	216

199-402T	215	201-018	239	201-168	241
199-405	217	201-020	239	201-170	241
199-406	216	201-022	239	201-172	241
199-406T	216	201-024	239	201-174	241
199-410	216	201-026	239	201-176	241
199-411	216	201-028	239	201-178	241
199-412T	217	201-030	239	201-180	241
199-413T	217	201-032	239	201-182	241
199-414	222	201-034	239	201-184	241
199-415	222	201-036	239	201-186	241
199-416	222	201-038	239	201-190	240
199-417	223	201-040	239	201-192	240
199-418	222	201-050	240	201-194	240
199-419	223	201-052	240	201-196	240
199-420	222	201-054	240	201-198	240
199-420T	220	201-056	240	201-200	240
199-421	223	201-060	240	201-202	240
199-422	222	201-062	240	201-210	240
199-424	223	201-064	240	201-212	240
199-426	222	201-066	240	201-214	240
199-428	223	201-068	240	201-216	240
199-430	222	201-070	240	201-218	240
199-432	223	201-072	240	201-220	240
199-434	222	201-074	240	201-222	240
199-436	223	201-076	240	201-230	240
199-438	222	201-078	240	201-232	240
199-440	223	201-080	240	201-234	240
199-442	222	201-082	240	201-236	240
199-444	223	201-084	240	201-240	240
199-446	222	201-086	240	201-242	240
199-448	223	201-090	240	201-244	240
199-450	222	201-092	240	201-246	240
199-452	223	201-094	240	201-260	241
199-458	222	201-096	240	201-262	241
199-460	223	201-098	240	201-264	241
199-462	222	201-100	240	201-266	241
199-464	223	201-102	240	201-268	241
199-470T	216	201-104	240	201-270	241
199-480	228, 387	201-106	240	201-272	241
199-481	228, 387	201-108	240	201-274	241
199-482	228, 387	201-110	240	201-276	241
199-483	228, 387	201-112	240	201-278	241
199-484	220	201-114	240	201-280	241
199-485	220	201-116	240	201-282	241
199-490	228, 387	201-120	241	201-284	241
199-500	23	201-122	241	201-286	241
199-501	23	201-124	241	201-288	241
199-501B	23	201-126	241	201-290	241
199-502	23	201-128	241	201-300	241
199-550	24	201-130	241	201-302	241
199-600	305	201-132	241	201-304	241
199-602	305	201-134	241	201-306	241
199-604	305	201-136	241	201-308	241
199-606	305	201-138	241	201-310	241
199-3841T	214	201-140	241	201-312	241
199-3921T	215	201-142	241	201-314	241
199-4131T	217	201-144	241	201-316	241
199-4182	223	201-146	241	201-330	238
201-002	239	201-148	241	201-332	238
201-004	239	201-150	241	201-334	238
201-006	239	201-152	241	201-336	238
201-008	239	201-154	241	201-338	238
201-010	239	201-160	241	201-350	238
201-012	239	201-162	241	201-352	238
201-014	239	201-164	241	201-354	238
201-016	239	201-166	241	201-356	238

201-358	238	207-293L	269	207-960	186
201-360	238	207-295	265	207-961	186
201-362	238	207-326	271	207-963	186
201-364	238	207-328	271	207-966	186
201-366	238	207-330	271	207-2920	274
201-380	238	207-333	271	207-2921	274
201-382	238	207-338	271	207-2922	275
201-384	238	207-340	271	207-2923	275
201-386	238	207-342	271	207-2924	266
201-388	238	207-345	271	207-2925	269
201-390	238	207-417	264	207-2928	266
201-400	238	207-418	264	207-2928T	266
201-402	238	207-419-10	264	207-2929	248
201-404	238	207-419-12	264	207-4221	263
201-406	238	207-420	262	207-4231	263
201-410	238	207-421	262	207-4232	263
201-412	238	207-422	262	207-4234	263
201-414	238	207-422L	262	207-4242	263
201-416	238	207-423	262	207-4271	263
205-700	219	207-423A	262	207-4281	263
205-800	276	207-423L	262	215-026	139
205-819	227, 386	207-424	262	215-027	139
205-820	227, 386	207-424L	262	215-028	139
205-822	227, 386	207-425	262	215-029	139
205-824	227, 386	207-426	262	215-100	267
205-826	227, 386	207-427	262	220-143	225
205-828	227, 386	207-428	262	220-145	226
205-830	227, 386	207-429	262	220-149	226
205-844	227, 386	207-431	262	220-150	226
205-846	227, 386	207-454	272	220-151	226
205-847	227, 386	207-455	272	220-152	226
205-848	227, 386	207-456	272	220-155	226
205-849	270	207-460	272	220-155L	226
205-849B	270	207-461	272	220-156	226
205-850	220	207-462	272	220-160	225
205-856	279	207-463	272	230-487	281
205-857	279	207-464	272	230-488	281
205-858	279	207-465	272	230-489L	282
205-859	279	207-466	272	230-489R	282
205-860	279	207-467	272	230-495	283
205-861	279	207-468	272	230-496	283
205-864	228	207-469	272	230-4961	283
205-865	228	207-470	272	305-910	349
205-867	280	207-471	272	315-505	412
205-870	231	207-472	272	315-505C	412
205-880	224	207-473	272	315-505S	412
205-881	224	207-474	272	315-511	413
205-882	224	207-482	272	315-513	413
205-884	224	207-484	272	315-515	413
205-885	224	207-486	272	315-524	418
205-886	224	207-488	272	315-526	417
205-907	257	207-490	272	315-527	417
205-907L	257	207-921	188	315-530	419
205-908	257	207-922	188	315-532	419
205-908L	257	207-923	188	315-534	419
205-909	257	207-924	188	315-542	295, 415
205-909L	257	207-930	259	315-544	295, 415
205-910	257	207-945	258	315-548	295, 415
205-910L	257	207-950	187	315-550	295, 415
205-912	257	207-951	187	315-559	417
207-289L	260	207-952	187	315-566	414
207-290	269	207-953	187	315-567	414
207-290L	269	207-954	187	315-569	418
207-292	269	207-955	187	315-572	419
207-292L	269	207-956	187	315-573	419
207-293	269	207-957	187	315-574	419

315-576	419	330-492	172	335-250	192
315-580	411	330-495	172	335-254	192
315-581	411	330-500	162	335-255	192
315-597	295	330-511	162	335-260	192
315-598	295	330-512	162	335-265	192
315-599	295	330-513	162	335-270	193
320-769	153	330-514	162	335-275	193
320-770	153	330-515	162	335-280	193
320-771	153	330-516	162	335-285	193
320-925	225	330-517	162	345-212	375
320-930	225	330-518	162	345-241	322
320-935	225	330-519	162	345-242	322
320-937	225	330-530	162	345-243	325
320-949	153	330-531	162	345-246	316, 327
330-020	161	330-532	162	345-246A	316, 327
330-021	161	330-533	162	345-248	375
330-022	161	330-534	162	345-249	375
330-023	161	330-535	162	345-255	374
330-024	161	330-536	162	345-256	374
330-030	161	330-537	162	345-257	374
330-031	161	330-538	162	345-264	325
330-032	161	330-539	162	345-265	325
330-033	161	330-590	162	345-266	325
330-034	161	330-591	162	345-267	325
330-035	161	330-592	162	345-279	321
330-051	158	330-593	162	345-281	316
330-054	159	330-594	162	345-283	316
330-056	159	330-595	162	345-285	316
330-058	159	330-596	162	345-287	316
330-061	158	330-597	162	345-289	316
330-070	159	330-598	162	345-289R	317, 322
330-072	159	330-599	162	345-290	320
330-074	159	330-600	162	345-291	320
330-302	169, 171	330-601	162	345-292	320
330-303	169, 171	330-602	162	345-293	320
330-304	169, 171	330-603	162	345-294	320
330-305	169, 171	330-604	162	345-300	322
330-306	169, 171	330-605	162	345-302	322
330-308	169, 171	330-606	162	345-305	317, 322
330-310	169, 171	330-607	162	345-310	325
330-312	169, 171	330-608	162	345-311	325
330-314	169, 171	330-609	162	345-312	318
330-320	175	330-630	160	345-314	318
330-322	175	330-631	160	345-315	183
330-324	175	330-632	160	345-320	327
330-326	175	330-633	160	345-322	327
330-330	175	330-634	160	345-324	327
330-336	175	330-635	160	345-326	327
330-338	175	330-636	160	345-330	327
330-460	163	330-640	160	345-332	327
330-462	163	330-641	160	345-338	326
330-464	163	330-642	160	345-345	326
330-466	163	330-643	160	345-346	326
330-468	163	330-644	160	345-350	318
330-470	163	330-645	160	345-352	318
330-472	163	330-646	160	345-400	304
330-482	172	330-650	160	345-402	304
330-483	172	330-651	160	345-405	302
330-484	172	330-652	160	345-2950	320
330-485	172	330-653	160	345-2951	320
330-486	172	330-808	407	345-2952	320
330-487	172	330-817	407	345-2953	320
330-488	172	330-818	406	345-2954	320
330-489	172	330-819	407	345-2955	320
330-490	172	335-105	182	345-2956	320
330-491	172	335-106	182	345-2957	320

345-2958	320	412-462A	302	412-688	354
345-2959	320	412-462B	302	412-688M	354
350-790	340	412-462C	302	412-689	354, 355, 356
350-805	339	412-462D	302	412-690	355
350-807	339	412-519	186	412-691	355
350-824	166	412-527	183	412-692	355
350-825	166	412-555	179	412-694	355
350-826	166	412-556	179	412-696	355
350-827	166	412-557	179	412-700	355
350-828	166	412-558	179	412-701	355
350-829	166	412-559	301	412-702	355
350-835LF	170	412-571	178	412-704	355
350-835LFB	170	412-575	178	412-705	354
350-835RT	170	412-580	182	412-706	355
350-835RTB	170	412-583	179	412-715	365
350-835ST	170	412-585	179	412-715A	365
350-835STB	170	412-667A	196	412-715B	365
350-844	344	412-667B	196	412-715C	365
350-845	343	412-667C	196	412-715D	365
350-846	343	412-667D	196	412-716	365
350-849	344	412-672H	370	412-716A	365
350-850	345	412-672-SET	370	412-717	365
350-851	341	412-673	370	412-718	365
350-5453	341	412-674	370	412-719	365
350-8451	342	412-675	370	412-724	368
350-8451S	342	412-676	370	412-727A	365
350-8452	342	412-677I	356	412-727B	365
350-8454	343	412-677L	354	412-728	365
355-265	335	412-677M	354	412-728B	365
400-226	66	412-678	354	412-729	365
400-227	66	412-678I	356	412-729B	365
400-228	66	412-678L	354	412-736-1	364
400-229	66	412-678M	354	412-736-2	364
400-230	66	412-679	356	412-736-3	364
400-231	66	412-679I	356	412-736-4	364
400-232	66	412-679L	354	412-740	369
400-233	66	412-680	354, 356	412-741	369
400-234	66	412-680I	356	412-766	391
400-235	66	412-680L	354	412-767	391
400-250	62	412-680M	354	412-768	391
400-252	62	412-681	354, 356	412-769	391
400-254	62	412-681I	356	412-770	390
400-256	62	412-681L	354	412-771	390
400-418	302	412-681M	354	412-772	390
400-426	303	412-682	354, 356	412-773	390
400-427	303	412-682I	356	412-774	390
400-427T	303	412-682L	354	412-775	390
400-4271T	303	412-682M	354	412-776	390
404-390	290	412-683	354, 356	412-777	390
404-786	296	412-683I	356	412-800	369
404-787	296	412-683L	354	412-805	369
404-788	296	412-683M	354	412-810	369
404-788U	296	412-684	354, 356	412-815	369
404-3902	290	412-684I	356	412-830	364
404-7871	296	412-684L	354	412-839	358
404-7875	296	412-684M	354	412-840	358
404-7885	296	412-685	354, 356	412-841	358
412-319	135	412-685F	362	412-844	358
412-321	135	412-685I	356	412-845	358
412-455	302	412-685L	354	412-846	358
412-456	302	412-685M	354	412-847	358
412-457	302	412-686	354, 356	412-848	358
412-458	302	412-686H	362	412-849	358
412-459	302	412-686I	356	412-850	358
412-460	302	412-686L	354	412-851	358
412-461	302	412-686M	354	412-852	358

412-853	359	465-231	205	467-378	154
412-854	359	465-231B	205	467-378S	155
412-855	359	465-232	205	467-379	154
412-856	359	465-232B	205	467-379S	155
412-857	359	465-233	205	467-380	154
412-858	359	465-233B	205	467-380S	155
412-859	359	465-234	205	467-382	154
412-860	359	465-234B	205	467-382S	155
412-861	359	465-235	205	467-384	154
412-900	363	465-235B	205	467-384S	155
412-902	363	465-236	205	467-386	154
412-904	363	465-236B	205	467-386S	155
412-906	363	465-237	205	467-388	154
412-908	363	465-237B	205	467-388S	155
412-910	363	465-238	205	467-389	154
412-5563	179	465-238B	205	467-389S	155
412-7081	360	465-239	205	467-390	154
412-7082	360	465-239B	205	467-390S	155
412-7083	360	465-240	204	467-392	154
412-7084	360	465-241	204	467-392S	155
412-7151B	365	465-242	204	467-394	154
430-375	191	465-243	204	467-394S	155
430-376	191	465-244	204	467-396	154
430-378	191	465-250	204	467-396S	155
430-379	191	465-251	204	467-398	154
430-380	190	465-252	204	467-398S	155
430-382	190	465-253	204	467-403	154
430-383	190	465-254	204	467-403S	155
430-384	190	465-260	205	467-404	154
430-386	190	465-262	205	467-404S	155
438-591	137	465-264	205	467-406	154
438-592	137	465-266	205	467-406S	155
438-630	331	465-268	205	467-408	154
438-632	331	465-270	205	467-408S	155
438-634	331	465-272	205	467-410	154
440-352	130	465-274	205	467-410HL	155
440-354	130	465-276	205	467-410S	155
440-356	130	465-278	205	467-412	154
440-358	130	465-299	203	467-412S	155
440-360	130	465-300	203	467-415	151
440-362	130	465-302	203	467-430	150
440-364	130	465-304	203	467-431	150
440-370	130	465-309	200	467-432	150
440-372	130	465-311	200	467-433	150
440-374	130	465-313	200	467-434	150
440-376	130	465-320	200	467-435	150
440-378	130	465-321	201	467-436	151
440-380	130	465-322	201	467-438	151
440-382	130	465-323	201	467-440	151
465-210	204	465-325	202	467-440XS	151
465-210-1	204	467-310	115	467-441	214
465-210-2	204	467-311	115	467-443	217
465-210-3	204	467-315	115	467-445	217
465-210-4	204	467-317	115	467-448	217
465-220	204	467-318	115	467-450	300
465-220-5	204	467-332	294, 338	467-452	300
465-220-6	204	467-370	154	467-454	300
465-220-7	204	467-370S	155	467-460	301
465-220-8	204	467-371	154	467-461	301
465-225	204	467-371S	155	467-462	301
465-225-3	204	467-372	154	467-463	302
465-225-4	204	467-372S	155	467-464	302
465-225-5	204	467-374	154	467-464A	302
465-225-6	204	467-374S	155	467-465	301
465-225-7	204	467-376	154	467-467	301
465-227	204	467-376S	155	467-505	158

467-532	184	475-170	30	475-605	319
467-533	184	475-170B	30	475-610	319
467-534T	304	475-174	20	475-615	319
467-535	178	475-175	20	475-618L	317
467-4131	151	475-184	17	475-618R	317
467-4131A	151	475-185	16	475-622	268
467-4132	151	475-186	16	475-623	268
467-4132A	151	475-187	16	475-624	268
467-4133	151	475-188	16	475-625	268
467-4133A	151	475-188B	17	475-627	234
467-4134	151	475-190	20	475-628	235
467-4341	150	475-191	20	475-630	234
467-4351	150	475-194	20	475-631L	235
467-5303	304	475-195	20	475-632R	235
467-5304	304	475-203	19	475-635	234
467-5305	304	475-204	19	475-640L	235
467-5313	304	475-207	19	475-640R	235
467-5314	304	475-208	19	475-711	172
467-5315	304	475-220	19	475-712	172
468-010	291	475-225	19	475-719	167
468-011	291	475-250	18	475-722	167
468-012	291	475-295	40	475-725	167
468-090	45	475-300	38	475-729	173
468-092	45	475-301	38, 42	475-730	173
468-094	45	475-302	38	475-731	172
468-104	44	475-304	38	475-732	172
468-140	182	475-306	39	475-734	167
468-150	184	475-307	39	475-737	167
468-155	218	475-310	43	475-739	167
468-156	218	475-320	43	475-742	167
468-160	184	475-325	44	475-745	173
468-161	186	475-330	45	475-746	173
468-163	182	475-340	292	475-747	174
468-165	182	475-345	292	475-748	174
468-515	291, 337	475-350	293	475-749	174
468-520	330	475-352	293	475-750	167
468-521	332	475-360	333	475-752	167
468-522	331	475-503	228	475-753	167
468-523	331	475-505	230	475-754	167
468-530	340	475-505A	230	475-758	174
468-535	340	475-505B	230	475-760	167
468-540	340	475-508	231	475-762	167
468-649	292	475-510	229	475-764	167
468-650	292	475-511	229	475-766	167
468-651	292	475-517	229	475-768	169
468-654	292	475-518	229	475-769	169
468-660	292	475-520	229	475-770	169
468-664	292	475-521	229	475-771	169
468-670	292	475-522	261	475-772	169
468-674	292	475-522C	261	475-773	169
469-033T	338	475-523	261	475-775	169
469-035	294, 297	475-523C	261	475-776	169
475-100	219	475-530	227	475-777	169
475-101	219	475-535	227	475-778	169
475-102	219	475-539	220	475-779	169
475-103	219	475-540	220	475-780	169
475-104	219	475-542	220	475-782	169
475-136	219	475-543	221	475-783	169
475-137	219	475-546	221	475-784	169
475-138	219	475-547	221	475-785A	168
475-140	32	475-549	221	475-785B	168
475-148	22	475-550	221	475-785C	168
475-150	22	475-552	221	475-785D	168
475-164	22	475-596	319	475-785E	168
475-168	30	475-598	319	475-785F	168
475-168B	30	475-600	319	475-785G	168



475-785G1.....	168	475-930L.....	252	502-410.....	278
475-785G2.....	168	475-940.....	234	508-523.....	367
475-785H.....	168	475-950.....	305	508-536.....	403
475-787.....	171	475-9071.....	334	508-538.....	403
475-789.....	171	475-9072.....	334	508-541.....	403
475-790.....	170	478-360.....	197	508-542.....	403
475-791.....	170	478-370.....	197	508-543.....	403
475-792.....	170	478-375.....	197	508-544.....	403
475-794.....	166	478-380.....	197	508-547.....	403
475-796.....	166	478-382.....	197	508-636.....	28
475-798.....	166	478-395.....	185	508-637.....	28
475-800.....	174	478-400.....	185	508-638.....	28
475-802.....	174	478-402.....	185	508-639.....	28
475-803.....	160	478-405.....	185	1100-090.....	71
475-804.....	160	478-768.....	168	1100-091.....	71
475-805.....	160	478-770.....	168	1100-093.....	71
475-806.....	160	478-772.....	168	1100-094.....	70
475-810.....	175	478-773.....	168	1100-096G.....	70
475-840.....	138	478-774.....	168	1100-098.....	70
475-842.....	141	478-775.....	168	1100-100.....	71
475-845.....	141	478-776.....	168	1100-101.....	71
475-846.....	140	478-778.....	168	1100-105A.....	84
475-847.....	140	478-780.....	168	1100-106.....	85
475-849.....	140	478-782.....	168	1100-106A.....	85
475-850.....	142	478-785.....	168	1100-108.....	85
475-855.....	197	478-787.....	171	1100-108D.....	84
475-878.....	249	478-788.....	171	1100-110D.....	84
475-878L.....	249	478-789.....	171	1100-122.....	79
475-880.....	248	478-790.....	171	1100-168.....	134
475-880L.....	248	478-791.....	171	1100-212.....	13
475-882.....	278	478-792.....	171	1100-214.....	13
475-884.....	246	485-422.....	206	1100-214L.....	13
475-884L.....	246	485-476.....	206	1100-216.....	14
475-885.....	245	485-479.....	207	1100-224.....	13
475-885L.....	244	485-500-SET.....	208	1100-226.....	13
475-886.....	247	485-501.....	208	1100-228.....	14
475-886L.....	247	485-502.....	208	1100-260.....	13
475-899.....	334	485-503.....	208	1100-262.....	13
475-900.....	334	485-510.....	210	1100-264.....	13
475-901.....	334	485-512.....	210	1100-265.....	13
475-902.....	334	485-514.....	210	1100-268.....	14
475-903.....	334	485-516.....	210	1100-270.....	14
475-904.....	334	485-528.....	211	1100-276.....	48
475-906.....	334	485-530.....	211	1100-282.....	48
475-908.....	334	485-580.....	209	1100-344.....	55
475-909.....	334	485-582.....	209	1100-346.....	55
475-910.....	334	485-584.....	209	1100-392.....	72
475-911.....	334	485-586.....	209	1100-407.....	107
475-912.....	334	485-588.....	209	1100-408LB.....	378
475-913.....	334	485-590.....	207	1100-408LY.....	378
475-914.....	334	485-592.....	207	1100-408MB.....	378
475-915.....	334	485-592S.....	207	1100-408MBH.....	378
475-916.....	336	485-634.....	137	1100-408MY.....	378
475-916L.....	336	485-636.....	137	1100-408MYH.....	378
475-916M.....	336	485-646.....	137	1100-408SB.....	378
475-916S.....	336	485-648.....	137	1100-408SY.....	378
475-916-SET.....	336	485-675.....	301	1100-408XSB.....	378
475-917.....	334	502-380.....	267	1100-408XSY.....	378
475-918.....	335	502-382.....	267	1100-409LG.....	378
475-920.....	255	502-384.....	267	1100-409MG.....	378
475-921.....	255	502-393T.....	223	1100-409PG.....	378
475-922.....	255	502-394.....	223	1100-409SG.....	378
475-923.....	256	502-399.....	280	1100-411-10.....	380
475-924.....	256	502-400.....	280	1100-411-11.....	380
475-925.....	251	502-405.....	280	1100-411-12.....	380
475-930.....	252	502-409.....	278	1100-411-13.....	380

1100-411-14.....	380	1103-154S.....	89	1200-062.....	54
1100-411-15.....	380	1103-170.....	310	1200-064.....	54
1100-411-16.....	380	1103-223.....	321	1200-070.....	31
1100-411-17.....	380	1103-225.....	321	1200-072.....	31
1100-411-18.....	380	1103-225C.....	323	1200-076.....	30, 31
1100-411-19.....	380	1103-226.....	321	1200-076B.....	30, 31
1100-411-20.....	380	1103-228.....	324	1200-195.....	24
1100-411-21.....	380	1103-229.....	322	1200-212.....	13
1100-411-22.....	380	1103-230.....	413	1200-214.....	13
1100-411-23.....	380	1103-232.....	323	1200-216.....	14
1100-412-24.....	380	1103-233.....	322	1200-224.....	13
1100-412-26.....	380	1103-235.....	318	1200-226.....	13
1100-412-28.....	380	1103-236.....	324	1200-228.....	14
1100-412-30.....	380	1103-237.....	324	1200-229.....	13
1100-412-33.....	380	1103-238.....	324	1200-231.....	14
1100-412-36.....	380	1103-241.....	321	1200-300.....	41
1100-412-38.....	380	1103-242.....	321	1200-310.....	40
1100-412-40.....	380	1103-500.....	382	1200-348.....	15
1100-412-43.....	380	1103-500A.....	382	1200-386.....	35
1100-412-45.....	380	1103-500B.....	382	1200-386B.....	35
1100-412-47.....	380	1103-500C.....	382	1200-387.....	35
1100-462S.....	406	1103-500D.....	382	1200-387B.....	35
1100-463.....	406	1103-500E.....	382	1200-388.....	35
1100-463S.....	406	1103-500F.....	382	1200-389.....	35
1100-466.....	374, 375	1103-500G.....	382	1200-392.....	19
1100-490.....	324	1103-500H.....	382	1200-399.....	32
1100-490C.....	323	1103-500J.....	382	1200-400.....	32
1100-491.....	323	1103-601.....	86	1200-401.....	32
1100-542.....	415	1103-604.....	86	1200-402.....	25
1100-544.....	415	1103-620.....	333	1200-407.....	24
1100-574.....	410	1103-887.....	65	1200-410.....	33
1100-576.....	410	1103-887C.....	65	1200-411.....	33
1100-577.....	410	1103-888.....	65	1200-420.....	39
1100-577S.....	410	1103-888C.....	65	1200-445.....	33
1100-578.....	416	1105-110.....	147	1200-490.....	54
1100-578A.....	416	1105-112.....	147	1200-491.....	54
1100-634.....	281	1106-070.....	412	1200-497.....	51
1100-664.....	271	1106-075.....	412	1200-499.....	54
1100-666.....	271	1106-076.....	411	1200-502.....	57
1100-668.....	270	1106-077.....	411	1200-503.....	57
1100-668B.....	270	1106-078.....	411	1200-704.....	54
1100-669.....	270	1106-079.....	411	1200-706.....	54
1100-669B.....	270	1106-080.....	410	1200-708.....	50
1100-670.....	268	1106-082.....	410	1200-712.....	13
1100-670B.....	268	1106-084.....	410	1200-713.....	13
1100-735F.....	95	1106-086.....	410	1200-714.....	13
1100-740.....	8	1106-091.....	410	1200-715.....	13
1100-741.....	8	1106-092.....	410	1200-716.....	14
1100-745.....	9	1106-190.....	313	1200-717.....	14
1100-798.....	180	1106-400.....	349	1200-764.....	58
1100-798A.....	180	1106-401.....	349	1200-766.....	58
1100-798B.....	181	1106-402.....	349	1200-775.....	55
1100-798C.....	181	1106-403.....	349	1200-776.....	55
1100-798D.....	181	1106-404.....	349	1200-776S.....	55
1100-798E.....	180	1106-0791.....	411	1200-800.....	41
1100-798F.....	180	1197-673.....	218	1200-805.....	40
1100-798H.....	380	1197-675.....	218	1200-806.....	41
1100-798S.....	180	1200-011.....	58	1200-808.....	40
1100-851.....	83	1200-011C.....	58	1200-810.....	40
1100-853.....	83	1200-020.....	55	1200-812.....	42
1100-854.....	83	1200-021.....	55	1200-830.....	20
1100-7411.....	8	1200-022.....	55	1200-831.....	20
1100-7413.....	9	1200-023.....	55	1200-840.....	33
1102-BR42.....	185	1200-025.....	57	1200-845.....	34
1103-152.....	89	1200-026.....	57	1200-846.....	34
1103-153.....	89	1200-028.....	57	1200-848.....	19

1200-849	19	2100-810	127	2300-042	63
1200-851	18	2100-812	127	2300-042S	63
1200-925	20	2100-814	127	2300-046	65
1200-930	54	2100-816	127	2300-047	65
1200-935	52	2100-835	128	2300-048	62
1200-937	51	2100-836	128	2300-049	62
1200-940	25	2100-837	128	2300-134M	64
1200-945	27	2100-838	128	2300-135M	64
1200-985	53	2100-839	128	2300-143M	64
1200-986	53	2100-840	128	2300-151M	64
1271-0151	300	2100-841	128	2300-258	66
1271-152C	300	2100-842	128	2300-298	79
1271-0154	300	2100-843	128	2300-298S	79
1271-155	300	2100-875	129	2300-300	79
1271-156	300	2200-073B	117	2300-300S	79
1271-300	183	2200-074B	117	2300-301	79
1271-301	183	2200-101	118	2300-302	79
1271-302	183	2200-101A	118	2300-302S	79
1271-307	184	2200-102	118	2300-304	79
1271-309	184	2200-102A	118	2300-304S	79
1271-310	183	2200-103	118	2300-306	79
1404-845A	297	2200-104	118	2300-306S	79
1404-845B	297	2200-105	118	2300-308	79
1404-845D	297	2200-105A	118	2300-308S	79
1404-846A	297	2200-105B	118	2300-328	83
1404-846B	297	2200-107	118	2300-350	80
1404-846D	297	2200-107P	118	2300-352	80
1463-117	203	2200-108	118	2300-354	80
1463-118	203	2200-108P	118	2300-356	80
1463-119	203	2200-109	118	2300-358	80
1463-120	203	2200-110	118	2300-360	80
1463-140	311	2200-110P	118	2300-362	80
1463-141	311	2200-111	118	2300-364	80
1463-142	311	2200-111P	118	2300-366	80
1463-143	311	2200-112	118	2300-368	80
1463-461	371	2200-113	118	2300-370	80
1463-500	361	2200-126	114	2300-372	80
1463-501	361	2200-383	113	2300-374	80
1463-503	361	2200-387	113	2300-378	81
1463-504	361	2200-389	113	2300-384S	81
1463-506	361	2200-394	113	2300-388S	81
1463-507	361	2200-396	113	2300-390S	81
1467-456	303	2200-422	137	2300-394S	81
1467-458	303	2200-424	137	2300-396S	81
1467-460	303	2200-426	137	2300-0496	65
2100-420	126	2200-437	332	2300-0497	65
2100-422	126	2200-700	100	2300-0498	65
2100-425	126	2200-750	100	2300-499	65
2100-427	126	2200-752	100	2300-516	72
2100-430	126	2200-789	113	2300-518	72
2100-432	126	2200-790	113	2300-520	72
2100-435	126	2200-1112	118	2300-521	72
2100-437	126	2200-1112P	118	2300-600	89
2100-455	124	2200-1132	118	2300-601	89
2100-456	124	2200-1133	118	2300-602	89
2100-457	124	2300-020	63	2300-604	89
2100-458	124	2300-022	63	2300-670	78
2100-459	124	2300-024	63	2300-671	78
2100-460	124	2300-026	63	2300-672	78
2100-461	124	2300-030	63	2300-673	78
2100-462	124	2300-032	63	2300-674	78
2100-466	125	2300-034	63	2300-675	78
2100-800	127	2300-036	63	2300-679	78
2100-802	127	2300-038	63	2400-010	56
2100-804	127	2300-040	63	2400-012	56
2100-806	127	2300-040S	63	2400-015	56

2400-017	56	2400-717	57	2700-5331	36
2400-043	21	2400-728	26	2700-5341	36
2400-044	21	2400-729	26	2700-5351	36
2400-045	21	2400-733	27	2700-5371	36
2400-047	21	2400-739	27	2700-5411	36
2400-049	21	2400-753	25	2700-5431	36
2400-051	21	2400-755	25	2700-5451	36
2400-053	21	2400-756	25	2700-5471	36
2400-055	21	2400-757	25	2800-0001	286
2400-057	21	2400-823	15	2800-0002	286
2400-059	21	2400-823S	15	2800-0003	286
2400-061	21	2400-824	15	2800-0004	287
2400-063	21	2400-824S	15	2800-0005	287
2400-208	48	2400-826	15	2800-0006	286
2400-209	48	2400-827	15	2800-0007	286
2400-210	48	2400-827S	15	2800-0008	286
2400-210B	48	2400-920	48	2800-0009	287
2400-211	48	2400-922	48	2800-0010	287
2400-211B	48	2400-924	48	2901-281-25	125
2400-212	48	2400-926	48	2901-281-40	125
2400-213	48	2400-928	48	46933-00	253
2400-214	48	2400-6261	46	46933-02	253
2400-215	48	2400-6271	46	46933-04	253
2400-216	48	2400-6291	46	46933-06	253
2400-217	48	2400-6311	46	46933-08	253
2400-218	48	2400-6331	46	46934-00	254
2400-324	15	2405-324	15	46934-01	254
2400-324S	15	2405-324S	15	46934-02	254
2400-326	15	2405-326	15	46934-03	254
2400-327	15	2405-327	15	46934-04	254
2400-360	55	2405-824	15	46934-05	254
2400-362	55	2405-824S	15	46934-06	254
2400-365	53	2405-826	15		
2400-367	53	2405-827	15		
2400-374	29	2600-712	64		
2400-375	29	2600-713	64		
2400-376	29	2600-714	73		
2400-377	29	2600-720	74		
2400-379	29	2600-722	74		
2400-381	29	2600-725	72		
2400-383	29	2600-728	77		
2400-383S	29	2600-914	47		
2400-385	29	2600-916	47		
2400-396	26	2700-309	366		
2400-397	26	2700-320	196		
2400-428	26	2700-390	368		
2400-433	27	2700-392	368		
2400-435	26	2700-394	368		
2400-438	27	2700-862NS	120		
2400-439	27	2700-864NS	120		
2400-440	27	2700-900	122		
2400-442	27	2700-902	122		
2400-542	47	2700-902F	122		
2400-544	47	2700-903NS	122		
2400-545	47	2700-905	122		
2400-547	47	2700-906	122		
2400-626	46	2700-908NS	122		
2400-627	46	2700-915	121		
2400-629	46	2700-920	121		
2400-631	46	2700-922	121		
2400-633	46	2700-924NS	121		
2400-710	56	2700-940	123		
2400-711	57	2700-978	123		
2400-712	56	2700-995NS	120		
2400-713	57	2700-5251	36		
2400-715	57	2700-5271	36		

A

Adamson Double-ended Hook and Retractor	219
Adson Bipolar Forceps	122
Adson Dressing Cross-Serrated Forceps	97
Adson Dressing Serrated Forceps	96
Adson Dressing TC Serrated Platform Forceps	96
Adson Forceps	137
Adson Suction	368
Adson Tissue Forceps Titanium	94
Adson Tissue Smooth Platform Forceps	98, 99
Adson Tissue TC Dust Platform Forceps	98
Adson Tissue TC Serrated Platform Forceps	93
Agris-Dingman Breast Dissector	235
Aiach-Gubisch Forceps	142
Air Injection Cannula	382
Alexander Osteotome	169, 171
Algerbrush I Corneal Rust Ring Remover Burr	388
Algerbrush II Pterygium Burr	388
Allport Mastoid Searcher	218
Allport Muscle Hook	218
Anderson Bear Claw Hook Retractor	227
Andrews Pynchon Suction	366
Anthony Suction	366
Areola Marker	
Chang Quad Areola Marker	335
Asch Septum Straightening Forceps	331

Aufricht Nasal Retractor . . . . . 269, 275  
 Aufricht Saberback Power Cut Black®  
 Scissors . . . . . 19

**B**

Baby Poole Suction . . . . . 368  
 Baby Stratte Scissors . . . . . 59  
 Backhaus Towel Forceps . . . . . 143, 144  
 Bacon Duckbill Rongeur . . . . . 418  
 Baird Chalazion Clamp Forceps . . . . . 102  
 Ballenger Bayonet Swivel Knife . . . . . 304  
 Ballenger Swivel Knife . . . . . 304  
 Barnes Mini Suction Tube . . . . . 360  
 Barraquer Cilia Forceps . . . . . 106, 119  
 Barraquer Infant Wire Speculum . . . . . 396  
 Barraquer Reverse Needle Holder . . . . . 65  
 Barraquer Wire Speculum . . . . . 394  
 Barr Double Ended Probe . . . . . 403  
 Barr Fistula Probe . . . . . 403  
 Baumgartner Needle Holder . . . . . 82  
 Bayonet Suction Tube . . . . . 363  
 Beasley-Babcock Tissue Forceps . . . . . 98  
 Beaver Blade Chuck Handle #3K . . . . . 9  
 Becker Septum Scissors . . . . . 43  
 Beer Distichia Cilia Forceps . . . . . 107  
 Bergh Cilia Forceps . . . . . 107  
 Beyer Rongeur . . . . . 295  
 Biggs Face Lift Retractor . . . . . 246  
 Biggs Mammoplasty Retractor . . . . . 244, 245, 247  
 Billeau Ear Loop/Curette . . . . . 151  
 Bipolar Cord  
 Reusable Bipolar Cord . . . . . 123  
 Biro Naevus Scissors . . . . . 23  
 Bishop-Harmon 1x2 Tissue Forceps . . . . . 110  
 Bishop-Harmon 1x2 Tissue Forceps  
 Titanium . . . . . 110  
 Bishop-Harmon Irrigation Bulb Cannula Set . . . . . 381  
 Bishop-Harmon Serrated Dressing Forceps . . . . . 119  
 Black Kaye Scissors . . . . . 18  
 Blade Holder  
 Blake Blade Holder . . . . . 9  
 Blair Hook Retractor . . . . . 227, 386  
 Blair Skin Graft Knife . . . . . 305  
 Blake Blade Holder . . . . . 9  
 Block  
 Gruber Teflon Cutting Block . . . . . 343  
 Blume Osteotome . . . . . 174  
 Bodian Lacrimal Probe Set . . . . . 400  
 Boies Nasal Fracture Elevator . . . . . 183  
 Bonaccolto Suture Forceps . . . . . 106  
 Bone Grinder . . . . . 335  
 Bone Grinder . . . . . 335  
 Bonney Tissue Forceps . . . . . 112  
 Bottle Opener . . . . . 333  
 Boucheron Ear Specula Chrome . . . . . 204  
 Bowman Lacrimal Probe . . . . . 398  
 Boynton Needle Holder . . . . . 71  
 Bracken 1x2 Fixation Forceps . . . . . 109  
 Brauer-Cottle Osteotome . . . . . 167

Brauer Rocking Nasal Chisel . . . . . 158  
 Braun Fixed Caliper . . . . . 311  
 Braun-Ralph Suction . . . . . 366  
 Breast Reduction Marker . . . . . 336  
 Breast Retractor . . . . . 251  
 Brown-Adson Tissue Forceps . . . . . 95  
 Brown Adson Tissue Forceps Titanium . . . . . 97  
 Brown-Cushing Bayonet Forceps . . . . . 115  
 Brown Forceps . . . . . 94  
 Brown Scissors . . . . . 30  
 Bruenings Tongue Depressor . . . . . 206  
 Buck Ear Hex Handle Curette . . . . . 155  
 Buck Ear Round Handle Curette . . . . . 154  
 Buck Myringotomy Knife . . . . . 302  
 Buie Fistula Probe . . . . . 403  
 Buie Suction Tube . . . . . 367  
 Burr  
 Algerbrush II Corneal Rust Ring Remover  
 Burr . . . . . 388  
 Algerbrush II Pterygium Burr . . . . . 388

**C**

Cakir Osteotome . . . . . 171  
 Caliper  
 Braun Fixed Caliper . . . . . 311  
 Castroviejo Caliper . . . . . 308, 309  
 House Ear Caliper . . . . . 311  
 Jameson Caliper . . . . . 310  
 Orthopedic Vernier Caliper . . . . . 310  
 Stahl Caliper . . . . . 311  
 Thorpe Caliper . . . . . 310  
 Cannula  
 Air Injection Cannula . . . . . 382  
 Fasanella Lacrimal Cannula . . . . . 382  
 Lacrimal Cannula . . . . . 382  
 Liposuction Cannula . . . . . 238, 239, 240, 241  
 McIntyre Lacrimal Cannula . . . . . 382  
 Severin Lacrimal Cannula . . . . . 382  
 Shaninian Lacrimal Cannula . . . . . 382  
 West Cannula . . . . . 382  
 Capener Lamina Cranked Gouge . . . . . 159  
 Carrier  
 Eyebrow Lifting Ligature Carrier . . . . . 351  
 Facia Ligature Carrier . . . . . 351  
 Sanders Brown Ligature Carrier . . . . . 351  
 Carroll Tendon Pulling Forceps . . . . . 339  
 Cartilage Crusher . . . . . 345

Cottle Cartilage Crusher . . . . . 344  
 Gubisch Cartilage Crusher . . . . . 341  
 Cartilage Cutting Block . . . . . 342  
 Cartilage Cutting Block Titanium . . . . . 341  
 Cassio Ligature Carrier . . . . . 348  
 Castroviejo Body Caliper . . . . . 309  
 Castroviejo Caliper . . . . . 308, 309  
 Castroviejo Lacrimal Dilator . . . . . 401  
 Castroviejo Lip Graft Clamp Forceps . . . . . 105  
 Castroviejo Needle Holder . . . . . 63, 67, 69  
 Castroviejo Suture 1x2 Teeth Forceps . . . . . 110, 120  
 Catalano Lacrimal Intubation Set . . . . . 399  
 Ceramic Coated Scissors . . . . . 51  
 Ceramitec Scissors . . . . . 54  
 Ceramitec Stevens Tenotomy Ergonomic  
 Spread Handle Power Cut Black®  
 Scissors . . . . . 52  
 Chadwick Scissors . . . . . 24  
 Chamberlain-Fries Retractor . . . . . 278  
 Chang Quad Areola Marker . . . . . 335  
 Chisel  
 Brauer Rocking Nasal Chisel . . . . . 158  
 Cottle Gubisch Chisel . . . . . 174  
 Hibbs Chisel . . . . . 162  
 Sontec Chisel . . . . . 163  
 Chuck Handle  
 Beaver Blade Chuck Handle #3K . . . . . 9  
 Cicherelli Rongeur . . . . . 417  
 Cilia Forceps . . . . . 106  
 Cinelli Guarded Osteotome . . . . . 167  
 Clamp . . . . . 105  
 Castroviejo Lip Graft Clamp Forceps . . . . . 105  
 Cooley Bulldog Clamp . . . . . 126  
 DeBakey Bulldog Clamp . . . . . 127  
 Dietrich Micro Bulldog Clamp . . . . . 128  
 Glover-Debakey Bulldog Clamp . . . . . 124  
 John Hopkins Bulldog Clamp . . . . . 130  
 Laparoscopic Bulldog Clamp . . . . . 125  
 Micro Sontec® Yasargil-Glover Carotid  
 Artery Bulldog Clamp . . . . . 125  
 Microvascular Clamp . . . . . 129  
 Putterman Clamp Forceps . . . . . 104  
 Serrefine Bulldog Clamp . . . . . 130  
 Towel Clamp . . . . . 147  
 Universal Microvascular Clamp . . . . . 128  
 Classic Lempert Rongeur . . . . . 295, 415  
 Cleft Palate Elevator . . . . . 185  
 Cleveland Rongeur . . . . . 417

Cobb Type Spinal Gouge . . . . . 160  
 Collier Needle Holder . . . . . 82  
 Collin Lucae Mallet . . . . . 406  
 Converse Combo Sharp/Blunt Skin Hook . . . . . 220  
 Converse Hand Retractor . . . . . 257  
 Converse Nasal Tip Skin Hook . . . . . 220  
 Converse Skin Hook . . . . . 219  
 Cook Eye Speculum . . . . . 397  
 Cook Guarded Osteotome . . . . . 171  
 Cooley and Debakey Neonatal  
 Cardiovascular Clamp . . . . . 131  
 Cooley Bulldog Clamp . . . . . 126  
 Cooley Power Cut Gold Scissors . . . . . 26  
 Cord  
 Disposable Bipolar Cord . . . . . 123  
 CORD-1001 . . . . . 123  
 CORD-2000 . . . . . 123  
 Corneal Eye Shield . . . . . 378  
 Cottle Alar Retractor . . . . . 228, 280  
 Cottle Cartilage Crusher . . . . . 344  
 Cottle Columella Clamp Forceps . . . . . 102  
 Cottle Daniel Raspatory/Packer . . . . . 184  
 Cottle-Dorsal Scissors . . . . . 40, 41  
 Cottle Double Skin Hook . . . . . 214  
 Cottle Elevator . . . . . 183  
 Cottle Gubisch Chisel . . . . . 174  
 Cottle Mucosa Knife . . . . . 301  
 Cottle Neivert Hook Retractor . . . . . 224  
 Cottle Septum Speculum . . . . . 203  
 Cottle Skin Hook . . . . . 215  
 Cottle Skin Hook Titanium . . . . . 215  
 Cottle Speculum . . . . . 202  
 Cottle Thumb Skin Hook . . . . . 226  
 Cottle-Walsham Forceps . . . . . 330  
 Coupland Suction Set . . . . . 370  
 Craig-Sheehan Retractor . . . . . 267  
 Crawford Lacrimal Intubation Set . . . . . 399  
 Crile Forceps . . . . . 136  
 Crile-Wood Needle Holder . . . . . 81  
 Cronin Cleft Palate Elevator / Dissector . . . . . 185  
 CSU Cottle Elevator . . . . . 183  
 Curette  
 Billeau Ear Loop/Curette . . . . . 151  
 Buck Ear Hex Handle Curette . . . . . 155  
 Buck Ear Round Handle Curette . . . . . 154  
 Frontal Sinus Curette . . . . . 153  
 House Curette . . . . . 152, 389  
 Martini Bone Curette . . . . . 151  
 Meyerhoefer-Chalazion Curette . . . . . 150, 388  
 Shapleigh Ear Curette . . . . . 150  
 Sontec® Excavator Curette . . . . . 153  
 Tholl Curette . . . . . 153  
 Williger Curette . . . . . 151  
 Cushing Bayonet Bipolar Forceps . . . . . 123

Cushing Bayonet Forceps . . . . . 116  
 Cushing Bipolar Forceps . . . . . 120  
 Cushing Rongeur . . . . . 419  
 Cushing Tying Forceps . . . . . 113  
 Cutting Block  
 Cartilage Cutting Block . . . . . 342  
 Cartilage Cutting Block Titanium . . . . . 341  
 Gruber Cartilage Cutting Block with Grid . . . . . 343  
 Gruber Cartilage Teflon Cutting Block with  
 Grid . . . . . 342  
 Sheen Cartilage Cutting Block with Grid . . . . . 343

**D**

Daniel Endoscopic Forehead Elevator . . . . . 197  
 Daniel-Gubisch Raspatory/Rasp . . . . . 184  
 Daniel Gubisch Rib Raspatory . . . . . 191  
 D'assumpcoa Face Lift Marker . . . . . 139  
 Davis Brain Black Silicon Spatula . . . . . 391  
 Davis Brain Spatula . . . . . 390  
 Davis Mouth Gag Frame . . . . . 211  
 Day Ear Hook . . . . . 217  
 Deaver Retractor . . . . . 262, 263  
 DeBakey Bulldog Clamp . . . . . 127  
 DeBakey Tissue Forceps . . . . . 118  
 Defourmentel Rongeur . . . . . 418  
 Depressor  
 Bruenings Tongue Depressor . . . . . 206  
 Doyen Tongue Depressor . . . . . 207  
 Schepens Scleral Depressor . . . . . 384  
 Scleral Depressor . . . . . 384  
 Sewall Tongue Depressor . . . . . 206  
 Derf Needle Holder . . . . . 76  
 Derf Needle Holder Titanium . . . . . 73  
 Deschamps Ligature Carrier . . . . . 350  
 Desmarres Chalazion Clamp Forceps . . . . . 103  
 Desmarres Lid Retractor . . . . . 276, 385  
 Desmarres Lid Retractor Autoclavable  
 Plastic . . . . . 277  
 Desmarres Lid Retractor Titanium . . . . . 277  
 Desmarres Severin Chalazion Clamp  
 Forceps . . . . . 103  
 Dietrich Micro Bulldog Clamp . . . . . 128  
 Dilator . . . . . 267  
 Castroviejo Lacrimal Dilator . . . . . 401  
 Infant Lacrimal Dilator . . . . . 401  
 Muldoon Lacrimal Dilator . . . . . 401  
 Pigtail Lacrimal Probe Dilator . . . . . 401  
 Wilder Lacrimal Dilator . . . . . 401  
 Dingman Mouth Gag Set . . . . . 208  
 Disposable Bipolar Cord . . . . . 123  
 Dissector

Agris-Dingman Breast Dissector . . . . . 235  
 Cronin Cleft Palate Elevator / Dissector . . . . . 185  
 Forehead Lifting Elevator / Dissector . . . . . 188  
 Golf Club Breast Dissector . . . . . 234  
 "J" Mammary Implant Dissector . . . . . 235  
 MacCollum-Dingman Breast Dissector . . . . . 234  
 MacCollum-Dingman Submammary  
 Dissector . . . . . 234  
 Mammary & Calf Muscle Dissector . . . . . 234  
 Masing Elevator / Dissector . . . . . 178  
 McCabe Facial Nerve Dissector . . . . . 332  
 Rosen Circular Blade Dissector . . . . . 302  
 Solz Breast Hook Dissector . . . . . 235  
 Sontec-Masing Septal Dissector . . . . . 178  
 Double Action Micro Scissors . . . . . 47  
 Double-Action SS Needle Holder . . . . . 65  
 Doyen Raspatory . . . . . 190  
 Doyen Tongue Depressor . . . . . 207

**E**

Electro Blue Coated Cushing Bayonet  
 Tissue Forceps . . . . . 116  
 Electro Blue Coated Potts-Smith Tissue  
 Forceps . . . . . 117  
 Electro Blue Coated Skinner Tissue Forceps . . . . . 117  
 Elevator  
 Boies Nasal Fracture Elevator . . . . . 183  
 Cleft Palate Elevator . . . . . 185  
 Cottle Elevator . . . . . 183  
 Cronin Cleft Palate Elevator / Dissector . . . . . 185  
 CSU Cottle Elevator . . . . . 183  
 Daniel Endoscopic Forehead Elevator . . . . . 197  
 Elevator With Suction . . . . . 196  
 Forehead Lifting Elevator / Dissector . . . . . 188  
 Freer Elevator / Mucosa Knife Round  
 Handle 4.5 mm . . . . . 182  
 Freer Elevator / Packer . . . . . 182  
 Freer Periosteal Elevator . . . . . 180, 181, 380  
 Frontal Ostium Sound Elevator . . . . . 186  
 Gubisch Suction Elevator . . . . . 197

House Ear Elevator . . . . . 182  
Joseph Massing Elevator . . . . . 182  
Joseph Periosteal Elevator . . . . . 178  
Killian Elevator . . . . . 178  
Lempert Raspatory Elevator . . . . . 186  
Masing Elevator / Dissector. . . . . 178  
Maxillary Ostium Elevator / Probe. . . . . 184  
Mcdonald Elevator. . . . . 179  
McKenty Elevator. . . . . 179  
Ostium Burnisher Elevator. . . . . 185  
Pennington Elevator . . . . . 182  
Roger Elevator. . . . . 179  
Sesamoid Cottle Elevator . . . . . 183  
Sontec® Septum Elevator / Probe . . . . . 184  
Sontec A O Type Elevator / Raspatory . . . . . 192, 193  
Sontec Cottle Elevator. . . . . 183  
Sontec S.P.T. Elevator . . . . . 179  
Woodson Elevator . . . . . 178  
Elevator With Suction . . . . . 196  
Endoscopic Forehead Lifter . . . . . 187  
Endoscopic Guidance Face Lift Retractor . . . . . 258  
Entner Ligature Carrier . . . . . 350  
Enucleation Scissors . . . . . 59  
Epker Type Osteotome . . . . . 175  
Ergonomic-Handle Bonn Suture Forceps . . . . . 111  
Ergonomic-Handle Castroviejo Suture Forceps . . . . . 111  
Erhardt Lid Clamp Forceps. . . . . 101  
Eyebrow Lifting Ligature Carrier. . . . . 351  
Eye Ribbone Retractor . . . . . 386

**F**

Facia Ligature Carrier . . . . . 351  
Fanous Gubisch Nasal Osteotome . . . . . 171  
Fanous Saberback Scissors. . . . . 35  
Farrior Ear Specula. . . . . 205  
Fasanella Lacrimal Cannula . . . . . 382  
Ferreira Breast Augmentation Retractor. 250, 252  
Ferreira Face Lift Retractor . . . . . 248  
Finger Goniometer . . . . . 309  
Finger Ring Retractor Hook . . . . . 225  
Finger Ring Skin Hook . . . . . 226  
Fisher Tonsil Knife. . . . . 301  
Flexible Neck Hook Retractor. . . . . 227, 386  
Flieringa Scleral Fixation Ring . . . . . 384  
Foman-Dorsal Scissors. . . . . 41, 42

Foman Rasp . . . . . 320  
Foman "R" Rasp . . . . . 321  
Foman TC Insert Rasp . . . . . 316  
Fomon Saberback Scissors . . . . . 32  
Forceps  
Adson Bipolar Forceps . . . . . 122  
Adson Dressing Cross-Serrated Forceps . . . . . 97  
Adson Dressing Serrated Forceps . . . . . 96  
Adson Dressing TC Serrated Platform Forceps . . . . . 96  
Adson Forceps. . . . . 137  
Adson Tissue Forceps Titanium . . . . . 94  
Adson Tissue Smooth Platform Forceps . . . . . 98, 99  
Adson Tissue TC Serrated Platform Forceps . . . . . 93  
Aiach-Gubisch Forceps. . . . . 142  
Asch Septum Straightening Forceps . . . . . 331  
Backhaus Towel Forceps. . . . . 143, 144  
Baird Chalazion Clamp Forceps . . . . . 102  
Barraquer Cilia Forceps. . . . . 106, 119  
Beasley-Babcock Tissue Forceps. . . . . 98  
Beer Distichia Cilia Forceps. . . . . 107  
Bergh Cilia Forceps . . . . . 107  
Bishop-Harmon 1x2 Tissue Forceps . . . . . 110  
Bishop-Harmon 1x2 Tissue Forceps Titanium . . . . . 110  
Bishop-Harmon Serrated Dressing Forceps . . . . . 119  
Bonaccolto Suture Forceps. . . . . 106  
Bonney Tissue Forceps. . . . . 112  
Bracken 1x2 Fixation Forceps. . . . . 109  
Brown-Adson Tissue Forceps . . . . . 95  
Brown Adson Tissue Forceps Titanium . . . . . 97  
Brown-Cushing Bayonet Forceps . . . . . 115  
Brown Forceps. . . . . 94  
Carroll Tendon Pulling Forceps. . . . . 339  
Castroviejo Lip Graft Clamp Forceps . . . . . 105  
Castroviejo Suture 1x2 Teeth Forceps. . . . . 110, 120  
Cilia Forceps . . . . . 106  
Cottle Columella Clamp Forceps . . . . . 102  
Cottle-Walsham Forceps . . . . . 330  
Crile Forceps . . . . . 136  
Cushing Bayonet Bipolar Forceps . . . . . 123

123  
Cushing Bayonet Forceps. . . . . 116  
Cushing Bipolar Forceps. . . . . 120  
Cushing Tying Forceps . . . . . 113  
DeBaKey Tissue Forceps. . . . . 118  
Desmarres Chalazion Clamp Forceps . . . . . 103  
Desmarres Severin Chalazion Clamp Forceps . . . . . 103  
Electro Blue Coated Cushing Bayonet Tissue Forceps. . . . . 116  
Electro Blue Coated Potts-Smith Tissue Forceps . . . . . 117  
Electro Blue Coated Skinner Tissue Forceps . . . . . 117  
Ergonomic-Handle Bonn Suture Forceps . . . . . 111  
Ergonomic-Handle Castroviejo Suture Forceps . . . . . 111  
Erhardt Lid Clamp Forceps. . . . . 101  
Francis Chalazion Clamp Forceps . . . . . 105  
Gillies Forceps. . . . . 100  
Girard 1x2 Fixation Forceps . . . . . 109  
Girard Corneoscleral Forceps. . . . . 110  
Gorney-Adson Forceps . . . . . 97  
Gradle Cilia Forceps . . . . . 106  
Graefe Fixation Forceps . . . . . 101  
Green Fixation Forceps. . . . . 101  
Gruenwald (Jansen) Ear Forceps . . . . . 115  
Halstead Mosquito Forceps . . . . . 132, 133  
Hartman Micro Tip Mosquito Forceps. . . . . 135  
Hartman Mosquito Forceps. . . . . 133  
Heath Chalazion Clamp Forceps . . . . . 102  
Hunt Chalazion Clamp Forceps . . . . . 102  
Iris 1x2 Tissue Forceps . . . . . 119  
Iris Dressing Forceps. . . . . 99  
Jewelers Bipolar Forceps . . . . . 121  
Jewelers Classic Forceps . . . . . 92  
Jones Towel Clamp Forceps. . . . . 105  
Kelly Forceps . . . . . 134  
Kelman & Hoffer Suture Tissue Forceps . . . . . 111

Kelman-McPherson 1x2 Tissue Forceps . . . . . 108  
Knapp Trachoma Forceps. . . . . 107  
Lahey Vulsellum Forceps . . . . . 138  
Lambert Chalazion Clamp Forceps. . . . . 102  
Lester Fixation1x2 Tissue Forceps . . . . . 109  
Lordan Chalazion Clamp Forceps. . . . . 105  
Lorna-Edna Towel Forceps . . . . . 145  
Lucae Ear Forceps. . . . . 115  
Manhattan 1x2 Tissue Forceps . . . . . 108  
Manhattan Severin 1x2 Tissue Forceps . . . . . 108  
McIndoe Dressing and Tissue Forceps . . . . . 100  
McPherson Bipolar Forceps . . . . . 121  
Micro Aneurysm Clamp Applier Forceps . . . . . 129  
Midface Dissecting Forceps . . . . . 331  
Nasal Cartilage Punch Forceps. . . . . 337  
Pierse Corneal 1x2 Forceps . . . . . 111  
Pitanguy Abdomen Marking Forceps . . . . . 138  
Pitanguy Abdominal Marking Forceps . . . . . 140  
Pitanguy Flap Grasping Forceps. . . . . 142  
Pitanguy Marking Forceps. . . . . 140  
Pitanguy Rhytidoplasty Marking Forceps . . . . . 141  
Potts-Smith Dressing Forceps. . . . . 113  
Potts-Smith Tissue Forceps. . . . . 114  
Putterman Clamp Forceps. . . . . 104  
Reul Coronary Artery Forceps. . . . . 114  
Rochester-Ochsner Forceps . . . . . 135  
Roeder Towel Forceps. . . . . 146  
Rubin Septal Morselizer Forceps . . . . . 333  
Schnidt Hemostatic Forceps. . . . . 137  
Sheen Fragment Retriever Forceps . . . . . 294, 297  
Skinner Tissue Forceps . . . . . 114  
Snellen Entropium Clamp Forceps . . . . . 105  
Sontec Eye Lid Forceps . . . . . 103  
Sontec Septal Platform Forceps . . . . . 294, 338  
Sontec Septal Platform Forceps Titanium . . . . . 338

Stern-Castroviejo Suture 1x2 Tissue Forceps . . . . . 108  
Stille-Adson Dressing Forceps . . . . . 94  
Strabismus Forceps. . . . . 109  
Swiss Cilia Forceps . . . . . 107  
Tchalekian Mammary Marker Forceps . . . . . 141  
Tessier Bone Morselizing Forceps. . . . . 332  
Tissue Bipolar Forceps . . . . . 120  
Tohoku Towel Forceps. . . . . 145  
Troutman-Colibri Suture Forceps . . . . . 111  
Ziegler Cilia Forceps . . . . . 107  
Forehead Lifting Elevator / Dissector . . . . . 188  
Foster-Gillies Needle Holder. . . . . 87  
Frame  
Davis Mouth Gag Frame . . . . . 211  
Francis Chalazion Clamp Forceps . . . . . 105  
Frazier Angled Suction . . . . . 354  
Frazier Insulated Suction . . . . . 356  
Frazier Skin Hook . . . . . 214, 219  
Frazier Straight Suction . . . . . 355  
Freeman Areola Marker . . . . . 334  
Freeman Flap Retractor . . . . . 261  
Freeman Hook Retractor . . . . . 230  
Freeman-Kaye Ceramitec Ergonomic Spread Handle Saberback Scissors. . . . . 17  
Freeman-Kaye Ergonomic Spread Handle Saberback Scissors. . . . . 16, 17  
Freeman Skin Hook . . . . . 221  
Freer Double Skin Hook. . . . . 215  
Freer Elevator / Mucosa Knife Round Handle 4.5 mm . . . . . 182  
Freer Elevator / Packer . . . . . 182  
Freer Mucosa Knife. . . . . 302  
Freer Periosteal Elevator. . . . . 180, 181, 380  
Frontal Ostium Nasal Rongeur . . . . . 291  
Frontal Ostium Sound Elevator. . . . . 186  
Frontal Sinus Curette . . . . . 153  
Fukushima Suction . . . . . 357

**G**

Gag  
Jennings Mouth Gag . . . . . 210  
G Aufricht Nasal Retractor . . . . . 274  
Gauge  
Stahl A/C Lens Gauge . . . . . 311  
Gillies Forceps . . . . . 100  
Gillies Needle Holder . . . . . 88  
Gillies Skin Hook . . . . . 214  
Gillies Skin Hook Titanium . . . . . 214  
Gil-Vernet Desmarres Retractor . . . . . 277, 385  
Girard 1x2 Fixation Forceps . . . . . 109  
Girard Corneoscleral Forceps . . . . . 110

Giunta Tungsten Carbide Serrated Scissors. . . . . 22  
Glasser Micro Needle Holder . . . . . 65  
Glover-Debakey Bulldog Clamp . . . . . 124  
Golf Club Breast Dissector . . . . . 234  
Goniometer  
Finger Goniometer. . . . . 309  
Gorney-Adson Forceps. . . . . 97  
Gorney Elevator With Suction. . . . . 197  
Gorney-Kahn Scissors . . . . . 19  
Gorney Septal Scissors . . . . . 43  
Gorney Turbinate Scissors . . . . . 39  
Gouge  
Capener Lamina Cranked Gouge . . . . . 159  
Cobb Type Spinal Gouge . . . . . 160  
Hibbs Gouge . . . . . 162  
Killian-Claus Septum Gouge . . . . . 158  
Lexer Gouge . . . . . 161  
Mini Lexer Gouge. . . . . 161  
Parkes Gouge . . . . . 158  
Sontec Micro Gouge . . . . . 160  
Walter Meniscus Gouge . . . . . 159  
Gradle Cilia Forceps . . . . . 106  
Graefe Fixation Forceps . . . . . 101  
Graft Passer Ligature Carrier . . . . . 349  
Grasper  
Ramirez Type Endoscopic Plastic Forehead Corrugator Grasper . . . . . 287  
Green Fixation Forceps . . . . . 101  
Gregory Needle Holder. . . . . 62  
Grooved Director Tongue Tie . . . . . 402  
Gross Ear Hook & Spoon. . . . . 217  
Grossman Areola Marker . . . . . 334  
Gruber Cartilage Cutting Block with Grid . . . . . 343  
Gruber CartilageTeflon Cutting Block with Grid. . . . . 342  
Gruber Ear Specula . . . . . 204  
Gruber Skin Hook . . . . . 264  
Gruber Teflon Cutting Block . . . . . 343  
Gruenwald (Jansen) Ear Forceps. . . . . 115  
Gubisch Cartilage Crusher . . . . . 341  
Gubisch Suction Elevator. . . . . 197  
Gubisch Surgical Pen Holder Set. . . . . 9  
Guthrie Hook Titanium . . . . . 217  
Guthrie Skin Hook. . . . . 216

**H**

Hajek-Kofler Bone Punch Rongeur. . . . . 290  
Hakansson Rongeur. . . . . 413  
Halsey Needle Holder. . . . . 73  
Halsey Needle Holder Titanium . . . . . 74  
Halstead Mosquito Forceps . . . . . 132, 133  
Handle  
Sontec Knife Handle #3XXL . . . . . 9

Staley Round Knurled Knife Handle . . . 9	Humby Variable Skin Hook . . . . . 221
Suction Cup Handle for Eye Shields . . . 379	Jackson Tracheal Hook . . . . . 223
Universal Adjustable Angle Knife Handle #3 . . . . . 8	Joseph Blunt Ball Tips Skin Hook . . . . 222
Wide Barrel Grip Knife Handle #3. . . . . 8	Joseph Blunt Ball Tips Skin Hook Electro Blue . . . . . 223
Haraldsson Elevator with Suction. . . . . 197	Joseph Skin Hook . . . . . 220, 222
Hartman Ear Hook . . . . . 214	Joseph Skin Hook Electro Blue. . . . . 223
Hartman Micro Tip Mosquito Forceps . 135	Kilner Deluxe Skin Hook . . . . . 221
Hartman Mosquito Forceps . . . . . 133	Kilner Skin Retractor Hook . . . . . 225
Hartmann Ear Specula . . . . . 204	Kleinert-Kutz Skin Hook . . . . . 219
Hartman Rongeur . . . . . 419	Mammaplasty & Mastectomy Hook . . . 221
Heath Chalazion Clamp Forceps . . . . . 102	Mandible Bone Hook . . . . . 225
Helveston Tissue Retractor . . . . . 387	Meyerding Skin Hook . . . . . 220
Heymann Nasal Scissors . . . . . 38, 42	Millard Thumb Retractor Hook . . . . . 226
Hibbs Chisel . . . . . 162	Modified Humby Skin Hook . . . . . 221
Hibbs Gouge. . . . . 162	O'Connor Skin Hook. . . . . 216
Holding Device	O'Connor Skin Hook Titanium . . . . . 216
Pashley Pipe Suction Tube Holding Device . 371	Pashley Hook . . . . . 218
Hook	Seltzer Dermal Biopsy Hook . . . . . 217
Adamson Double-ended Hook and Retractor . . . . . 219	Sontec® Skin Hook . . . . . 216
Allport Mastoid Searcher . . . . . 218	Sontec® Skin Hook Titanium . . . . . 216
Allport Muscle Hook . . . . . 218	Sontec Bone Hook . . . . . 225
Converse Combo Sharp/Blunt Skin Hook . 220	Sontec Freer Double Skin Titanium. . . . 216
Converse Nasal Tip Skin Hook . . . . . 220	Sontec Freer Skin Hook Titanium . . . . 215
Converse Skin Hook . . . . . 219	Sontec Tissue Twist Hook . . . . . 214
Cottle Double Skin Hook . . . . . 214	Sontec Tracheal Hook Titanium . . . . . 223
Cottle Skin Hook . . . . . 215	Thumb Ring Skin Hook . . . . . 226
Cottle Skin Hook Titanium. . . . . 215	Tyrell Skin Hook . . . . . 214
Cottle Thumb Skin Hook . . . . . 226	Hook Retractor . . . . . 229
Day Ear Hook. . . . . 217	House-Baron Suction . . . . . 365
Finger Ring Retractor Hook. . . . . 225	House Curette. . . . . 152, 389
Finger Ring Skin Hook. . . . . 226	House Ear Caliper . . . . . 311
Frazier Skin Hook . . . . . 214, 219	House Ear Elevator . . . . . 182
Freeman Skin Hook. . . . . 221	House Irrigator/Suction. . . . . 365
Freer Double Skin Hook . . . . . 215	Howard Bone Rasp Double-Ended Single-Side . . . . . 321
Gillies Skin Hook . . . . . 214	Humby Variable Skin Hook. . . . . 221
Gillies Skin Hook Titanium. . . . . 214	Hunt Chalazion Clamp Forceps . . . . . 102
Gross Ear Hook & Spoon . . . . . 217	Hyde Corneal Forceps . . . . . 110
Gruber Skin Hook . . . . . 264	
Guthrie Hook Titanium. . . . . 217	
Guthrie Skin Hook . . . . . 216	
Hartman Ear Hook. . . . . 214	

**I**

Infant Lacrimal Dilator . . . . . 401	<b>J</b>
Iris 1x2 Tissue Forceps . . . . . 119	Jabaley Scissors . . . . . 25
Iris Classic Tungsten Carbide Power Cut Gold Power Cut Black TC/PC Scissors . . . . . 56	Jackson Lacrimal Intubation Set . . . . . 399
Iris Dressing Forceps . . . . . 99	Jackson Tracheal Hook . . . . . 223
Iris Stille Classic Large Cut Out Rings Scissors . . . . . 58	Jackson Tracheal Retractor . . . . . 280
Iris Stille Classic Large Rings Scissors. . 58	Jackson Tracheal Retractor Titanium . 266
Irrigator	Jacobson Knife . . . . . 302
House Irrigator/Suction . . . . . 365	Jacobson Micro Bayonet Needle Holder . 66
	Jacobson Micro Scissors . . . . . 46
	Jacobson Super Middle Weight Needle Holder . . . . . 64
	Jacobson Super Middle Weight Needle Holder Titanium . . . . . 64
	Jaeger Lid Plate . . . . . 383
	Jaeson Caliper. . . . . 310
	Jansen-Middleton Septum Cut Through Rongeur Punch . . . . . 293
	Jansen-Middleton Septum Rongeur . 292
	Jefferson Retractor . . . . . 283
	Jennings Mouth Gag . . . . . 210
	Jeurs Lempert Neuro Rongeur . . . . . 416
	Jewelers Bipolar Forceps . . . . . 121
	Jewelers Classic Forceps . . . . . 92
	Jig
	Sontec Alar Stabilizing Jig. . . . . 221
	“J” Mammary Implant Dissector . . . . . 235
	John Hopkins Bulldog Clamp. . . . . 130
	Jones Towel Clamp Forceps . . . . . 105
	Joseph Bayonet Bone Saw . . . . . 374
	Joseph Blunt Ball Tips Skin Hook . . . . 222
	Joseph Blunt Ball Tips Skin Hook Electro Blue . . . . . 223
	Joseph Bone Saw. . . . . 374
	Joseph Massing Elevator . . . . . 182
	Joseph Nasal Knife . . . . . 304
	Joseph-Peck Saberback Classic Power Cut Gold Power Cut Black TC/PC Power Cut Scissors . . . . . 27
	Joseph Periosteal Elevator . . . . . 178
	Joseph Sharp Sharp Classic Power Cut Gold Power Cut Black Scissors. . 26
	Joseph Skin Hook . . . . . 220, 222
	Joseph Skin Hook Electro Blue . . . . . 223
	Joseph Skin Hook Titanium . . . . . 220
	Joseph Tendon Knife . . . . . 304
	<b>K</b>
	Kahn Face-Lift Scissors . . . . . 20
	Kahn-Fomon Scissors. . . . . 19
	Kasdan Hand Retractor . . . . . 257

Kawamoto Double-Ended Retractor . . . 276	<b>L</b>
Kaye Blepharoplasty Scissors . . . . . 30, 31	Lacrimal Cannula . . . . . 382
Kelly Forceps. . . . . 134	Lahey Vulsellum Forceps . . . . . 138
Kelly Power Cut Gold Power Cut Black Fistula Scissors . . . . . 28	Lambert Chalazion Clamp Forceps . . . . 102
Kelman & Hoffer Suture Tissue Forceps. 111	Langenbeck Metacarpal Saw . . . . . 375
Kelman-McPherson 1x2 Tissue Forceps. 108	Langenbeck Retractor . . . . . 260
Kerrison Punch (Occular-plasti) 40° Rongeur . 393	Laparoscopic Bulldog Clamp . . . . . 125
Kerrison Punch (Occular-plasti) 90° Rongeur . 392	LaRoe Tissue Spreader Retractor. . . . . 268
Killian-Claus Septum Gouge. . . . . 158	Larry Fistula Probe . . . . . 403
Killian Elevator. . . . . 178	Lead Hand Stabilizing Restrainer . . . . . 273
Killian Nasal Speculum . . . . . 201, 202	Lempert Raspatory Elevator . . . . . 186
Killian Septum Speculum . . . . . 200	Lester Fixation 1x2 Tissue Forceps . . . . 109
Killian (Von Eicken) Suction . . . . . 369	Levesque Neuro Rongeur. . . . . 416
Kilner Deluxe Skin Hook . . . . . 221	Lexer Gouge . . . . . 161
Kilner Skin Retractor Hook . . . . . 225	Lifter
Kistler Ear Cartilage Rasp . . . . . 317	Endoscopic Forehead Lifter . . . . . 187
Kleinert-Kutz Rongeur . . . . . 411	Sontec Forehead Lifter . . . . . 186
Kleinert-Kutz Skin Hook . . . . . 219	Ligature Carrier
Knapp Rollet Hook Retractor . . . . . 227, 386	Cassio Ligature Carrier . . . . . 348
Knapp Trachoma Forceps . . . . . 107	Deschamps Ligature Carrier . . . . . 350
Knife	Entner Ligature Carrier . . . . . 350
Ballenger Bayonet Swivel Knife. . . . . 304	Graft Passer Ligature Carrier. . . . . 349
Ballenger Swivel Knife . . . . . 304	Reverdin Needle/Ligature Carrier . . . . 348
Blair Skin Graft Knife . . . . . 305	Schmieden-Dick Ligature Carrier . . . . 350
Buck Myringotomy Knife . . . . . 302	Sontec Reverdin Blunt Needle/Ligature Carrier . . . . . 348
Cottle Mucosa Knife. . . . . 301	Tendon Passer Ligature Carrier . . . . . 349
Fisher Tonsil Knife . . . . . 301	Linderman Amputation Saw . . . . . 375
Freer Elevator / Mucosa Knife Round Handle 4.5 mm. . . . . 182	Liposuction Cannula . 238, 239, 240, 241
Jacobson Knife . . . . . 302	Little Suture Carrying Scissors . . . . . 22
Joseph Nasal Knife . . . . . 304	Lockhart Mummery Fistula Probe . . . . . 402
Nasal Sickle Knife . . . . . 301	Loop
Pashley Knife Set. . . . . 303	Billeau Ear Loop/Curette . . . . . 151
Plester First Incision Knife . . . . . 302	Lordan Chalazion Clamp Forceps . . . . 105
Politzer Ear Knife . . . . . 301	Lorna-Edna Towel Forceps . . . . . 145
Sexton-Gerzog Ear Knife . . . . . 300	Lower Lateral Cartilage Morselizer . 291, 337
Tendon Knife . . . . . 300	Lucae Ear Forceps . . . . . 115
Yasargil Arachnoid Knife . . . . . 303	Luer S-Shaped Retractor . . . . . 280
Yasargil Bayonet Arachnoid Knife Titanium . 303	Lukens Thymus Retractor. . . . . 278
Knife Handle	
Knife Handle #3. . . . . 8	
Siegel Knife Handle . . . . . 9	
Knife Handle #3 . . . . . 8	
Knight Nasal Scissors . . . . . 38	
Kratz Aspirating Wire Speculum. . . . . 395	
Kratz Barraquer Wire Speculum. . . . . 395	

Sontec Micro Mallet . . . . . 407	<b>M</b>
Maltz Single-Ended Rasp . . . . . 325	MacCollum-Dingman Breast Dissector . 234
Mammaplasty & Mastectomy Hook . . 221	MacCollum-Dingman Submammary Dissector . . . . . 234
Mammary & Calf Muscle Dissector . 234	Maltz Improved Double Ended Rasp . 318
Mandible Bone Hook . . . . . 225	Maliniac Nasal Retractor . . . . . 249
Manhattan 1x2 Tissue Forceps. . . . . 108	Malleable Ribbon Retractor . . . . . 272
Manhattan Severin 1x2 Tissue Forceps . 108	Mallet
Marker	Collin Lucae Mallet . . . . . 406
Breast Reduction Marker . . . . . 336	Sontec Combo Nylon Mallet . . . . . 406
D'assumpcoa Face Lift Marker . . . . . 139	Sontec Double Nylon Mallet . . . . . 407
Grossman Areola Marker. . . . . 334	
Marten Face Lift Marker. . . . . 139	
Sontec Areola Marker . . . . . 334	
Marten Face Lift Marker . . . . . 139	
Martini Bone Curette . . . . . 151	
Masing Elevator / Dissector . . . . . 178	
Masing Rasp . . . . . 326	
Mathieu Heavy Needle Holder . . . . . 70	
Mathieu Needle Holder . . . . . 71	
Maxillary Ostium Elevator / Probe . . . . 184	
Mayo-Carroll Scissors . . . . . 48	
Mayo-Harrington Scissors . . . . . 48	
Mayo-Hegar Needle Holder . . . . . 83	
Mayo-Sontec Retractor . . . . . 281	
McCabe Facial Nerve Dissector . . . . . 332	
McCollough Twist Fomon Raspatory . 318	
Mcdonald Elevator . . . . . 179	
McGannon Retractor . . . . . 276	
Mcllwraith Cup Rongeur. . . . . 297	
McIndoe Dressing and Tissue Forceps . 100	
Mclntyre Lacrimal Cannula . . . . . 382	
Mclvor Mouth Gag Set . . . . . 209	
McKee Eye Speculum. . . . . 396	
McKenty Elevator . . . . . 179	
McNeill-Goldman Scleral Fixation Ring & Blepharostat . . . . . 384	
McPherson Bipolar Forceps . . . . . 121	
McPherson Needle Holder . . . . . 68	
Meyerding Finger Retractor . . . . . 279	
Meyerding Skin Hook . . . . . 220	
Meyerhoefer-Chalazion Curette . 150, 388	
Micro Aneurysm Clamp Applier Forceps . 129	
Micro Friedman Ring Handle Rongeur . 411	
Micro Friedman Rongeur . . . . . 412	
Micro Plastic Surgery Osteotome. . . . . 168	
Micro Sontec® Yasargil-Glover Carotid Artery Bulldog Clamp. . . . . 125	
Microvascular Clamp . . . . . 129	
Microvascular Needle Holder . . . . . 80	
Midface Dissecting Forceps . . . . . 331	
Millard Thumb Retractor Hook . . . . . 226	
Miller Bone Rasp Double-Ended Single-Sided . . . . . 322	
Miller Bone Rasp Double-Ended Single-Sided Serrated . . . . . 322	
Miller Cross Serrated Rasp . . . . . 323	
Miller Parallel Serrated Rasp. . . . . 324	
Miller Rasp . . . . . 317, 322	
Miller Skin Rake Retractor. . . . . 228, 387	

Mini Friedman Rongeur . . . . . 412  
Mini Lexer Gouge . . . . . 161  
Mini Neuro Premier Rongeur . . . . . 410  
Mini Neuro Rongeur . . . . . 410  
Mini Rake Retractor. . . . . 228  
Modified Cottle Speculum . . . . . 202  
Modified Ferguson-Frazier Suction . . . . . 362  
Modified Humby Skin Hook . . . . . 221  
Morselizer  
Lower Lateral Cartilage Morselizer . . . . . 291, 337  
Muldoon Lacrimal Dilator . . . . . 401  
Murdoch Eye Speculum . . . . . 397

**N**

Nail Rasp . . . . . 325  
Nasal Cartilage Punch Forceps . . . . . 337  
Nasal Scissors . . . . . 44, 45  
Nasal Sickle Knife . . . . . 301  
Needle  
Reverdin Needle/Ligature Carrier . . . . . 348  
Sontec Reverdin Blunt Needle/Ligature Carrier . . . . . 348  
Wright Fascia Needle. . . . . 330  
Needle Holder  
Barraquer Reverse Needle Holder . . . . . 65  
Baumgartner Needle Holder . . . . . 82  
Boynton Needle Holder . . . . . 71  
Castroviejo Needle Holder . . . . . 63, 69  
Collier Needle Holder . . . . . 82  
Crile-Wood Needle Holder. . . . . 81  
Derf Needle Holder . . . . . 76  
Derf Needle Holder Titanium. . . . . 73  
Double-Action SS Needle Holder . . . . . 65  
Foster-Gillies Needle Holder . . . . . 87  
Gillies Needle Holder . . . . . 88  
Glasser Micro Needle Holder . . . . . 65  
Gregory Needle Holder . . . . . 62  
Halsey Needle Holder . . . . . 73  
Halsey Needle Holder Titanium. . . . . 74  
Jacobson Micro Bayonet Needle Holder . . . . . 66  
Jacobson Super Middle Weight Needle Holder . . . . . 64  
Jacobson Super Middle Weight Needle Holder Titanium . . . . . 64  
Mathieu Heavy Needle Holder. . . . . 70  
Mathieu Needle Holder . . . . . 71  
Mayo-Hegar Needle Holder. . . . . 83  
McPherson Needle Holder . . . . . 68  
Microvascular Needle Holder . . . . . 80  
Neivert Needle Holder . . . . . 77  
New Orleans Wire Twister Needle Holder . . . . . 89  
Olsen-Webster Needle Holder. . . . . 86  
Par Needle Holder . . . . . 75  
Par Needle Holder Titanium . . . . . 77  
Ramirez Type Endoscopic Plastic Facelift Needle Holder . . . . . 287  
Ryder Delicate Needle Holder. . . . . 79  
Sontec Extra Micro Needle Holder . . . . . 62  
Sontec-Olsen-Hegar Deluxe Needle

Holder. . . . . 84  
Sontec Olsen-Hegar Needle Holder . . . . . 85  
Sternal Wire Twister Needle Holder. . . . . 89  
Swedish Style Needle Holder . . . . . 78  
Webster Needle Holder . . . . . 72  
Webster Needle Holder Titanium . . . . . 72  
Neivert Anderson Guarded Osteotome . . . . . 166  
Neivert Hook Retractor . . . . . 224  
Neivert Needle Holder. . . . . 77  
Neivert Retractor . . . . . 224  
New Orleans Wire Twister Needle Holder. 89

**O**

O'Connor Skin Hook . . . . . 216  
O'Connor Skin Hook Titanium. . . . . 216  
Obwegeser Fenestrated Serrations Rasp . . . . . 327  
Obwegeser Mandib Raspatory. . . . . 191  
Obwegeser Ramus Osteotome . . . . . 174  
Olsen-Webster Needle Holder . . . . . 86  
Operating Classic, Tungsten Carbide, Power Cut Gold, Power Cut Black, TC/PC Power Cut Scissors . . . . . 13, 14  
Orthopedic Vernier Caliper . . . . . 310  
Osteotome  
Alexander Osteotome . . . . . 169, 171  
Blume Osteotome . . . . . 174  
Brauer-Cottle Osteotome. . . . . 167  
Cakir Osteotome . . . . . 171  
Cinelli Guarded Osteotome. . . . . 167  
Cook Guarded Osteotome . . . . . 171  
Epker Type Osteotome . . . . . 175  
Fanous Gubisch Nasal Osteotome . . . . . 171  
Micro Plastic Surgery Osteotome . . . . . 168  
Neivert Anderson Guarded Osteotome . . . . . 166  
Obwegeser Ramus Osteotome. . . . . 174  
Pitanguy U-Shaped Osteotome. . . . . 167  
Plastic Surgery Guarded Osteotome . . . . . 169  
Plastic Surgery Osteotome . . . . . 170  
Rees Osteotome . . . . . 172  
Rubin Nasal Osteotome. . . . . 167  
Schrom Guarded Osteotome . . . . . 170  
Silver Guarded Osteotome . . . . . 166  
Sontec Intranasal Osteotome . . . . . 173  
Sontec Nasal Dorsum Osteotome. . . . . 172  
Sontec Osteotome. . . . . 173

Sontec Pattern Plastic Osteotome. . . . . 172  
Sontec Type Lateral Osteotome . . . . . 174  
"V" Sontec Osteotome . . . . . 168  
Walter Osteotome . . . . . 175  
Ostium Burnisher Elevator . . . . . 185

**P**

Packer  
Cottle Daniel Raspatory/Packer. . . . . 184  
Freer Elevator / Packer . . . . . 182  
Parker Retractor Set . . . . . 271  
Parkes Gouge . . . . . 158  
Par Needle Holder. . . . . 75  
Par Needle Holder Titanium . . . . . 77  
Par Scissors . . . . . 25  
Pashley-Frazier Suction . . . . . 361  
Pashley Hook . . . . . 218  
Pashley Knife Set . . . . . 303  
Pashley Nasal Speculum Set . . . . . 203  
Pashley Pipe Suction Tube Holding Device . . . . . 371  
Paul Skin Rake Retractor . . . . . 228, 387  
Peers Towel Forceps. . . . . 146  
Pennington Elevator . . . . . 182  
Perkins Retractor. . . . . 281  
Pierse Corneal 1x2 Forceps . . . . . 111  
Pigtail Lacrimal Probe Dilator . . . . . 401  
Pitanguy Abdomen Marking Forceps . . . . . 138  
Pitanguy Abdominal Marking Forceps . . . . . 140  
Pitanguy Abdominal Retractor . . . . . 255, 256  
Pitanguy Elevator With Suction . . . . . 197  
Pitanguy Flap Grasping Forceps . . . . . 142  
Pitanguy Marking Forceps . . . . . 140  
Pitanguy Raspatory Elevator With Suction . . . . . 196  
Pitanguy Rhytidoplasty Marking Forceps . . . . . 141  
Pitanguy U-Shaped Osteotome . . . . . 167  
Plastic Surgery Guarded Osteotome . . . . . 169  
Plastic Surgery Osteotome. . . . . 170  
Plastic Surgery Scissors . . . . . 21  
Plester First Incision Knife. . . . . 302  
Plester Jansen Retractor. . . . . 283  
Plester Retractor Set . . . . . 282  
Politzer Ear Knife. . . . . 301  
Polokoff Bone Rasp Double-Ended Single-Sided . . . . . 321  
Poole Suction . . . . . 368  
Potts-Smith Dressing Forceps . . . . . 113  
Potts-Smith Tissue Forceps . . . . . 114  
Power Cut Black®. . . . . 51, 54  
Power Cut Gold. . . . . 51, 54  
Press  
Sheehy Gelfoam Mini Cartilage Press. . . . . 340  
Probe  
Barr Double Ended Probe . . . . . 403  
Barr Fistula Probe . . . . . 403

Bowman Lacrimal Probe . . . . . 324  
398  
Buie Fistula Probe . . . . . 403  
Larry Fistula Probe. . . . . 403  
Lockhart Mummery Fistula Probe. . . . . 402  
Maxillary Ostium Elevator / Probe. . . . . 184  
Sontec® Septum Elevator / Probe . . . . . 184  
Sontec Hook Probe Titanium . . . . . 218  
St. Marks Fistula Probe . . . . . 403  
Punch  
Ramirez Type Endoscopic Plastic Forehead Procerus Punch . . . . . 286  
Sontec Nasal Tip Cartilage Punch. . . . . 173  
Punched Hole Gauge Ruler . . . . . 313  
Putterman Clamp Forceps . . . . . 104

**R**

Ragnell Retractor . . . . . 270  
Ragnell Undermining Power Cut Gold Scissors . . . . . 29  
Rake Retractor . . . . . 224  
Ramirez Type Endoscopic Plastic Facelift Needle Holder . . . . . 287  
Ramirez Type Endoscopic Plastic Forehead Corrugator Grasper . . . . . 287  
Ramirez Type Endoscopic Plastic Forehead Procerus Punch . . . . . 286  
Ramirez Type Endoscopic Plastic Forehead Scissors . . . . . 286  
Rasp  
Daniel-Gubisch Raspatory/Rasp . . . . . 184  
Foman Rasp. . . . . 320  
Foman "R" Rasp . . . . . 321  
Foman TC Insert Rasp. . . . . 316  
Howard Bone Rasp Double-Ended Single-Side . . . . . 321  
Kistler Ear Cartilage Rasp . . . . . 317  
Maltz Improved Double Ended Rasp . . . . . 318  
Maltz Single-Ended Rasp . . . . . 325  
Masing Rasp . . . . . 326  
Miller Bone Rasp Double-Ended Single-Sided . . . . . 322  
Miller Bone Rasp Double-Ended Single-Sided Serrated . . . . . 322  
Miller Cross Serrated Rasp . . . . . 323  
Miller Parallel Serrated Rasp . . . . . 324

Miller Rasp . . . . . 317, 322  
Nail Rasp . . . . . 325  
Obwegeser Fenestrated Serrations Rasp . . . . . 327  
Polokoff Bone Rasp Double-Ended Single-Sided . . . . . 321  
Rhinoplasty Rasp. . . . . 318  
Sontec Diamond Surface Rasp . . . . . 326  
Sontec-Glabella Sculpting TC Insert Rasp . . . . . 316, 327  
Sontec Micro Rasp . . . . . 325  
Sontec-Miller TC Insert Rasp. . . . . 322  
Webster Glabella Sculpting Rasp . . . . . 316, 327  
Raspatory  
Cottle Daniel Raspatory/Packer. . . . . 184  
Daniel-Gubisch Raspatory/Rasp . . . . . 184  
Daniel Gubisch Rib Raspatory . . . . . 191  
Doyen Raspatory . . . . . 190  
Lempert Raspatory Elevator . . . . . 186  
McCullough Twist Fomon Raspatory . . . . . 318  
Obwegeser Mandib Raspatory . . . . . 191  
Sontec A O Type Elevator / Raspatory . . . . . 192, 193  
Rees Osteotome . . . . . 172  
Retractor  
Adamson Double-ended Hook and Retractor. . . . . 219  
Anderson Bear Claw Hook Retractor . . . . . 227  
Aufrecht Nasal Retractor. . . . . 269, 275  
Biggs Face Lift Retractor . . . . . 246  
Biggs Mammoplasty Retractor . . . . . 244, 245, 247  
Breast Retractor . . . . . 251  
Converse Hand Retractor . . . . . 257  
Cottle Alar Retractor . . . . . 228, 280  
Cottle Neivert Hook Retractor . . . . . 224  
Craig-Sheehan Retractor. . . . . 267  
Deaver Retractor . . . . . 262, 263  
Desmarres Lid Retractor . . . . . 276, 385  
Desmarres Lid Retractor Autoclavable Plastic. . . . . 277

Desmarres Lid Retractor Titanium. . . . . 277  
Endoscopic Guidance Face Lift Retractor . . . . . 258  
Eye Ribbon Retractor . . . . . 386  
Ferreira Breast Augmentation Retractor . . . . . 250, 252  
Ferreira Face Lift Retractor . . . . . 248  
Flexible Neck Hook Retractor . . . . . 227, 386  
Freeman Flap Retractor. . . . . 261  
Freeman Hook Retractor. . . . . 230  
G Aufrecht Nasal Retractor. . . . . 274  
Gil-Vernet Desmarres Retractor. . . . . 277, 385  
Helveston Tissue Retractor . . . . . 387  
Hook Retractor. . . . . 229  
Jackson Tracheal Retractor. . . . . 280  
Jackson Tracheal Retractor Titanium . . . . . 266  
Jefferson Retractor . . . . . 283  
Kasdan Hand Retractor. . . . . 257  
Kawamoto Double-Ended Retractor . . . . . 276  
Knapp Rollet Hook Retractor. . . . . 227, 386  
Langenbeck Retractor. . . . . 260  
LaRoe Tissue Spreader Retractor . . . . . 268  
Luer S-Shaped Retractor . . . . . 280  
Lukens Thymus Retractor . . . . . 278  
Maliniac Nasal Retractor . . . . . 249  
Malleable Ribbon Retractor. . . . . 272  
Mayo-Sontec Retractor . . . . . 281  
McGannon Retractor . . . . . 276  
Meyerding Finger Retractor. . . . . 279  
Miller Skin Rake Retractor . . . . . 228, 387  
Mini Rake Retractor . . . . . 228  
Neivert Hook Retractor . . . . . 224  
Neivert Retractor . . . . . 224  
Paul Skin Rake Retractor. . . . . 228, 387  
Perkins Retractor . . . . . 281  
Pitanguy Abdominal Retractor. . . . . 255, 256  
Plester Jansen Retractor . . . . . 283

283	293	Schrom Guarded Osteotome . . . . . 170	Reynolds Tenotomy Classic, Power Cut Gold, Power Cut Black, TC/PC Power Cut Scissors . . . . . 15	Zoellner Micro Ear Surgery Set . . . . . 189	Sontec Perfusion Cannula Suction . . . . . 369
Ragnell Retractor . . . . . 270	Jansen-Middleton Septum Rongeur . . . . . 292	Scissors	Ribbon-Handle Classic Iris Scissors . . . . . 55	Severin Lacrimal Cannula . . . . . 382	Sontec Reverdin Blunt Needle/Ligature Carrier . . . . . 348
Rake Retractor . . . . . 224	Jeurs Lempert Neuro Rongeur . . . . . 416	Aufricht Saberback Power Cut Black® Scissors . . . . . 19	Sistrunk Scissors . . . . . 33	Sewall Orbital Retractor . . . . . 383	Sontec Septal Platform Forceps . . . . . 294, 338
Richardson Retractor . . . . . 271	Kerrison Punch (Ocular-plasti) 40° Rongeur . . . . . 393	Baby Stratte Scissors . . . . . 59	Sontec Bipolar Metzenbaum Scissors . . . . . 36	Sewall Tongue Depressor . . . . . 206	Sontec Septal Platform Forceps Titanium . . . . . 338
S-Curve Retractor . . . . . 264	Kerrison Punch (Ocular-plasti) 90° Rongeur . . . . . 392	Becker Septum Scissors . . . . . 43	Sontec Double Action Micro Scissors . . . . . 47	Sexton-Gerzog Ear Knife . . . . . 300	Sontec Septum Elevator / Probe . . . . . 184
Senn Retractor . . . . . 270	Kleinert-Kutz Rongeur . . . . . 411	Biro Naevus Scissors . . . . . 23	Sontec Heifetz Micro Scissors . . . . . 47	Shaninian Lacrimal Cannula . . . . . 382	Sontec Skin Retractor . . . . . 231
Sewall Orbital Retractor . . . . . 383	Levesque Neuro Rongeur . . . . . 416	Black Kaye Scissors . . . . . 18	Sontec Nasal Scissors . . . . . 45	Shapleigh Ear Curette . . . . . 150	Sontec S.P.T. Elevator . . . . . 179
Sontec Skin Retractor . . . . . 231	Mcllwraith Cup Rongeur . . . . . 297	Brown Scissors . . . . . 30	Stevens Siegert Tenotomy Scissors Double Beveled Blades . . . . . 53	Shearer Chickenbill Rongeur . . . . . 413	Sontec Suction Wound Retractor . . . . . 253, 254
Sontec Suction Wound Retractor . . . . . 253, 254	Micro Friedman Ring Handle Rongeur . . . . . 411	Ceramitec Stevens Tenotomy Ergonomic Spread Handle Power Cut Black® Scissors . . . . . 52	Stevens Tenotomy Classic, Tungsten Carbide, Power Cut Gold, Power Cut Black®, Ceramitec Scissors . . . . . 54	Sheehy Gelfoam Mini Cartilage Press . . . . . 340	Sontec Tissue Twist Hook . . . . . 214
Sontec-Yancoskie Coronal Lift Retractor . . . . . 231	Micro Friedman Rongeur . . . . . 412	Chadwick Scissors . . . . . 24	Stevens Tenotomy Ergonomic Spread Handle Tungsten Carbide Power Cut Black/Gold Scissors . . . . . 51	Sheen Cartilage Cutting Block with Grid. . . . . 343	Sontec Tracheal Hook Titanium . . . . . 223
Trousseau Tracheal Dilator Retractor . . . . . 267	Mini Neuro Premier Rongeur . . . . . 410	Cooley Power Cut Gold Scissors . . . . . 26	Stevens Tenotomy , Tungsten Carbide, Power Cut Gold, Power Cut Black®, Ceramic Coated Scissors . . . . . 51	Sheen Fragment Retriever Forceps. . . . . 294, 297	Sontec Type Lateral Osteotome . . . . . 174
Walter Aufricht Nasal Retractor . . . . . 266	Mini Neuro Rongeur . . . . . 410	Cottle-Dorsal Scissors . . . . . 40, 41	Strabismus Classic Tungsten Carbide Power Cut Gold Power Cut Black Scissors . . . . . 55	Siegel Knife Handle . . . . . 9	Sontec Universal Bottle Opener . . . . . 333
Walter Aufricht Nasal Retractor Titanium . . . . . 266	Shearer Chickenbill Rongeur . . . . . 413	Double Action Micro Scissors . . . . . 47	Swedish Gradle Scissors . . . . . 24	Silicone Eye Implants . . . . . 380	Sontec-Yancoskie Coronal Lift Retractor. . . . . 231
Walter Forehead Retractor . . . . . 259	Sontec Dynamic Punch Rongeur . . . . . 290	Enucleation Scissors . . . . . 59	Taylor Dura Scissors . . . . . 24	Silver Guarded Osteotome . . . . . 166	Spatula
Blair Hook Retractor . . . . . 227, 386	Sontec Lempert Rongeur . . . . . 415	Fanouus Saberback Scissors . . . . . 35	Titanium Westcott Tenotomy Scissors . . . . . 50	Sistrunk Scissors . . . . . 33	Davis Brain Black Silicon Spatula . . . . . 391
U.S. Army-Navy Retractor . . . . . 268	Stellbrink Rongeur . . . . . 414	Foman-Dorsal Scissors . . . . . 41, 42	Trepsat Face-Lift Scissors . . . . . 20	Skinner Tissue Forceps . . . . . 114	Davis Brain Spatula . . . . . 390
Retractor, Senn . . . . . 270	Takahashi Rongeur . . . . . 296	Fomon Saberback Scissors . . . . . 32	Westcott Stitch Scissors . . . . . 49	Smith-Petersen Gouge . . . . . 160	Specula
Reul Coronary Artery Forceps . . . . . 114	Weil Cut-Through Rongeur . . . . . 292	Freeman-Kaye Ceramitec Ergonomic Spread Handle Saberback Scissors . . . . . 17	Westcott Tenotomy Scissors . . . . . 49	Snellen Entropium Clamp Forceps . . . . . 105	Boucheron Ear Specula Chrome . . . . . 204
Reusable Bipolar Cord . . . . . 123	Rosen Circular Blade Dissector . . . . . 302	Freeman-Kaye Ergonomic Spread Handle Saberback Scissors . . . . . 16, 17	Westcott Wide Handle Tenotomy Scissors . . . . . 49	Solz Breast Hook Dissector . . . . . 235	Farrior Ear Specula . . . . . 205
Reverdin Needle/Ligature Carrier . . . . . 348	Ross Sump Suckers . . . . . 368	Giunta Tungsten Carbide Serrated Scissors . . . . . 22	Wilkinson Rhytidectomy Scissors . . . . . 18	Sonnenschein Nasal Speculum . . . . . 200	Gruber Ear Specula . . . . . 204
Reynolds Tenotomy Classic, Power Cut Gold, Power Cut Black, TC/PC Power Cut Scissors . . . . . 15	Rubin Nasal Osteotome . . . . . 167	Iris Classic Tungsten Carbide Power Cut Gold Power Cut Black TC/PC Scissors . . . . . 56	Scissors	Sontec® Excavator Curette . . . . . 153	Hartmann Ear Specula . . . . . 204
Rhinoplasty Rasp . . . . . 318	Rubin Septal Morselizer Forceps . . . . . 333	Iris Stille Classic Large Rings Scissors . . . . . 58	Iris Classic Tungsten Carbide Power Cut Gold Power Cut Black TC/PC Scissors . . . . . 56	Sontec® Skin Hook . . . . . 216	Speculum
Rhoton Micro Neuro Suction . . . . . 358	Ruler	Jabaley Scissors . . . . . 25	Iris Stille Classic Large Rings Scissors . . . . . 58	Sontec® Skin Hook Titanium . . . . . 216	Barraquer Infant Wire Speculum . . . . . 396
Ribbon-Handle Classic Iris Scissors . . . . . 55	Punched Hole Gauge Ruler . . . . . 313	Jacobson Micro Scissors . . . . . 46	Jabaley Scissors . . . . . 25	Sontec Alar Stabilizing Jig . . . . . 221	Barraquer Wire Speculum . . . . . 394
Richardson Retractor . . . . . 271	Ryder Delicate Needle Holder . . . . . 79	Joseph-Peck Saberback Classic Power Cut Gold Power Cut Black TC/PC Power Cut Scissors . . . . . 27	Joseph Sharp Sharp Classic Power Cut Gold Power Cut Black Scissors . . . . . 26	Sontec A O Type Elevator / Raspatory . . . . . 192, 193	Cook Eye Speculum . . . . . 397
Rochester-Ochsner Forceps . . . . . 135	<b>S</b>	Joseph Sharp Sharp Classic Power Cut Gold Power Cut Black Scissors . . . . . 26	Kahn Face-Lift Scissors . . . . . 20	Sontec Areola Marker . . . . . 334	Cottle Eye Speculum . . . . . 397
Roeder Towel Forceps . . . . . 146	Sanders Brown Ligature Carrier . . . . . 351	Kahn-Fomon Scissors . . . . . 19	Kahn Face-Lift Scissors . . . . . 20	Sontec Bipolar Metzenbaum Scissors . . . . . 36	Cottle Septum Speculum . . . . . 203
Roger Elevator . . . . . 179	Sauer Lid Speculum . . . . . 396	Kaye Blepharoplasty Scissors . . . . . 30, 31	Kahn-Fomon Scissors . . . . . 19	Sontec Bone Hook . . . . . 225	Cottle Speculum . . . . . 202
Rongeur	Saw	Kelly Power Cut Gold Power Cut Black Fistula Scissors . . . . . 28	Kaye Blepharoplasty Scissors . . . . . 30, 31	Sontec Chisel . . . . . 163	Killian Nasal Speculum . . . . . 201, 202
Bacon Duckbill Rongeur . . . . . 418	Joseph Bayonet Bone Saw . . . . . 374	Knight Nasal Scissors . . . . . 38	Kelly Power Cut Gold Power Cut Black Fistula Scissors . . . . . 28	Sontec Combo Nylon Mallet. . . . . 406	Killian Septum Speculum . . . . . 200
Beyer Rongeur . . . . . 295	Joseph Bone Saw . . . . . 374	Littler Suture Carrying Scissors . . . . . 22	Knight Nasal Scissors . . . . . 38	Sontec Cottle Elevator . . . . . 183	Kratz Aspiring Wire Speculum . . . . . 395
Cicherelli Rongeur . . . . . 417	Joseph Bone Saw . . . . . 374	Mayo-Carroll Scissors . . . . . 48	Littler Suture Carrying Scissors . . . . . 22	Sontec Diamond Surface Rasp . . . . . 326	Kratz-Barraquer Wire Speculum . . . . . 395
Classic Lempert Rongeur . . . . . 295, 415	Langenbeck Metacarpal Saw . . . . . 375	Mayo-Harrington Scissors . . . . . 48	Mayo-Carroll Scissors . . . . . 48	Sontec Double Action Micro Scissors . . . . . 47	McKee Eye Speculum . . . . . 396
Cleveland Rongeur . . . . . 417	Linderman Amputation Saw . . . . . 375	Nasal Scissors . . . . . 44, 45	Mayo-Harrington Scissors . . . . . 48	Sontec Double Nylon Mallet . . . . . 407	Modified Cottle Speculum . . . . . 202
Cushing Rongeur . . . . . 419	Wellenschliff Nasal Saw . . . . . 375	Operating Classic, Tungsten Carbide, Power Cut Gold, Power Cut Black, TC/PC Power Cut Scissors . . . . . 13, 14	Nasal Scissors . . . . . 44, 45	Sontec Dynamic Punch Rongeur . . . . . 290	Murdoch Eye Speculum . . . . . 397
Defourmentel Rongeur . . . . . 418	Schepens Scleral Depressor . . . . . 384	Par Scissors . . . . . 25	Operating Classic, Tungsten Carbide, Power Cut Gold, Power Cut Black, TC/PC Power Cut Scissors . . . . . 13, 14	Sontec Ear Rasp Set . . . . . 319	Sauer Lid Speculum . . . . . 396
Frontal Ostium Nasal Rongeur . . . . . 291	Schiotz Tonometer . . . . . 312	Plastic Surgery Scissors . . . . . 21	Par Scissors . . . . . 25	Sontec Excavator Curette . . . . . 153	Sonnenschein Nasal Speculum . . . . . 200
Hajek-Kofler Bone Punch Rongeur . . . . . 290	Schmid Suction Tips . . . . . 364	Ragnell Undermining Power Cut Gold Scissors . . . . . 29	Plastic Surgery Scissors . . . . . 21	Sontec Extra Micro Needle Holder . . . . . 62	Tieck-Halle Infant Nasal Speculum . . . . . 200
Hakansson Rongeur . . . . . 413	Schmieden-Dick Ligature Carrier . . . . . 350	Ramirez Type Endoscopic Plastic Forehead Scissors . . . . . 286	Ragnell Undermining Power Cut Gold Scissors . . . . . 29	Sontec Eye Lid Forceps . . . . . 103	
Hartman Rongeur . . . . . 419	Schnidt Hemostatic Forceps . . . . . 137		Ramirez Type Endoscopic Plastic Forehead Scissors . . . . . 286	Sontec Forehead Lifter . . . . . 186	
Jansen-Middleton Septum Cut Through Rongeur Punch . . . . . 293				Sontec Freer Double Skin Titanium . . . . . 216	

Staley Round Knurled Knife Handle . . . . .	9	368	Towel Clamp . . . . .	147
Stellbrink Rongeur . . . . .	414	Schmid Suction Tips . . . . .	Trepsat Face-Lift Scissors . . . . .	20
Sternal Wire Twister Needle Holder . . . . .	89	364	Trousseau Tracheal Dilator Retractor . . . . .	267
Stern-Castroviejo Suture 1x2 Tissue Forceps . . . . .	108	Sontec Neuro Suction . . . . .	Troutman-Colibri Suture Forceps . . . . .	111
Stevens Siegert Tenotomy Scissors Double Beveled Blades . . . . .	53	359	Tungsten Carbide . . . . .	51, 54
Stevens Tenotomy . . . . .	51	Sontec Perfusion Cannula Suction . . . . .	Tyrell Skin Hook . . . . .	214
Stevens Tenotomy Classic . . . . .	54	369		
Stevens Tenotomy Classic PC Gold Scissors . . . . .	50	Yankauer Suction . . . . .		
Stevens Tenotomy Ergonomic Spread Handle Power Cut Black Scissors . . . . .	50	367		
Stevens Tenotomy Ergonomic Spread Handle Tungsten Carbide Power Cut Black/Gold Scissors . . . . .	51	Suction Cup Handle for Eye Shields . . . . .	<b>U</b>	
Stille-Adson Dressing Forceps . . . . .	94	379	Universal Adjustable Angle Knife Handle #3. . . . .	8
St. Marks Fistula Probe . . . . .	403	Suction Tube	Universal Microvascular Clamp . . . . .	128
Strabismus Classic Tungsten Carbide Power Cut Gold Power Cut Black Scissors . . . . .	55	Barnes Mini Suction Tube . . . . .	U.S. Army-Navy Retractor . . . . .	268
Strabismus Forceps . . . . .	109	360		
Stripper		Bayonet Suction Tube . . . . .		
Tendon Stripper . . . . .	340	363		
Suction		Buie Suction Tube . . . . .		
Adson Suction . . . . .	368	367		
Andrews Pynchon Suction . . . . .	366	Swedish Gradle Scissors . . . . .	<b>V</b>	
Anthony Suction . . . . .	366	24	"V" Sontec Osteotome . . . . .	168
Baby Poole Suction . . . . .	368	Swedish Style Needle Holder . . . . .		
Braun-Ralph Suction . . . . .	366	78		
Frazier Angled Suction . . . . .	354	Swiss Cilia Forceps . . . . .	<b>W</b>	
Frazier Insulated Suction . . . . .	356	107	Walter Aufricht Nasal Retractor . . . . .	266
Frazier Straight Suction . . . . .	355		Walter Aufricht Nasal Retractor Titanium . . . . .	266
Fukushima Suction . . . . .	357		Walter Forehead Retractor . . . . .	259
Gorney Elevator With Suction . . . . .	197	<b>T</b>	Walter Meniscus Gouge . . . . .	159
Haraldsson Elevator with Suction . . . . .	197	T10-1010C . . . . .	Walter Osteotome . . . . .	175
House-Baron Suction . . . . .	365	394	Webster Glabella Sculpting Rasp . . . . .	316, 327
House Irrigator/Suction . . . . .	365	T10-4198 . . . . .	Webster Needle Holder . . . . .	72
Killian (Von Eicken) Suction . . . . .	369	277	Webster Needle Holder Titanium . . . . .	72
Modified Ferguson-Frazier Suction . . . . .	362	T10-4255 . . . . .	Weil Cut-Through Rongeur . . . . .	292
Pashley-Frazier Suction . . . . .	361	277	Wellenschliff Nasal Saw . . . . .	375
Pitanguy Elevator With Suction . . . . .	197	T12-9300 . . . . .	West Cannula . . . . .	382
Pitanguy Raspatory Elevator With Suction . . . . .	196	308	Westcott Stitch Scissors . . . . .	49
Poole Suction . . . . .	368	T14-5200 . . . . .	Westcott Tenotomy Scissors . . . . .	49
Rhoton Micro Neuro Suction . . . . .	358	101	Westcott Wide Handle Tenotomy Scissors . . . . .	49
Ross Sump Suckers . . . . .		T14-5220 . . . . .		
		101		
		T14-6303 . . . . .	Wide Barrel Grip Knife Handle #3 . . . . .	8
		106, 119	Wieder Tongue Depressor . . . . .	207
		106	Wilder Lacrimal Dilator . . . . .	401
		T14-6500 . . . . .	Wilkinson Rhytidectomy Scissors . . . . .	18
		106	Williger Curette . . . . .	151
		T14-6510 . . . . .	Wire Twister	
		92	New Orleans Wire Twister Needle Holder . . . . .	89
		T14-9850 . . . . .	Sternal Wire Twister Needle Holder . . . . .	89
		102	Woodson Elevator . . . . .	178
		T14-9906 . . . . .	Wright Fascia Needle . . . . .	330
		103		
		T14-9907 . . . . .	<b>Y</b>	
		103	Yankauer Suction . . . . .	367
		T14-9908 . . . . .	Yasargil Arachnoid Knife . . . . .	303
		103	Yasargil Bayonet Arachnoid Knife Titanium . . . . .	303
		T15-1320 . . . . .		
		68	<b>Z</b>	
		T15-1320R . . . . .	Ziegler Cilia Forceps . . . . .	107
		68	Zoellner Micro Ear Surgery Set . . . . .	189
		T15-1330 . . . . .		
		68		
		T15-1330R . . . . .		
		68		
		T115-450 . . . . .		
		136		
		T117-500 . . . . .		
		143		
		T117-560 . . . . .		
		9		
		T136-686 . . . . .		
		97		
		T2300-048 . . . . .		
		62		
		Takahashi Rongeur . . . . .		
		296		
		Taylor Dura Scissors . . . . .		
		24		
		Tchalekian Mammary Marker Forceps . . . . .		
		141		
		Tendon Knife . . . . .		
		300		
		Tendon Passer Ligature Carrier . . . . .		
		349		
		Tendon Stripper . . . . .		
		340		
		Tessier Bone Morselizing Forceps . . . . .		
		332		
		Tholl Curette . . . . .		
		153		
		Thorpe Caliper . . . . .		
		310		
		Thumb Ring Skin Hook . . . . .		
		226		
		Tieck-Halle Infant Nasal Speculum . . . . .		
		200		
		Tissue Bipolar Forceps . . . . .		
		120		
		Titanium Westcott Tenotomy Scissors . . . . .		
		50		
		Tohoku Towel Forceps . . . . .		
		145		
		Tongue Tie		
		Grooved Director Tongue Tie . . . . .		
		402		
		Tonometer		
		Schiotz Tonometer . . . . .		
		312		





Bringing the Highest Quality Surgical  
Instrumentation to the World since 1970



**Sontec Instruments®**

A TRADITION OF FINE SURGICAL INSTRUMENTS

Sontec Instruments, Inc.  
7248 South Tucson Way  
Centennial, Colorado 80112 USA  
Toll-free / 800.821.7496  
Local / 303.790.9411  
Fax / 303.792.2606

[SontecInstruments.com](http://SontecInstruments.com)